

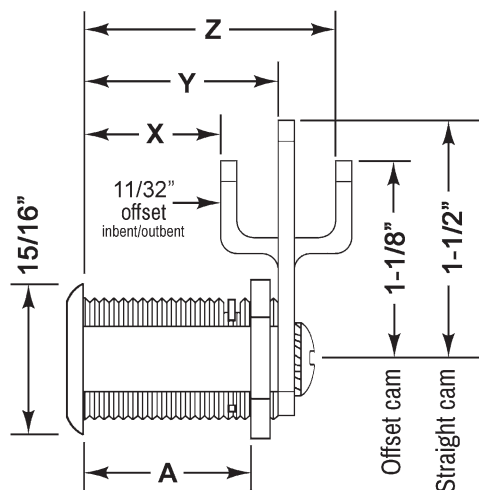

Cam Lock Dimensions

Item	Cylinder Length/ Straight Cam (Y)	Max. Mat. Thickness (A)	Inbent Cam (X)	Outbent Cam (Z)
954	15/16"	5/8"	19/32"	1-9/32"
953	1-3/16"	7/8"	27/32"	1-17/32"
955	1-7/16"	1-1/8"	1-3/32"	1-25/32"
960	1-3/4"	1-7/16"	1-13/32"	2-3/32"
961	2"	1-13/16"	1-21/32"	2-11/32"



Typical Installation

See *Cam Lock Dimensions* chart for specific installed dimensions.

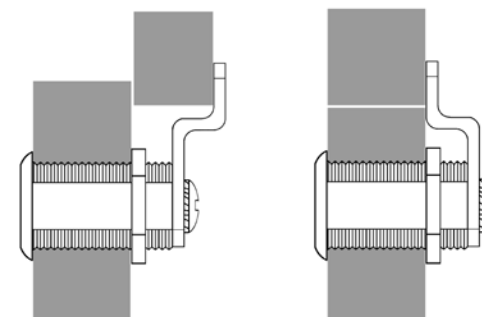

Overlay*

Flush

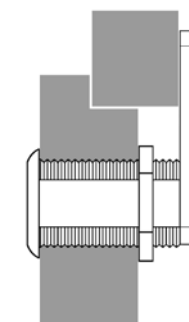

Lipped/Overlay

*Overlay installation is not recommended for particleboard.

Included Accessories:

- 2 ea. nickel plated keys
- 1 ea. fixing nut
- 1 ea. 1-1/2" straight cam
- 1 ea. 1-1/8" x 11/32" offset cam
- 1 ea. eyelet spur washer
- 1 ea. trim collar
- 1 ea. cam screw
- 1 ea. star washer

Cylinder Mounting Holes

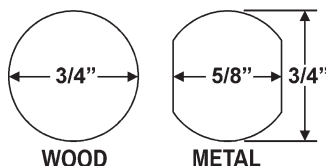

WOOD

METAL

Eyelet spur washer to be used in wood applications only.

Standard Cams

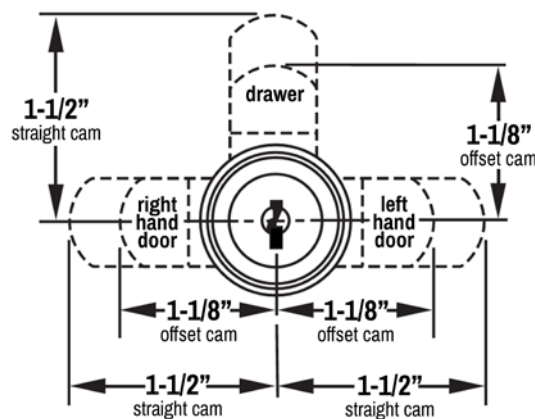

Dimensional offset of 1-1/8" cam is 11/32"

90 degree cam rotation.
Key removable in locked and unlocked position.

Cascade Series Cam Locks — 953, 954, 955, 960 & 961

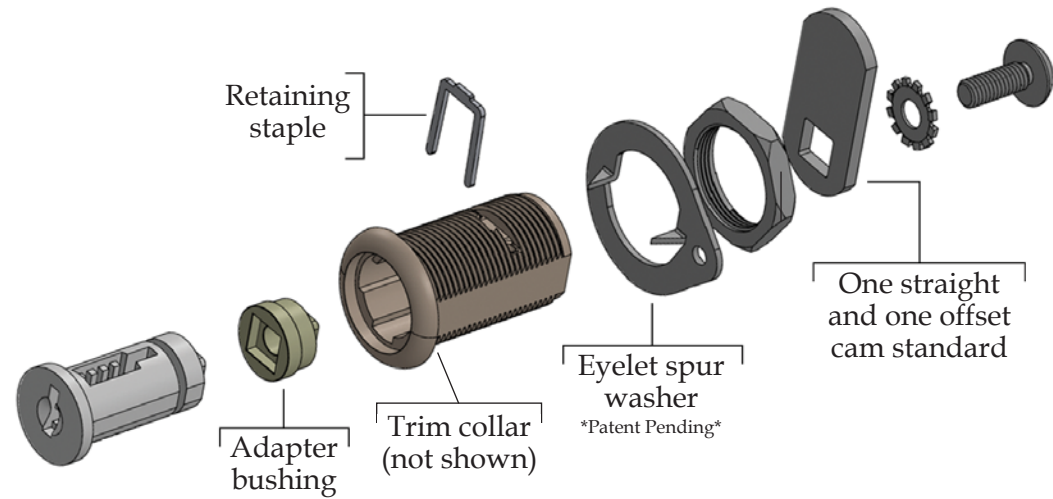
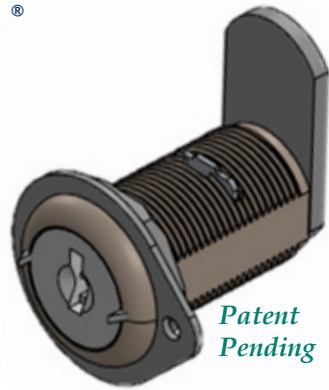

Standard and optional cam dimensions

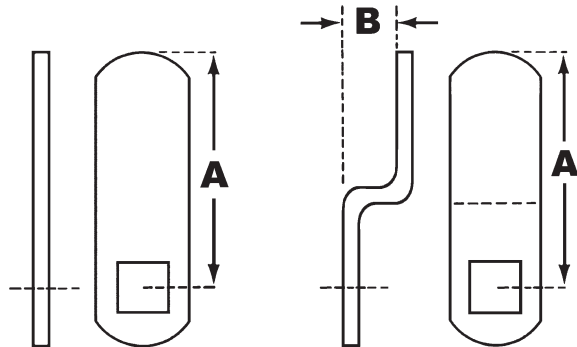

90 degree cam rotation.
Key removable in locked and unlocked position.

Straight Cams

Part No.	Dim. A [length]	Description
P95-CM-1 **	1-1/2"	Straight cam
P95-CM-3	3"	Straight cam
P95-CM-5	1-1/2"	Straight hook cam
P95-CM-6	1"	Straight cam

Offset Cams

Part No.	Dim. A [length]	Dim. B [offset]	Description
P95-CM-2 **	1-1/8"	11/32"	Offset cam
P95-CM-4	1-5/8"	5/16"	Offset cam

** P95-CM-1 and P95-CM-2 are included standard with each disc tumbler cam lock. All other cams are available separately.