

# OTOFIX









Powered by **AUTEL**  
Web: [www.otofixtech.com](http://www.otofixtech.com)

## Quick Reference Guide

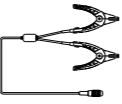
OTOFIX BT1

Thank you for purchasing this OTOFIX BT1 Smart Touchscreen Battery Analyzer. This tool is used for testing 6- and 12-volt automotive batteries as well as 12- and 24-volt cranking/charging systems.

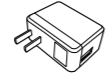
### Accessories

Main Unit 	1pc	OTOFIX V1 (optional) 	1pc	Battery Clamp Cable 	1pc	Paper Roll 	2pcs
Battery Side Post Terminal TYPE T (optional) 	2pcs	Battery Side Post Terminal TYPE S (optional) 	2pcs	Power Adapter 	1pc	USB Cable 	1pc

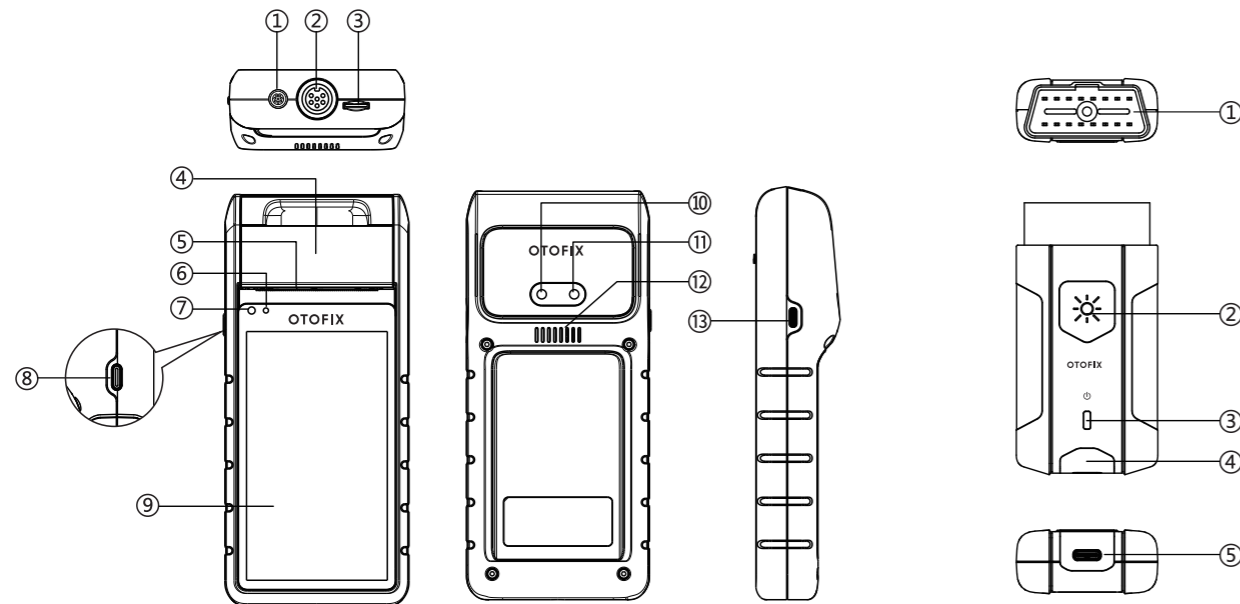

### OTOFIX BT1

- 1. Multimeter Cable Port
- 2. Battery Clamp Cable Port
- 3. Micro SD Slot
- 4. Thermal Printer
- 5. Paper Exit
- 6. Status Light
- 7. Ambient Light Sensor
- 8. Lock/Power Button
- 9. 5.5-inch Touchscreen

### OTOFIX V1

- 1. Vehicle Data Connector (16-pin)
- 2. Flashlight Power Button
- 3. Power LED
- 4. Vehicle/Connection LED
- 5. USB Port
- 10. Camera
- 11. Camera Flash
- 12. Loudspeaker
- 13. USB Port

### Safety Instructions

The safety messages herein cover situations Autel Intelligent Technology Corp. Ltd. is aware of. The company cannot know, evaluate or advise you as to all of the possible hazards. You must be certain that any condition or service procedure encountered does not jeopardize your personal safety.

#### **⚠ DANGER**

When an engine is operating, keep the service area **WELL VENTILATED** or attach a building exhaust removal

system to the engine exhaust system. Engines produce carbon monoxide, an odorless, poisonous gas that causes slower reaction time and can lead to serious personal injury or loss of life.

#### **⚠ SAFETY WARNINGS**

- Wear safety glasses and protective clothing.
- NEVER smoke or allow a spark or flame in the vicinity of battery or engine.
- If battery acid contacts skin or clothing, wash immediately with soap and water. If acid contacts the eye, immediately flush eye with cold running water for at least ten minutes and get medical attention immediately.
- Use caution when working with metallic tools to prevent sparks or short circuits.

vent sparks or short circuits.

- Remove any jewelry or watches before you start servicing the battery.
- Keep hair, hands, and clothing as well as tester leads and cords away from moving blades and belts.

#### **Inspect the Battery**

Before starting a test, observe the battery for:

- Cracking, buckling or leaking. If you see any of these defects, replace the battery.
- Corroded, loose or damaged cables and connections. Repair or replace them as needed.
- Corrosion on the battery terminals, and dirt or acid on the case top. Clean the case and terminals using a wire brush and a mixture of water and baking soda.

### Connect to a Battery

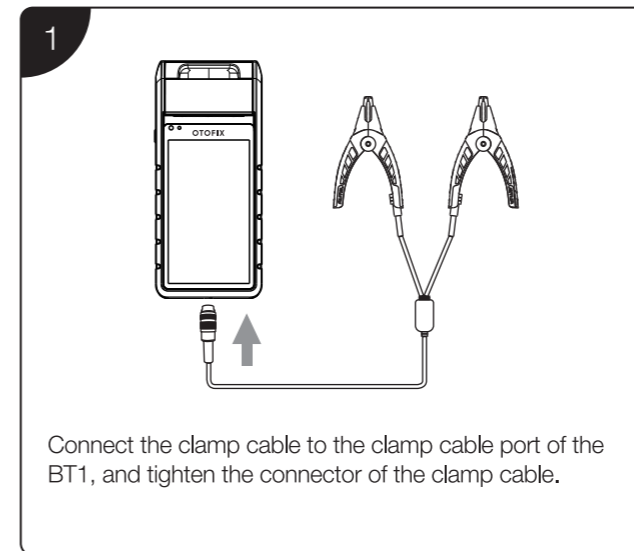

Connect the clamp cable to the clamp cable port of the BT1, and tighten the connector of the clamp cable.

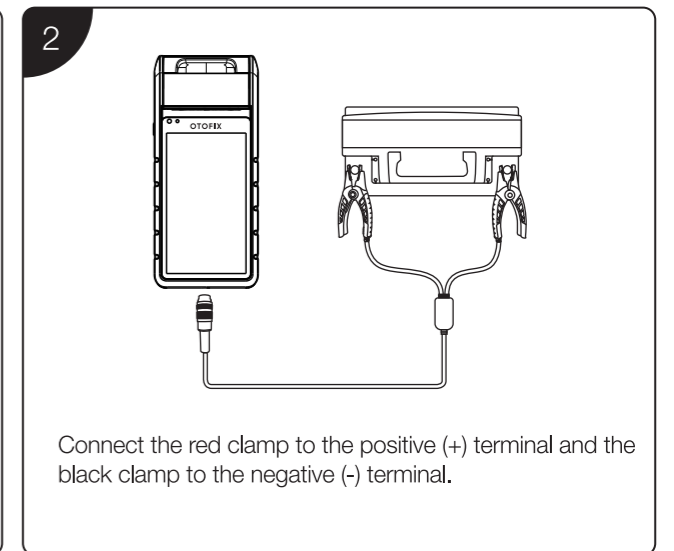

Connect the red clamp to the positive (+) terminal and the black clamp to the negative (-) terminal.

### Establish Vehicle Communication

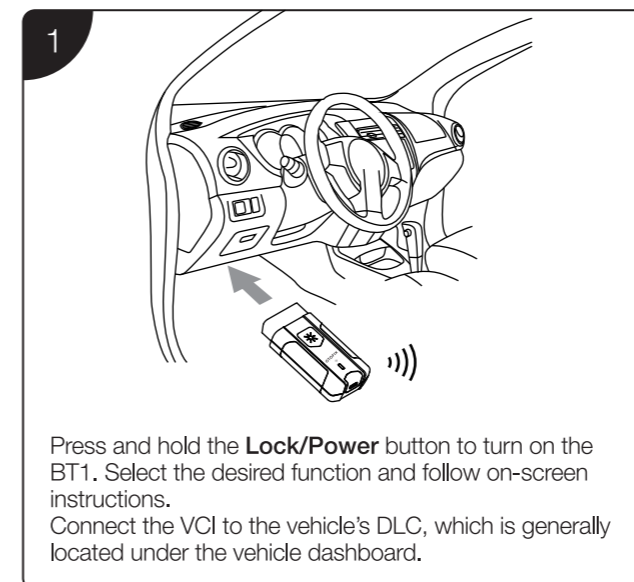

Press and hold the **Lock/Power** button to turn on the BT1. Select the desired function and follow on-screen instructions. Connect the VCI to the vehicle's DLC, which is generally located under the vehicle dashboard.

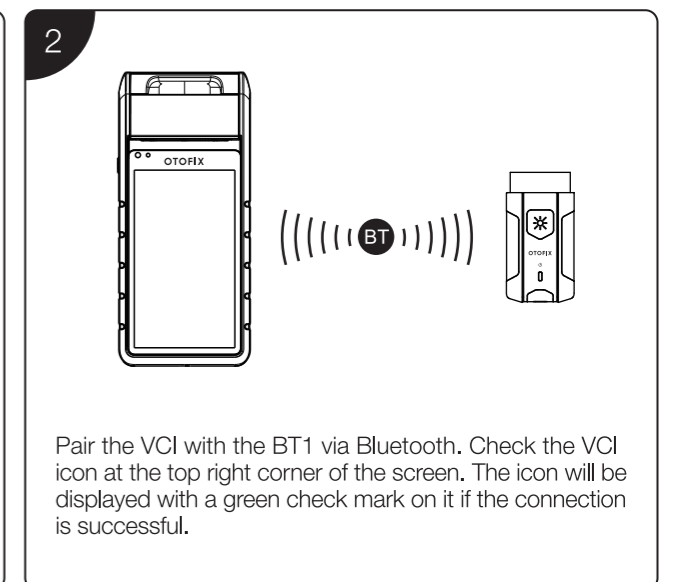

Pair the VCI with the BT1 via Bluetooth. Check the VCI icon at the top right corner of the screen. The icon will be displayed with a green check mark on it if the connection is successful.