



ELECTRIC PRESSURE COOKER

USER MANUAL

Model No.: GW22711 (6Qt), GW22712 (8Qt)



Please read through this manual carefully before use

 **IMPORTANT SAFEGUARDS AND TIPS**

WWW.GOWISEUSA.COM

THANK YOU FOR YOUR PURCHASE!

Join

the GoWISE Community on Facebook, Instagram, Twitter, and Pinterest for updates, tips, and great deals!



Explore

our recipes at www.gowiseproducts.com/blogs/recipes



Contact Our Customer Care Team

855-233-9199

support@gowiseusa.com

Live Chat at gowiseusa.com

M-F 8:30am - 4:00pm MST



Register Your Product

www.gowiseproducts.com/apps/product-registration

(Normally the serial number is on the bottom of the product. Please check there first.)



Specifications

Voltage: 120V, 60Hz

Watts: 6Qt - 1000W; 8Qt - 1300W

Working Pressure: 0-82.7kPa / 11.99PSI



TABLE OF CONTENTS

Register Your Product.....	2
Specifications.....	2
Important Safeguards.....	4
Parts and Accessories.....	6
Control and Features.....	8
Cooking Programs.....	10
General Operating Instructions.....	12
Before First Use.....	12
Getting Started.....	12
Safely Open the Lid After Cooking..	13
Safety and Cooking Tips.....	15
Pressure Canning.....	16
Using the Yogurt Preset.....	18
Care and Cleaning.....	19
Troubleshooting & Error Codes.....	20
Warranty.....	22

IMPORTANT SAFEGUARDS

HOUSEHOLD USE ONLY • READ ALL INSTRUCTIONS BEFORE USE

- 1.** This appliance cooks under pressure. Improper use may result in scalding injuries. Make certain the lid is properly closed before operating. **DO NOT** attempt to remove the lid while the cooker is operating.
CAUTION: To reduce the risk of electric shock, cook only in the included removable inner pot.
- 2. DO NOT** touch hot surfaces of the pressure cooker. **DO NOT** lift the pressure cooker by the lid handle. Use the side handles and pot holders when handling and lifting the pressure cooker.
- 3. DO NOT** place the pressure cooker on or near a hot gas or electric burner, or in a heated oven.
- 4.** This pressure cooker is intended for countertop use only. **ALWAYS** operate the appliance on a horizontal surface that is level, stable, and noncombustible.
- 5. DO NOT** use on newspaper, foam, or any other material that may block the vent at the bottom.
- 6. DO NOT** use below hanging cabinets to avoid damage from steam that is released from the regulator knob.
- 7. DO NOT** use the pressure cooker for anything other than its intended use. Not intended for outdoor use.
- 8. NEVER** deep fry or pressure fry in the cooker with oil.
- 9. ALWAYS** check the pressure valve and floater valve for clogging before use.
- 10. DO NOT IMMERSE** the cooker base in water. To protect against electric shock, **DO NOT IMMERSE** the cord, power plug, or cooker in any liquid.
- 11. DO NOT** operate cooker if the cord or plug is damaged, or after the cooker malfunctions, or has been damaged in any manner.
- 12. DO NOT** open the pressure cooker until it has cooled, and all internal pressure has been released. If the floater valve is still up or the lid is difficult to turn, it is an indication that the cooker is still pressurized – **DO NOT FORCE IT OPEN.**
- 13.** If you use the quick release method by using the pressure release switch, steam and liquids will be released through the pressure valve. **USE CAUTION** as the steam and liquids will be extremely hot.
- 14.** To avoid scalding from escaping steam while removing the lid, carefully lift the lid angled away from yourself.
- 15.** Unplug the appliance when not in use and before cleaning. **ALWAYS** allow the cooker to cool down before cleaning, putting on or taking off parts.
- 16. DO NOT OVERFILL** the inner pot. Certain foods, such as rice or vegetables may expand during

IMPORTANT SAFEGUARDS

HOUSEHOLD USE ONLY • READ ALL INSTRUCTIONS BEFORE USE

cooking. Overfilling may risk clogging the steam release and developing excess pressure. This may also cause leakage, personal injury, or damage to the cooker.

- 17. BE AWARE** that certain foods can foam, froth, sputter and clog the steam release. Some of these include applesauce, cranberries, pearl barley, oatmeal and other cereals, split peas, noodles, macaroni, rhubarb, and spaghetti. These foods should not be cooked under pressure cooking settings unless as directed in pressure cooker recipes.
- 18. MAKE SURE** the pressure release switch is in the Sealing position for all the pressure-cooking programs.
- 19. USE EXTREME CAUTION** when moving a pressure cooker containing hot liquids.
- 20.** This appliance should not be used by or near children or by individuals with disabilities or limited knowledge in using pressure cookers.
- 21.** Use of accessories and parts that are not recommended or supplied by the manufacturer may cause the cooker to malfunction or cause serious hazardous situations including personal injury. Other brands may not have the correct curvature to match the heating element.
- 22.** If the pressure cooker begins to malfunction during use,

immediately unplug the cord. **DO NOT USE OR ATTEMPT TO** repair a malfunctioning appliance!

- 23. CAUTION: HOT SURFACES.** This appliance generates heat, and steam may escape during use. Proper precautions must be taken to prevent the risk of personal injury, fires, and damage to property.
- 24. DO NOT USE** the **GoWISE USA Pressure Cooker** for any purpose other than described in this manual.
- 25. NEVER** operate the appliance unattended.
- 26.** If the **GoWISE USA Pressure Cooker** is used improperly, for professional or semi-professional purposes, or if it is not used according to the instructions in this user manual, the warranty becomes invalid, and the manufacturer will not be held liable for damages.

 **WARNING:** Spilled food can cause serious burns. Keep appliance and cord away from children. **NEVER DRAPE** cord over the edge of the counter, **NEVER USE** outlet below the counter, and **NEVER USE** an extension cord.

**SAVE THESE
INSTRUCTIONS**

PARTS AND ACCESSORIES

PARTS

1. Pressure Cooker Lid
2. Pressure Valve
3. Floater Valve
4. Pressure Release Switch
5. Lid Handle
6. Silicone Sealing Ring
7. Inner Lid
8. Stainless Steel Inner Pot
9. Carry Handle
10. Exterior Pot
11. LED Display
12. Control Panel
13. Heating Element
14. Power Cord

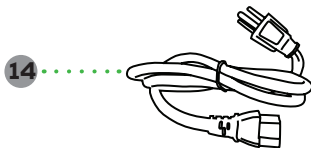
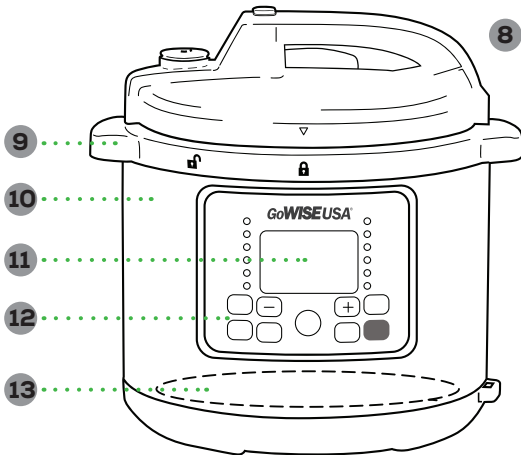
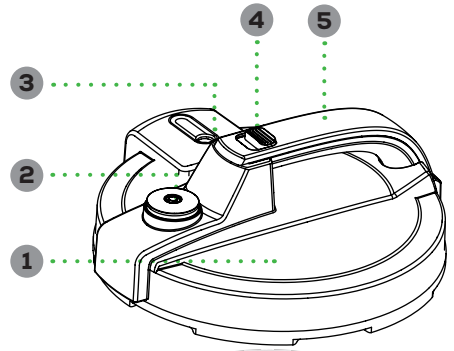

PARTS AND ACCESSORIES

ACCESSORIES

1. Steam Basket
2. Steam Rack
3. Rice Scooper
4. Measuring Cup

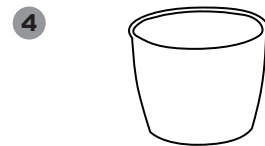
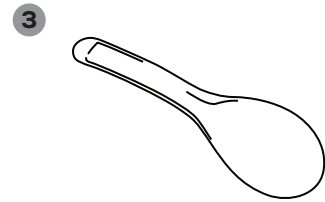
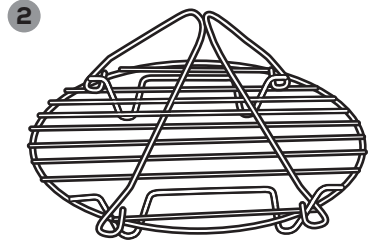
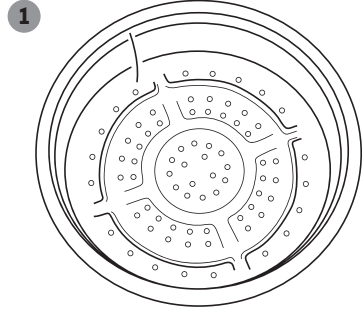

CONTROL AND FEATURES

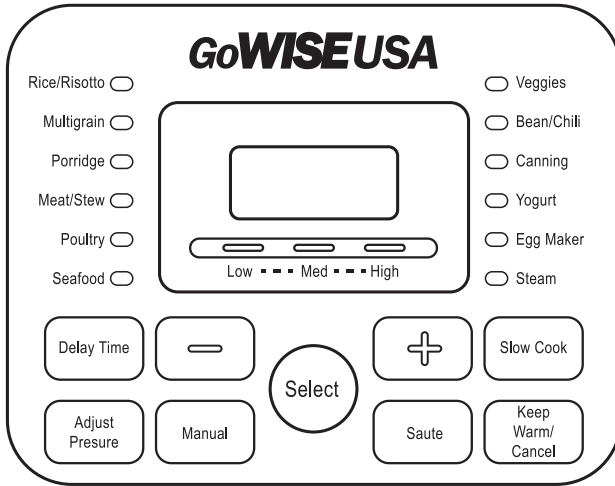

BUTTONS

SLOW COOK: Starts the Slow Cook function.

SAUTÉ: Starts the Sauté function.

SELECT: Cycles through the preset options.

KEEP WARM/CANCEL: Keeps food warm for up to 24 hours; stops the cooking process.

DELAY TIME: Delays the cooking process for up to 24 hours.*

ADJUST PRESSURE: Adjusts the pressure level between low, medium, and high.

MANUAL: Adjusts temperature and time of cooking presets or manual function.

+ & - buttons: Manually increase or decrease TEMP & TIME and Delay Time.

USING THE DISPLAY CONTROLS

1. Starting Up

When the cooker is plugged in, it will automatically go into standby mode. The LED display will show "----".

2. Program and Function Selection

Press Select button repeatedly to cycle through and select the desired cooking program. Press Sauté, Slow Cook, or Keep Warm/Cancel to select one of these functions.

3. Adjust Pressure

To adjust pressure settings, press the Adjust Pressure button to adjust pressure levels between low, medium, and high.

4. Adjust Time and Temperature

Press the Manual button to toggle between temp. and time settings. Use the "+" and "-" buttons to adjust.

CONTROL AND FEATURES

USING THE DISPLAY CONTROLS

NOTE: Each cooking program and function is set with a default time, temperature, and pressure level that may be adjustable. Refer to page 10 to see which settings are adjustable and not adjustable.

5. Slow Cook

Press the Slow Cook button and adjust the time in 30 minute increments from 1-20 hours using the "+" and "-" buttons. The screen will show "-- --" as the unit begins to heat. Once the temperature is reached (196°F), the display will count down from your selected time.

NOTE: The Slow Cook function does not cook with pressure. Therefore, the lid can be removed throughout the cooking cycle as needed to check food.

6. Sauté

Press the Sauté button and adjust the time in 1 minute increments between 1-20 minutes using the "+" and "-" buttons. The Sauté function will automatically start within 5 seconds and begin to heat. The display will read P0: [Your Selected Time] to indicate that there is zero pressure.

NOTE: Only use the Sauté function without the pressure cooker lid, and do not leave unattended.

7. Delay Time

Press the Delay Time button to set the delay timer for up to 24 hours. Adjust the time in 30-minute increments using the "+" and "-" buttons, or by continuing to press the Delay Time button until your preferred delay time is selected.

NOTE: DO NOT use the Delay Time with food items that will perish before your cooking cycle is set to begin.

8. Automatic Start

Once you have selected your desired cooking preset or function and adjusted as needed, simply step away. Your pressure cooker will automatically begin the cooking cycle after about 5 seconds unless the delay timer has been set.

9. Keep Warm/Cancel

For most presets, after your cooking cycle is complete, it will automatically switch to Keep Warm mode. Press the Keep Warm/Cancel button at any time to stop the cooking cycle.

NOTE: The cook time of Slow Cook and Sauté cannot be adjusted after the cooking cycle begins. Press the Keep Warm/Cancel button at any time to cancel.

COOKING PROGRAMS

Function /Preset	Default Time	Adjustable Time	Default Pressure	Adjustable Pressure Y/N
Sauté	20 min	1-30 min	//	N
Slow Cook	2 hr	1-20 hr	//	N
Keep Warm	//	//	//	N
Rice	8 min	5-25 min	High	Y
Multigrain	40 min	20-60 min	High	Y
Porridge	20 min	10-30 min	High	Y
Meat/Stew	35 min	10-45 min	High	Y
Poultry	15 min	5-30 min	High	Y
Seafood	8 min	1-15 min	High	Y
Veggies	5 min	2-10 min	High	Y
Bean/Chili	30 min	25-45 min	High	Y
Canning	45 min	10 min - 2 hr	High	N
Yogurt	8 hr	6-24 hr	//	N
Egg Maker	4 min	3-5 min	High	Y
Steam	8 min	1-20 min	High	Y

NOTE: When cooking rice, **DO NOT** exceed 10 cups of uncooked rice in the 6 Quart model or 14 cups of uncooked rice in the 8 Quart model. Exceeding these recommendations may cause rice to be under cooked.

COOKING PROGRAMS

Function /Preset	Pressure Range (PSI)			Temperature (°F)		
	Low	Medium	High	Low	Medium	High
Sauté	//	//	//	356°F (+/- 37.4°F)		
Slow Cook	//	//	//	196°F (+/- 37.4°F)		
Manual	6.96	7.97-8.70	11.99	231.8°F	234.5°F	240.8°F
Rice	6.96	7.97-8.70	9.28-10.15	231.8°F	234.5°F	238.5°F
Multigrain	6.96	7.97-8.70	11.99	231.8°F	234.5°F	240.8°F
Porridge	6.96	7.97-8.70	11.99	231.8°F	234.5°F	240.8°F
Meat/Stew	6.96	7.97-8.70	11.99	231.8°F	234.5°F	240.8°F
Poultry	6.96	7.97-8.70	11.99	231.8°F	234.5°F	240.8°F
Seafood	6.96	7.97-8.70	11.99	231.8°F	234.5°F	240.8°F
Veggies	6.96	7.97-8.70	9.28-10.15	231.8°F	234.5°F	238.5°F
Bean/Chili	6.96	7.97-8.70	11.99	231.8°F	234.5°F	240.8°F
Canning	//	//	11.99	//	//	240.8°F
Yogurt	//	//	//	100-108°F (+/- 37.4°F)		
Egg Maker	6.96	7.97-8.70	9.28-10.15	231.8°F	234.5°F	238.5°F
Steam	6.96	7.97-8.70	11.99	231.8°F	234.5°F	240.8°F

GENERAL OPERATING INSTRUCTIONS

BEFORE FIRST USE

1. Please pay attention to the warnings and safeguards in this manual to avoid any injury or property damage.
2. Unbox the Unit and place on a countertop or flat surface away from any water source and near a polarized outlet. Before plugging in the Unit, remove accessories from the Inner Pot. Unwrap accessories. Locate the power cord before throwing away packaging materials.
3. Wash the inner pot, lid, silicone sealing ring, and accessories with soapy water. Rinse with warm water and dry thoroughly.

NOTES:

- We recommend doing an initial test run with water to learn the controls and how the cooker operates before cooking your first meal. Follow steps 1-4 in "GETTING STARTED" (pg. 12-13) and use at least 3 cups of water.
- During the initial cooking cycle, it is normal for air to release from the floater valve for 10-20 seconds. After the cold air is expelled, the remaining interior air temperature increases and the floater valve will close.

GETTING STARTED

1. To open lid, grasp the lid handle and turn clockwise until the arrow aligns with the Unlocked icon, and lift upward.

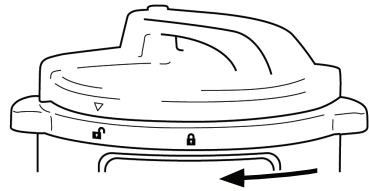

2. Remove the inner pot and place cooking ingredients inside. Monitor the level of the water and ingredients per cooking instructions to ensure they do not exceed 2/3 of the inner pot height.
NOTE: Rice, beans, or other ingredients that will expand during cooking should not be filled beyond 1/2 of the inner pot height.
3. Clean and towel dry the external surface of the inner pot and place it inside the cooker, rotating it slightly to ensure proper contact with the heating element. Make sure there is no material between the inner pot and the exterior pot before you insert it into the cooker.
4. To close the lid, place lid on the pressure cooker and turn the handle counter-clockwise so the arrow aligns with the Locked icon.
CAUTION: Make sure the lid is closed and properly aligned before pressure cooking. If the lid is not closed properly, the cooker will not start.

GENERAL OPERATING INSTRUCTIONS

GETTING STARTED

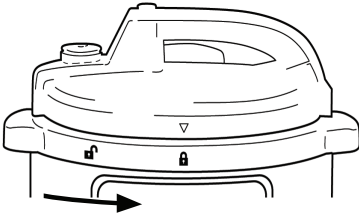

5. Set the time and temperature by using one of the cooking presets or the Manual setting. Adjust the cooking time by pressing the “+” and “-” buttons. Adjust the cooking pressure between Low, Med, and High by pressing the Adjust Pressure button.

NOTE: Refer to page 9 “USING THE DISPLAY CONTROLS”.

6. The cooker will automatically start after 5 seconds and “- - - -” will display and flash until the selected pressure level and temperature are reached. The display will then begin counting down from the set cooking time.

7. After the cooking cycle is complete, the cooker will beep and enter “Keep Warm” mode while the cooker is naturally releasing pressure.
NOTE: To prevent over-cooking, press the “Keep Warm/Cancel” button to turn off the “Keep Warm” mode.

HOW TO SAFELY OPEN THE LID

If pressure cooking, **ALWAYS** make sure that all the pressure in the cooker has been released before attempting to open the lid.

The pressure can be released manually by using the Pressure Release Switch, or naturally by letting the cooker to cool down.

Release pressure in one of the following ways:

1. Quick Release:

Slide the Pressure Release Switch to the “Venting” position to let out steam until the floater valve drops down.

SEALING

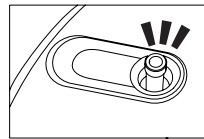
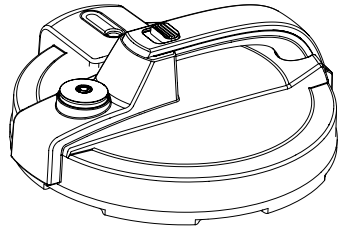

FLOATER VALVE UP

(continued on next page)

GENERAL OPERATING INSTRUCTIONS

HOW TO SAFELY OPEN THE LID

VENTING

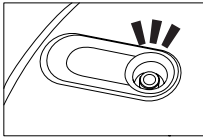
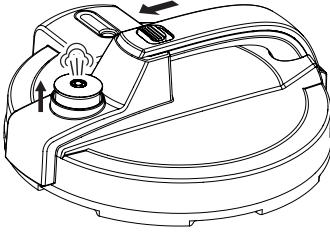

FLOATER
VALVE DOWN

CAUTION: Please keep hands and face away from the top of the pressure valve when using **Quick Release**. The escaping steam is very hot and can cause scalding.

CAUTION:

- During the pressure release process, protect your skin by avoiding any contact with escaping steam and **DO NOT** touch the stainless-steel portion of the Lid. Press down gently on lid and turn it clockwise until the lid meets resistance. Lift carefully and set aside. Avoid personal injury resulting from hot unit surfaces and dripping liquids.
- **DO NOT** open the lid until pressure inside the pot is completely released. As a safety mechanism, the lid is locked and cannot be opened until the floater valve drops. **DO NOT ATTEMPT TO FORCE OPEN THE LID.**

2. Natural Release:

Allow the cooker to cool down naturally until the floater valve drops down. This process can take up to 40 minutes or longer depending on the amount of food in the cooker. Place a wet towel on the lid to speed up cooling. After the cooling has finished, turn off Keep Warm mode if it is turned on.

NOTE: It is recommended to use **Natural Release** for foods with a large liquid volume or starch content, such as porridge, congee, etc. Thick liquids may splatter out if the Quick Release method is used.

SAFETY AND COOKING TIPS

- **EXTREME CAUTION** should be taken when sliding the pressure release switch to the **Venting** position. Keep hands and face away from the pressure valve openings. Failure to comply may result in scalding or serious injury.
- **DO NOT** open the lid until pressure inside the cooker is completely released. As a safety mechanism, the lid will remain locked and cannot be opened until the floater valve drops.
- When opening the lid, the inner pot may stick to the lid. This is caused by vacuum due to cooling. To release the vacuum, slide the pressure release switch to the Venting position.
- If the floater valve is stuck, slide the pressure release switch to the Venting position. If all the steam has released, push the floater valve down with a pen or long stick.
- **ALWAYS** add at least 1 cup of water or other liquids so enough steam can be generated to cook under pressure. These include cooking sauces, wine, beer, stocks, juices of fruit and vegetables. Oils and oil-based sauces do not have enough water content and will not account for the required liquid volume.
- When cooking rice, **DO NOT** exceed 10 cups of uncooked rice in the 6 Quart model or 14 cups of uncooked rice in the 8 Quart model. Exceeding these recommendations may cause rice to be under cooked.
- The time to build pressure and cook will vary according to the temperature and quantity of the ingredients. Food that is cold or frozen will take longer to cook than food that is at room temperature.
- The Delay Timer is not recommended for porridge, oatmeal or other foamy and thick liquids. Cooking progress should be monitored when cooking these foods.

PRESSURE CANNING

Canning allows you to preserve fresh and cooked vegetables, fruits, meats, jellies, and jam. It is very important that you read this guide and follow all steps carefully to ensure that the food has been processed properly and is safe for consumption.

Experimenting with cooking times, ingredients, and temperatures is very dangerous and risky when it comes to canning. Be sure that you are using the exact time, temperature, and method specified in the canning recipe. This will help protect the food from harmful bacteria, molds, and enzymes. In addition, too much time will destroy the nutrients and flavor.

Food enzymes that promote the growth of molds and yeasts (causing food to spoil), can be destroyed by reaching a temperature of 212°F with steam canning methods. However, other contaminants such as salmonella, staphylococcus aureus, and clostridium botulinum (cause of botulism) may develop. A temperature of 240°F must be reached to kill these harmful bacteria.

NOTE: Improper canning can lead to serious health consequences. The temperature at which water can boil varies depending on sea level. The GoWISE USA pressure cooker will operate up to a maximum altitude of 2,000 ft. above sea level. **DO NOT USE THIS UNIT FOR PRESSURE CANNING ABOVE AN ALTITUDE OF 2,000 FT.**

HOW TO CAN

1. Prepare and mix ingredients as instructed in your recipe.
2. Fill an 16-oz. clean canning jar to the level shown in Figure 1. **DO NOT** exceed the level shown, as there needs to be at least 1-inch of headspace at the top.

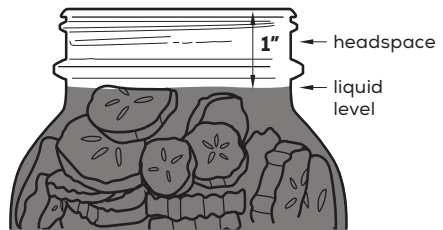

Figure 1.

3. Gently tap the sides of the jar to remove any trapped air bubbles. Or, press a spoon between food and jar to remove the bubbles as shown in Figure 2.



Figure 2.

PRESSURE CANNING

HOW TO CAN

4. Install a clean lid on top of the jar and then add a screw band to tighten in place. (Figure 3.)

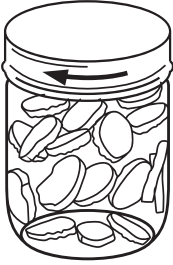

Figure 3.

5. Place the inner pot inside the pressure cooker, and the rack inside the pot.
6. Place filled, sealed jars onto the rack. **DO NOT OVERFILL.** Make sure the jars are not touching each other.
7. Pour hot water over the jars into the insert pot until the water level is about $\frac{1}{4}$ of the way up the sides of the jars.
8. Place and lock the pressure cooker lid on top. Select the Canning preset and make adjustments for your canning recipe.
9. Once the cooking process has completed, it will automatically switch to Keep Warm mode. Slide the Pressure Release Switch to the "Venting" position to release the pressure.
10. Once all the pressure is released, carefully remove the pressure cooker lid.

11. Remove the hot jars using canning tongs and place them on a heat-resistant surface. Allow the jars to cool to room temperature.

CAUTION: Be careful when removing the jars from the inner pot. Always use heat resistant gloves or tongs, as the jars will be very hot.

12. Once the jars are cool, remove the screw bands. The lids should be tightly sealed to the jars. There should not be a springing or popping sound when pressing the middle of the lid. If there is, **DO NOT STORE** this food for future use. It must be reprocessed immediately or refrigerated and used within a few days.

NOTE: DO NOT retighten lids after processing the jars. The contents contract as jars cool, pulling the self-sealing lid firmly against the jar to form a high vacuum. If screw bands are too tight, liquid will escape from jars during the process and it will not seal. Over tightening the lids will also cause damage to the lid and jar. They should only be removed after jars have cooled.

⚠ CAUTION: The GoWISE USA pressure cooker will not effectively operate as a pressure canner at an altitude of 2,000 ft. above sea level.

USING THE YOGURT PRESET

HOW TO MAKE YOGURT IN A PRESSURE COOKER

Prior to using the Yogurt preset (which maintains the correct temperature for creating yogurt), you must boil the milk using the Steam or Sauté function first.

If making your yogurt in jars, it is best to use the Steam function to begin.

1. Place the inner pot into the cooker and place the rack into the pot.
2. Fill mason jars with milk and place them onto the rack inside the pot (without lids). Add ½ cup of water to the pot and close the pressure cooker lid.
3. Select the Steam preset and adjust the pressure to low. Adjust the time to 1 minute. The pressure cooker will start automatically after 10 seconds.
4. Once the pressure cooker beeps, use the pressure release switch to release any remaining pressure before opening the lid. Carefully remove the mason jars from the cooker and place onto a heat resistant surface. Allow milk to cool down to 115°F (use an external thermometer).
NOTE: Use tongs or oven mitts to remove the mason jars, as the jars and contents will be very hot.
5. Once the milk has cooled down, add your yogurt or yogurt starter to the milk and stir until there are no chunks.

6. Place the jars back into the cooker and close the lid.
7. Select the Yogurt preset and select a cook time between 6–24 hours. The longer you set it for, the tangier your yogurt will be.
8. When finished, use tongs to remove the mason jars, add the lids and store for later! For Greek yogurt, strain the yogurt prior to storing.

If making your yogurt in one large batch, it is best to use the Sauté function to begin.

1. Place the inner pot into the cooker and place the rack into the pot.
2. Pour ½ gallon of milk into the pot.
3. Select the Sauté function, and gently stir the milk as it heats up. Sauté the milk until it reaches a temperature of at least 180°F. Turn off the sauté function and allow the milk to cool to 115°F.
4. Once the milk has cooled down, add your yogurt or yogurt starter to the milk and stir until there are no chunks.
5. Close the pressure cooker lid and select the Yogurt preset. Choose a cook time between 6–24 hours. The longer you set it for, the tangier your yogurt will be.
6. When finished, place yogurt in a container for storing. For Greek yogurt, strain the yogurt prior to storing.

CARE AND CLEANING

⚠ CAUTION: ALWAYS remove the pressure valve and pin to clean the opening and remove any blockage that might have occurred during the cooking process. **THIS MUST BE DONE AFTER EACH USE.**

DO NOT attempt to repair the Pressure Valve yourself. Contact Customer Care at 855-233-9199 for more information.

Cleaning:

- Remove the lid and gently wipe down with a damp, soapy cloth, gently rinse with clear water and wipe dry with a soft cloth.
- Clean the silicone sealing ring and inner lid after each use by removing them from the pressure cooker lid and washing them separately with warm, soapy water, rinsing them with clear water and wiping it dry with a soft cloth.

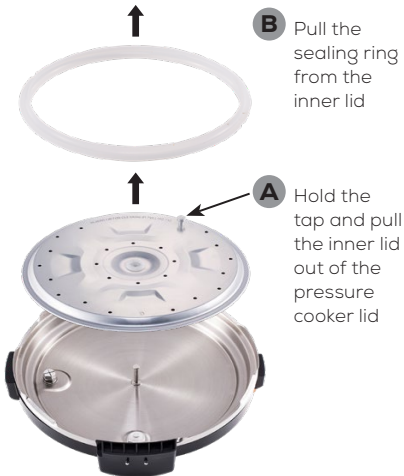

- Remove the inner pot and wash with warm, soapy water. Rinse with clear water and wipe dry with a soft cloth.
NOTE: The inner pot is dishwasher safe.
- Wipe the inner cooker base rim and blot dry with cloth to prevent rusting of the exterior cooking rim.
- Clean the outer body with a damp, soft cloth or sponge.
- **NEVER** use harsh chemical detergents, scouring pads or powders on any of the parts or components.
- **NEVER** immerse the outer housing and power cord in water or any other liquid.

After Cleaning:

- Be sure to properly position the silicone sealing ring and inner lid back on the pressure cooker lid.
- Check the pressure and floater valve to ensure that they are working properly and free of debris.

TROUBLESHOOTING & ERROR CODES

Problem	Possible Cause	Solution
Difficulty with closing the lid	Silicone sealing ring is not properly installed	Remove and reposition the sealing ring properly.
	Floater valve is in the popped-up position	Slightly press the floater valve downward.
Difficulty with opening the lid	Pressure is not fully released from the pressure cooker	Slide the pressure release switch to the Venting position to reduce internal pressure. Open the lid after the pressure is completely released.
	Floater valve is stuck in the popped-up position	Press the floater valve lightly with a pen or long utensil.
Steam leaks from the rim of the lid	No silicone sealing ring	Install the silicone sealing ring.
	Food debris attached to the silicone sealing ring	Clean the silicone sealing ring.
	Silicone sealing ring damaged	Replace the silicone sealing ring (contact Customer Care Team).
	Lid not closed properly	Open and then close the lid again.
Steam leaks from the floater valve	Food debris on the floater valve and silicone ring	Clean the floater valve and silicone ring.
	Floater valve and silicone ring worn out	Replace the floater valve and silicone ring (contact Customer Care Team).
Floater valve unable to rise	Too little food or water in the inner pot	Add water according to the recipe.
	Floater valve obstructed by the lid locking pin	Close the lid completely, see "General Operation Instructions" section (pg. 13).
Steam comes out from the pressure valve non-stop	Pressure valve not in the Sealing position	Slide the pressure release switch to the Sealing position.
	Pressure controls fail	Contact Customer Care Team
Rice is half cooked or too hard	Too little water	Adjust dry rice and water ratio according to the recipe.
	Lid opened too early	After cooking cycle completes, leave the lid on for 5 more minutes.
Rice is too soft	Too much water	Adjust dry rice and water ratio according to the recipe. In a pressure cooker this is often a 1:1 ratio (vs. 2:1 like a standard rice cooker)

TROUBLESHOOTING & ERROR CODES

Problem	Possible Cause	Solution
Display remains blank after connecting the power cord	Bad power connection or no power	Inspect the power cord to ensure a good connection check if power outlet is active.
	Cooker's electrical fuse has blown	Contact Customer Care Team
ERROR CODES		
Displays "E01"	Temperature sensor disconnected	Contact Customer Care Team
Displays "E02"	Temperature sensor has short circuit	Contact Customer Care Team
Displays "E03" as soon as power cord is plugged in	Overheating, power board is burned	Contact Customer Care Team
Displays "E03" in the middle of cooking process	Food burned or stuck on the bottom of the inner pot	Clean the sticky or burned food off the inner pot. NOTE: Do not scrub too hard as it may damage the pot.
Displays "E04" as soon as power cord is plugged in	Loose connection of the exterior power cord	Plug in the exterior power cord again to ensure both connections with the cooker and with the outlet are tight.
	Loose connection of the interior red wire	Contact Customer Care Team
	The pressure switch is disconnected	Contact Customer Care Team
Displays "E04" after pressure cooking starts	Signal switch has loose connection	Contact Customer Care Team

Customer Care Team

855-233-9199

support@gowiseusa.com

Live Chat at gowiseusa.com

M-F 8:30am - 4:00pm MST

WARRANTY

GoWISE USA warrants all products against defects in materials and workmanship for **one (1) year** effective from the date of purchase.

GoWISE USA will replace any products that are found to be defective due to manufacturer flaws based on eligibility. Refunds issued by GoWISE USA must be purchased directly from GoWISE USA and are only available to the original purchaser within the first 30 days. We do not issue refunds for items bought by thirdparty retailers.

This warranty extends only to personal use and does not extend to products that has been used for commercial, rental or any other use this product was not intended for. There are no warranties other than the warranties expressly set forth with each product.

This warranty is non-transferrable. GoWISE USA is not responsible in any way for any damages, losses, or inconveniences caused by equipment failure by user negligence, abuse, or use noncompliant with the user manual or any additional safety, use, or warnings included in the product packaging and manual.

This warranty only covers purchases within the 48 contiguous States of United States of America. For purchases made outside the 48 contiguous states, such as, AK, HI, PR or Canada; upon receipt of a proven defect by video or picture, we will replace the unit under the 1-year warranty, however the replacement will only ship to a freight forwarder or an address within the 48 contiguous United States. The consumer is responsible for arranging shipment outside of the 48 contiguous states.

GoWISE USA assumes no liability for damage caused using this product other than for its intended use or as instructed in the user manual. Some states do not allow this exclusion or limitation of incidental or consequential losses, so the foregoing disclaimer may not apply to you. This warranty gives you specific legal rights and you may also have other rights which may vary from state to state.

ALL EXPRESSED AND IMPLIED WARRANTIES INCLUDING THE WARRANTY OF MERCHANTABILITY, ARE LIMITED TO THE PERIOD OF THE LIMITED WARRANTY.

NOTE: General Warranty excludes refurbished / auction items.

WARRANTY

Additional 60-Days Warranty

You can extend your 1-year warranty by an additional 60 days. Log onto [www.gowiseproducts.com/apps/ product-registration](http://www.gowiseproducts.com/apps/product-registration) and register your product within the first 14 days of your purchase for the extended warranty.

DEFECTIVE PRODUCTS & RETURNS

If your product is defective within the 1-year warranty period, please email our Customer Care Team at support@gowiseusa.com. To expedite your issue, please provide at least 3 of the 4 items below:

1. Copy of the invoice, order information, or gift receipt showing the date of purchase
2. Serial number, usually found on a sticker located on the bottom on back of the unit
3. Picture or video of the issue or defect that you are experiencing
4. Shipping address information

Authorized Retailers:

Amazon

GoWISE USA

WayFair

Houzz

Home Depot

etailz

MorningSave.com

Bed Bath & Beyond

Jet.com

Walmart.com

Macy's

GoWISEUSA®

WWW.GOWISEUSA.COM

855-233-9199

support@gowiseusa.com

Live Chat at gowiseusa.com

M-F 8:30am - 4:00pm MST

- To ensure the correct use of this appliance, read these instructions carefully and thoroughly.
- Please keep this manual for future reference.
- Thank you for purchasing this GoWISE USA Pressure Cooker.

USE PROMO CODE: **LIVewiseraF**

10% OFF

YOUR NEXT **GoWISEUSA®** PURCHASE

