

GoWISE USA®

Instruction Manual

8-in-1 Electric Pressure Cooker
GW22620 - 6 QT. | GW22623 - 8 QT.



WWW.GOWISEPRODUCTS.COM

Table of Contents

Product Introduction	3
Important Safeguards	4
Product Structure & Features	6
Before First Use	8
Pressure Cooker Settings	9
How to Use your Pressure Cooker	11
Delay Timer	12
Slow Cooking	13
Saute	14
Steam	15
Yogurt	16
Egg Maker	17
Cleaning	18
Troubleshooting	19
Warranty	21

Product Introduction

The GoWISE USA GW22620/GW22623 8-in-1 Electric Pressure Cooker is a new model of programmable pressure cooker. It is an 8-in-1 multi-function cooker: pressure cooker, rice cooker, yogurt maker, food warmer, steamer, saute, slow cooker, and egg maker. It features 12 cooking option presets: Rice, multi-grain, Porridge, Steam, Soup, Meat/Stew, Bean/Chili, Saute, Poultry, Yogurt, Slow Cook, and Egg Maker. With this pressure cooker, you can set the pressure time manually, and switch between low and high pressure, as well as temperature settings for the slow cook function. It also features a delay timer and a pressure reading display to show how much pressure is being used for the duration of the cooking time. It also comes with a stainless steel steam rack, rice scooper, and measuring cup.

Important Safeguards

1. READ THE MANUAL.
2. This appliance cooks under pressure; please do not attempt to remove the lid while the cooker is operating. Improper use may result in burn or injury.
3. Do not touch hot surfaces. Always use the handles.
4. Do not overfill the cooking pot because food such as rice or vegetables may expand during cooking. Overfilling the cooker may result in developing more pressure or clogging the vent pipe.
5. Be aware that certain foods, such as applesauce, cranberries, pearl barley, oatmeal or other cereals, split peas, noodles, macaroni, rhubarb, or spaghetti can froth, and sputter, and clog the pressure release device (steam vent).
6. DO NOT use your pressure cooker for deep frying.
7. Always check the pressure release vent for clogs before use.
8. DO NOT immerse the cord, plug, or cooker in water or any other liquids to avoid electrical shock or damaging the cooker.
9. Keep cooking unit out of children's reach.
10. Unplug the appliance when not in use and before cleaning. Wait until cooker and parts are cooled down to a safe temperature before removing or replacing any cooker parts.
11. Do not operate this appliance with a damaged cord or plug. If your cooker experiences any malfunctions or has been damaged in any way, don't attempt to use it.
12. DO NOT use outdoors.
13. DO NOT use below hanging cabinets to avoid damage from steam that is released from the regulator knob.
14. Use of any accessories that are not intended for this product may damage the unit and is subject to voiding warranty.
15. DO NOT place the cooker on an unstable surface. DO NOT use on newspaper, foam, or any other material that may block the vent at the bottom.

(continued on next page)

Important Safeguards (continued)

16. DO NOT operate or place your pressure cooker on a stove top.

NOTE: A short power-supply cord is provided to prevent the risks of becoming entangled in or tripping over a longer cord.

If a separate power supply cord is purchased, IT MUST BE USED PROPERLY.

THE MARKED ELECTRICAL RATING OF THE EXTENSION CORD MUST BE AT LEAST AS GREAT AS THE ELECTRICAL RATING OF THE APPLIANCE.

MODEL	POWER SUPPLY	RATED POWER	VOLUME
GW22620	120V, 60Hz	1000W	6 QT

Product Structure & Features

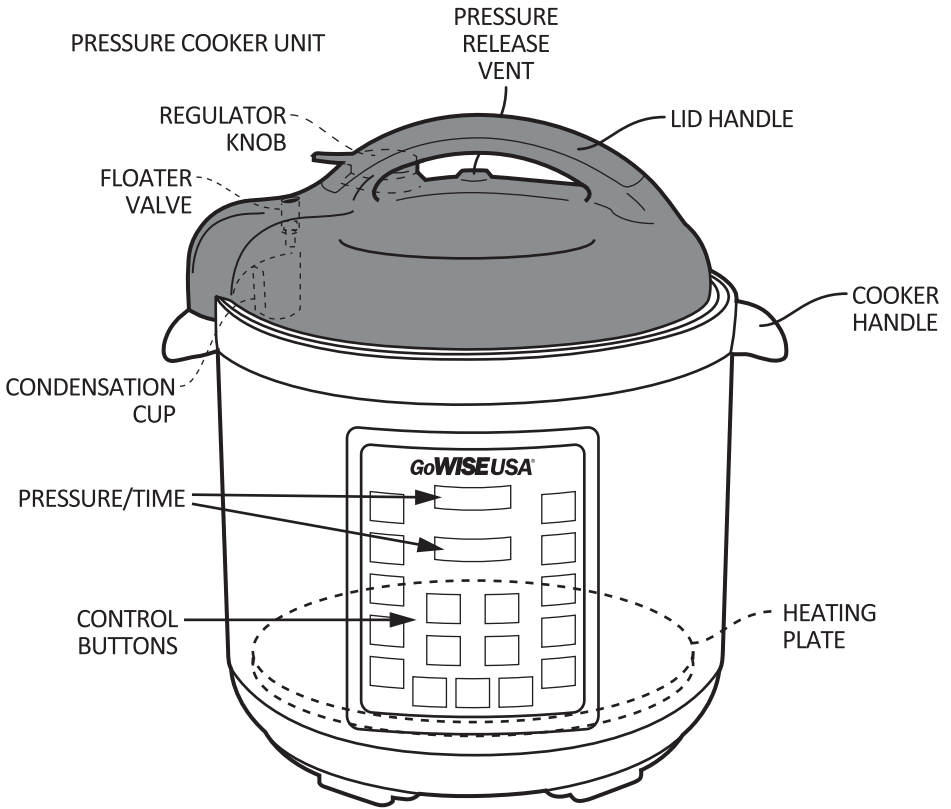

COOKER LID
(UNDER SIDE)

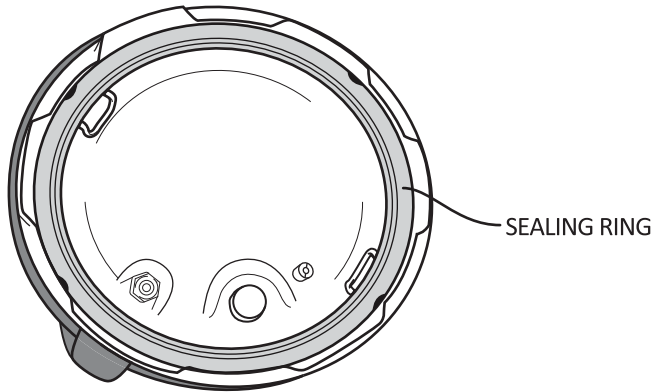

(continued on next page)

Product Structure & Features (continued)

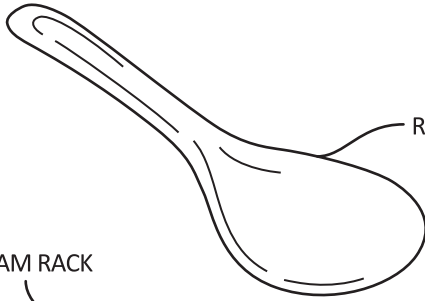

RICE SPOON

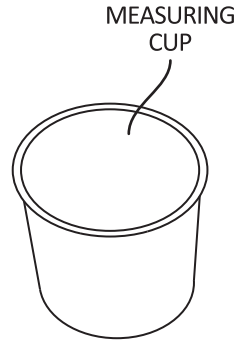

MEASURING CUP

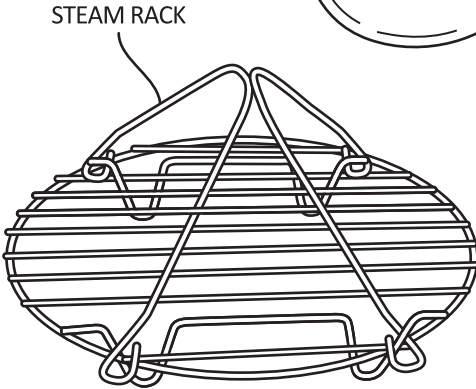

STEAM RACK

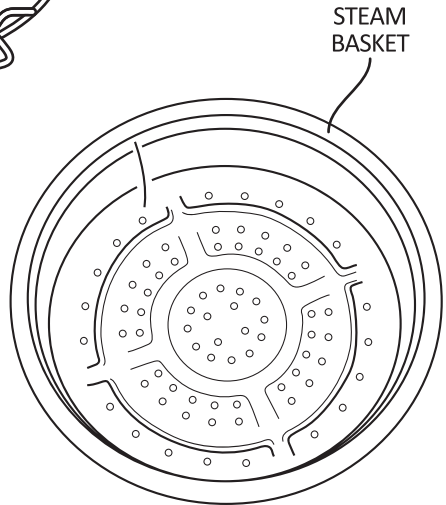

STEAM BASKET

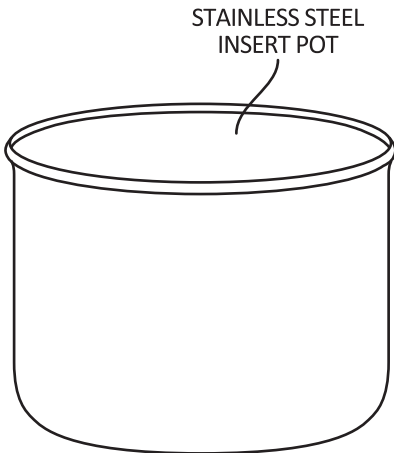

STAINLESS STEEL INSERT POT

Before First Use

1. Remove all packaging materials, stickers, and labels.
2. Be sure to remove cooking pot and check that all parts are included.

Before you use your GoWISE USA electric pressure cooker for the first time, wipe the cooker clean with a damp cloth. Clean the lid and the cooking pot. The cooking pot can be cleaned with warm soapy water. Do not put the cooking pot in the dishwasher. Rinse with clean water, towel dry or air dry, and once completely dry, insert into pressure cooker.

The sealing ring may already be installed on the lid, if not, make sure that the sealing ring is installed properly on the lid as shown below:

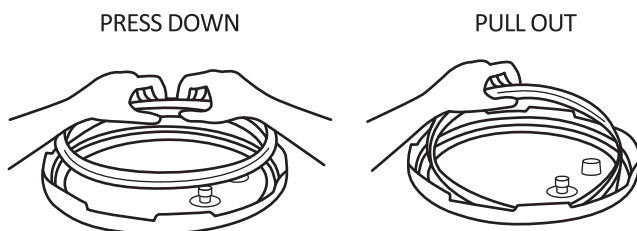

NOTE: You can take out the sealing ring after cooking your meals to clean it. You can clean the sealing ring with warm soapy water. Make sure to dry it before inserting it back into the lid.

Pressure Cooker Settings



There are 12 cooking presets, with preset time and pressure values. You can adjust the cooking time with the Pressure Time +/- . You can also adjust the pressure level and temperature (depending on the cooking option) by pressing the "Adjust" button. This pressure cooker comes with the following cooking options and times:

- Rice: 5, 8, 10 Mins.
- Multi-grain: 20, 40 Mins., 1 hour
- Porridge: 15, 20, 30 Mins.
- Meat/Stew: 20, 35, 45 Mins.
- Poultry: 5, 15, 30 Mins.
- Egg Maker: 1, 3, 5 Mins.
- Steam: 1, 3, 5 Mins.
- Bean/Chili: 25, 30, 45 Mins.
- Yogurt: 8, 24 hours
- Soup: 20, 30, 40 Mins.
- Saute: 30 Mins.
- Slow Cook: up to 20 hours

(continued on next page)

Pressure Cooker Settings

After you have set a time, you can press Adjust to change between Low, or High pressure. Low pressure is a range from 2.9 - 7.2 psi and High pressure is a range from 7.2 - 13 psi.

NOTE: The cooking option "Sauté" does not use pressure and does not require the lid, but must be supervised in order to prevent it from burning or being overcooked.

COOKING TEMPERATURES

Pressure LOW: 2.8 PSI - 7.2 PSI

Pressure HIGH: 7.2 PSI - 13 PSI

Sauté LOW: 206.60 °F to 210.20 °F

Sauté MED: 257.00 °F to 293.00 °F

Sauté HIGH: 312.80 °F to 320.00 °F

Slow cook LOW: 176.00 °F to 179.60 °F

Slow cook MED: 179.60 °F to 190.40 °F

Slow cook HIGH: 190.40 °F to 210.20 °F

*For the Yogurt program, the unit will heat up to 181.40 °F, will boil for 5 minutes, then it stops and cools down naturally. It will beep 10 times as reminder when it finishes boiling and beep 10 times again when temperature drops down to 114.80 °F, at which the display reads "Yogt". Press "Adjust" to select desired temperature and "+" "-" button to set the cooking time.

How to Use your Pressure Cooker

1. To remove the lid, grasp the top handles, turn clockwise, and lift.
(when the lid handle is aligned with the cooker handle, it is closed;
when the lid handle is aligned with the condensation cup, it is open.
2. Insert your ingredients into the stainless steel insert pot. (NOTE: Do not fill more than 60% capacity of the pot. For food that expands, such as dried vegetables and beans, you must not exceed 50% capacity of the pot. When cooking with pressure, **YOU MUST ALWAYS USE AT LEAST 1/2 CUP OF WATER.**
3. Seal the lid and set the regulator knob to pressure. To place the lid and lock securely, place the lid on to the cooker so the lid handle is in line with the condensation cup. Then, turn clounterclockwise so the cooker lid locks. During this motion, the small pin on the side of the lid will go in and out, indicating a secure lock.
4. The regulator knob has two dots labeled "Steam" and "Pressure". You can use these two dots as guidelines for positions the knob.
5. Plug the pressure cooker into the wall outlet. The two LED displays will display horizontal lines. You can use of the preset cooking options or set the cooking time yourself. You can set the time manually by pressing or holding "Pressure Time+" until your desired time is selected. Once you have set your pressure time, press adjust to select High or Low pressure for cooking.
6. Once you have prepared your cook settings, the cooker will start to heat up after 4 seconds and automatically start cooking once it reaches pressure. The timer does not start until there is enough heat and pressure within the range of the chosen pressure level.

(continued on next page)

How to Use your Pressure Cooker (continued)

7. During the cooking process, it is normal for the cooker to be silent. If the cooker is noisy and releasing a lot of steam, carefully adjust the knob in either direction until the steam and noise reduces
(KEEP FACE AND OTHER OBJECTS CLEAR OF THE PRESSURE RELEASE VENT AS HOT STEAM WILL BE RELEASED).
8. When the cooker has completed the cooking cycle, **DO NOT REMOVE THE LID YET.** Before removing the lid, any pressure inside the cooker must first be released. You can either wait until all the pressure naturally releases or you can release the pressure quickly by turning the regulator knob to steam **(KEEP FACE AND OTHER OBJECTS CLEAR OF THE PRESSURE RELEASE VENT.)** When the pressure has been released, you may open the lid.

Delay Timer

This setting allows you to begin cooking food up to 24 hours later. You can use this setting with any of the cooking options provided.

NOTE: Perishable foods such as meats, poultry, fish, cheese, and dairy products cannot be left at room temperature for more than two hours, and no longer than one hour when the temperature of the room is above 90°F. Be sure to set the delay timer to no more than 2 hours, in this case.

To set the Delay Timer:

1. Remove the cooking pot and fill it with foods and liquids then put the cooking pot back into the cooker.
2. Choose a cooking option and set the time.
3. Once you have set the cooking time, immediately press the “delay timer” button repeatedly until you reach the desired time. The time will show on the bottom display in half-hour increments.

NOTE: YOU MUST PRESS THE DELAY TIMER BUTTON IMMEDIATELY AFTER YOU HAVE SET A COOKING TIME, OR THE COOKER WILL AUTOMATICALLY START COOKING AFTER IT HAS WARMED UP.

Slow Cooking

1. Insert your ingredients into the pot and close the lid. Set the regulator knob to "Steam".
2. Press the "Slow Cook" button and 30 minutes will appear on the timer display. To add more time, immediately press the "Pressure Time +" button repeatedly. It will add more time in half hour increments. You can slow cook up to 20 hours.
3. Once you have set a time, immediately press the "Adjust" button to set the temperature to either of the 3 levels: "Low", "Mid", and "High". The cooker will automatically start after 4 seconds. The "Heating" light will be on.
4. It will take at least 5 minutes for the cooker to reach the set temperature. Please note that the timer will not start counting down until the cooker has reached the set temperature.
5. When slow cooking is done, it will beep and automatically go into warming mode.
6. When slow cooking is done, it will beep and automatically go into warming mode.

Slow cook LOW: 176.00 °F to 179.60 °F

Slow cook MED: 179.60 °F to 190.40 °F

Slow cook HIGH: 190.40 °F to 210.20 °F

Sauté

1. Insert your ingredients into the pot and leave the lid off of the pressure cooker.
2. Press "Sauté" and leave the lid off. If you would like to set a temperature, immediately press "Adjust" repeatedly to choose "low", "mid", or "high". Cooking will start after 4 seconds. The cooking time for Sauté is 30 minutes. You can always press the "Warm/Cancel" button to stop the cooking process.

NOTE: Do not leave the pressure cooker unattended while Sautéing.

Sauté LOW: 206.60 °F to 210.20 °F

Sauté MED: 257.00 °F to 293.00 °F

Sauté HIGH: 312.80 °F to 320.00 °F

Steam

This cooking option is for cooking starchy vegetables such as corn, potatoes, yams, etc. It is not recommended for non-starchy vegetables such as broccoli, asparagus, and tomatoes.

1. Remove the cooking pot and fill it with liquid, no higher than the steam rack.
2. Place the steam rack on the bottom of the cooking pot. You may also place the steam basket on top of the rack, if you'd like.
3. Add ingredients to the cooking pot and lock the lid in place.
4. If you'd like to use the timer while steaming, turn the regulator knob to "pressure". If you'd like to steam indefinitely, turn the knob to "steam".
5. Press the "Steam" button repeatedly to choose 1, 3, and 5 minutes. You may also manually set the time by pressing the "pressure time +/-" buttons. You may also manually set the time by pressing the "pressure time +/-" buttons.
6. When steaming is finished, the cooker will beep and automatically go into warming mode. If you turned the regulator knob to "pressure", release the pressure by turning the knob to "steam". You can also wait for the pressure to naturally release slowly. When the pressure has been released, you may open the lid.

NOTE: When using the steam rack, be sure to use pot holders to remove either the pot or rack because it will be hot after cooking.

Yogurt

When making yogurt:

1. Pour milk into the insert pot and close the lid.
2. Press "Yogurt", and then immediately press "Adjust" until you see the word "Boil" on one of the LED screens.
3. Turn the regulator knob to "Pressure", then press the "Steam" button until the preset time is set to one minute.
4. Once the pressure cooker is done steaming the milk, carefully remove the pot from the cooker and wait for the milk to cool down to 115°F (use an external thermometer).
5. Once the milk has cooled down, add your yogurt or yogurt starter to the milk and stir until there are no chunks.
6. Place the pot back into the cooker and close the lid.
7. Set the knob to "Steam" and press the "Yogurt" button. Immediately press "Adjust" to change the time to either 8 hours or 24 hours.

When cooking milk in Jars:

1. Fill the jars with milk, place rack into the pot, and place milk jars onto the rack inside the pot.
2. Add 1/2 cup of water into the pot and close the lid.
3. Turn the regulator knob to "Pressure", then press on the button labeled "STEAM" until the preset time is set to one minute.
4. Once the pressure cooker is done steaming the milk, carefully remove the pot from the cooker and wait for the milk to cool down to 115°F.
5. Once the milk has cooled down, add your yogurt or yogurt starter to the milk and stir until there are no chunks.
6. Place the jars back onto the rack inside the pot and close the lid.
7. Set the knob to "STEAM" and press the "Yogurt" button. Quickly press Adjust to change the time to either 8 hours or 24 hours.

NOTE: When using the steam rack, be sure to use pot holders to remove either the pot or rack because it will be hot after cooking.

Egg Maker

1. Remove cooking pot and insert steam rack and basket that are provided.
2. Add 1/2 cup of water to the pot.
3. Put the cooking pot back into the cooker and close the lid.
4. Turn the knob to "Pressure" and press the "Egg Maker" button. A preset time of 1, 3, or 5 minutes will come up. Use the guidelines below to determine the amount of time and pressure level to use for different types of eggs. Quickly press "eggmaker" repeatedly until the desired time is displayed. Your unit will start cooking after 4 seconds. The cooker will beep then go into warming mode when done. Turn the regulator knob to steam and release the pressure before you open the lid.

Egg Making Times

Soft Boiled:	1 minute (Low Pressure)
Medium Boiled:	2 minutes (Low Pressure)
Hard Boiled:	5 minutes (Low Pressure) or 2 minutes (High Pressure)

Cleaning

Pressure Cooker Unit, Lid and Pot

1. Always unplug the cooker and allow it to cool to a safe temperature before beginning any cleaning.
2. Use a dry or damp soft cloth to wipe the cooking unit and lid. DO NOT IMMERSE OR SPRAY THE COOKER UNIT OR LID WITH ANY LIQUID.
3. Remove the condensation cup by pulling it down. Clean it with warm, soapy water. Rinse and dry it thoroughly. Put the condensation cup back by snapping it up into place.
4. Clean the stainless steel insert pot with warm soapy water and a non-abrasive, soft sponge.

Regulator knob cleaning instructions

1. Pull off the regulator knob to clean it.
2. Clean any tiny crevices on the knob.
3. Replace the regulator knob by firmly pushing it down into place.

Sealing ring cleaning instructions

1. Remove the sealing ring and clean with warm soapy water. Be sure to dry the sealing ring before placing it back into the lid.

Troubleshooting

Problem	Reason	Solution
Difficulty closing the lid	The seal gasket is not well placed. Floater valve is stuck. Too Hot.	Place the seal gasket in the proper position. Check valve hole and push anything blocking floater. Wait until unit cools.
Difficulty opening the lid	Floater valve does not drop after pressure release.	Take off regulator knob to release steam until the floater valve drops, then turn the lid to open it.
Steam leaking around the lid	Seal gasket is not placed. Food remains in the seal gasket. Damaged seal gasket. The lid is not well placed.	Place the seal gasket. Clean the seal gasket. Replace the seal gasket. Cover the lid according to the directions (pg. 11).
Steam leaking around floater valve	Food remains in the floater valve. The seal gasket of the floater valve is worn out.	Remove the seal gasket of the floater valve, clean and replace. Replace the seal gasket of the floater valve.

Error Codes

- E1 The pressure cooker has an abnormal sensor. For E1, please contact our customer service department for further instruction.
- E2 The pressure cooker's sensor is not working properly. For E2, please contact our customer service department for further instruction.

(continued on next page)

Troubleshooting (continued)

Error Codes

- E3 The pressure cooker overheated. Unplug the cooker, remove the cooking pot with pot holders(The pot will be hot) and wait for the cooker to cool down(wait at least 30 minutes to an hour before cooking). Try adding more water if there is not enough water before trying to cook again, and check for steam.
- E4 The pressure switch cut off before the cooker reached temperature. Unplug the cooker for at least 30 seconds to 1 minute to reset and plug it back in. If problem persists, contact our customer service department for further help.

Warranty

General Warranty (Excluding Refurbished/Auction Items)

GoWISE USA has a 1-year limited warranty for all products. Products are warranted against defects in materials and workmanship for 1-year from the date of purchase, when used in accordance with the instructions provided. This warranty does not cover damages or wear resulting from accident, misuse, abuse, commercial use, or unauthorized adjustment and/or repair.

For all GoWISE USA Pressure Cookers / Smoker, the removable lid and all components (float valve, regulator knob, sealing ring, steam basket, stainless-steel rack, insert pot) are warranted for 30 days from the day of purchase and DO NOT fall under the 1-year limited warranty of the unit.

For all GoWISE USA Air Fryers, the removable basket, tray, and all components are warranted for 30 days from the day of purchase and DO NOT fall under the 1-year limited warranty of the unit.

GoWISE USA® shall not be liable for loss of use or any other incidental, consequential or indirect costs, expenses or damages. There are no express warranties except as listed above. This warranty gives you specific legal rights, and you may have other rights which vary from state to state.

CALL: 1-855-233-9199 for RETURN INSTRUCTIONS.

WE DO NOT SERVICE PRODUCTS OUTSIDE THE 48 CONTINENTAL UNITED STATES. (WE WILL SHIP TO A FREIGHT FORWARDER FOR CUSTOMERS)

NOTE: Customers are responsible for all return shipping costs. When item(s) are returned under warranty as being defective, they are thoroughly tested to verify manufacturer defect. If any item(s) are determined to be in proper working order after testing, all shipping costs to have the product returned to the customer will be the responsibility of the customer.

Return Period: 30 Days

All return requests must be made within 30 days from the date our customers purchase their product(s). Refunds are only applicable during the

Warranty(continued)

30-day return period and may be subject to restocking fees up to 15% of the original purchase amount. If the product is defective within 30 days, GoWISE USA will cover the cost of return shipping, however, a picture and/or video is required to receive a prepaid label. If the product is missing any accessories that were included in the original shipment or the product is damaged, altered, or used, the item may no longer be eligible for a refund or replacement. Any decision of refund and/or replacement will be decided at the discretion of GoWISE USA.

NOTE: Customers are responsible for all return shipping costs after 30 days.

Defective / Freight Damaged:

Products that are within the 30-day return period and have been determined by customer service to be defective are qualified for a return label for the product to be returned to GoWISE USA for inspection and testing. GoWISE USA will provide a return shipping label for defective product(s) only. Customers must contact the Carrier (shipping company) for products that have arrived damaged after initial transit. Clear photographic AND video proof of damage and/or defective products is REQUIRED prior to GoWISE USA authorizing the return of any product.

Regarding Purchase From 3rd Parties

In order for the GoWISE USA customer service team to look up the warranty information regarding the product(s), the original order information and/or proof of purchase is required. Without this information GoWISE USA will be unable to move forward with providing a replacement under warranty, as we do not know the date or origin of the purchase. GoWISE USA does not have a working business relationship with 3rd party selling sites or services or individuals which are not listed below as one of our Authorized Retailers. GoWISE USA is not responsible for making inquiries to such 3rd parties for the purpose of obtaining documentation. It is the responsibility of the person(s) making the warranty claim to provide original documentation such as order information and/or a receipt so that customer service can process your request. Any claim made under GoWISE USA warranty guidelines must be made by original purchaser of the product(s). Any defective product will be replaced as long as the issues with the device fall within warranty guidelines.

GoWISEUSA®

www.gowiseproducts.com

support@gowiseusa.com

1-855-233-9199

8:30AM - 4PM (AZ Time)

- To ensure correct use of this appliance, read these instructions carefully and thoroughly
- Please keep this manual for future reference.
- Thank you for purchasing this GoWISE USA Pressure Cooker.