

24" DEEP DIRECT DRAW KEG REFRIGERATORS



EBD – Series

- EBDS2-24 • EBD2-24
- EBD3-24 • EBD4-24



EBDS2-24



EBD2-24



EBD3-24



EBD4-24

Cabinet Construction

Heavy duty stainless steel countertop with textured and laminated black vinyl exterior. Galvanized steel interior wall, and high quality stainless steel floor. 1 3/4" thick high density foamed-in-place polyurethane insulation. Built-in caster thread receptacles for all units.

Refrigeration System

- Side mounted condensing unit
- Oversized condenser and evaporator coils quickly achieve and maintain desired temperature
- Forced-air cooling with oversized evaporator fan motors providing balanced airflow throughout cabinet to ensure faster temperature drop
- Removable side panel and slide-out condensing unit for convenient repair and maintenance
- Environmentally friendly CFC free R-134A refrigerant
- Air defrost controlled by electrical timer
- Copper tube and aluminum fin evaporator with anti-corrosive coating
- Energy efficient condensate drain pan assembly heated by high side copper tube
- Pre-wired and ready to plug, 115V/60Hz/1Ph, NEMA 5-15P

Doors

- Textured and laminated black exterior with galvanized steel interior
- 1 3/4" thick high density foamed-in-place polyurethane insulation
- One piece snap-in magnetic door gaskets for easy replacement
- Heavy duty recessed door handles for a flat surface
- Door locks

Draft Arms

- NSF approved 3" diameter insulated stainless steel draft arm with air distributor
- Two draft arms

Lighting

- Shielded incandescent interior lighting with on/off switch

Temperature Control

- Factory preset temperature, 35°F
- Temperature setting range from 32°F to 42°F
- Easy to set analog thermostat

Options

- 2 1/2" and 4" diameter casters (3 1/2" and 5" overall height)
- Dual faucet towers

- Project / Customer _____
- Item No. _____
- Model No. _____



Warranty

5 Year — Compressor Warranty
3 Year — Parts & Labor Warranty
 Applicable to units purchased after July 1, 2014.

Contact

201 W. Artesia Blvd, Compton, CA 90220
 T. (310) 323-6586, (800) 444-6285
 F. (310) 323-7524, (310) 761-1127

24" DEEP DIRECT DRAW KEG REFRIGERATORS



EBD – Series

- EBDS2-24 • EBD2-24
- EBD3-24 • EBD4-24

Dimensions

SIDE VIEW

★ 3/4" O.D.



T-Shaped PVC
Drain Fittings w/
Moveable Plug

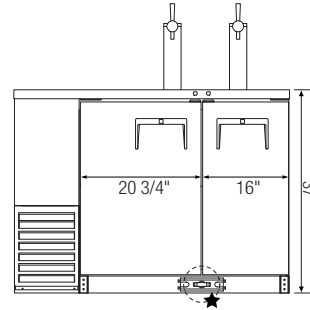
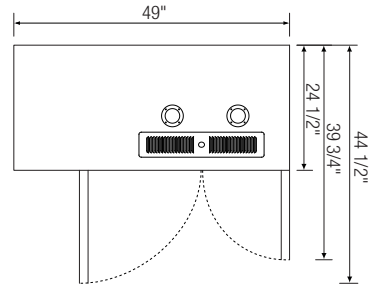
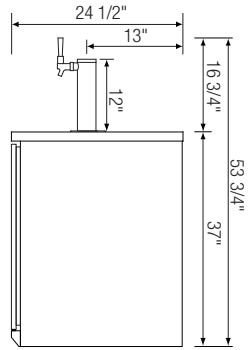

▲ EBDS2-24

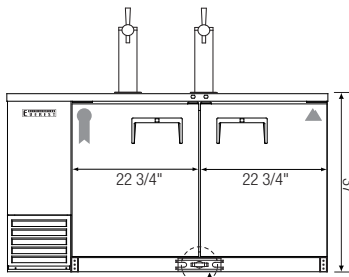
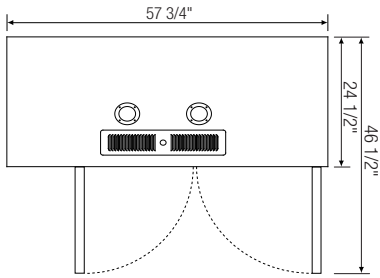

▲ EBD2-24

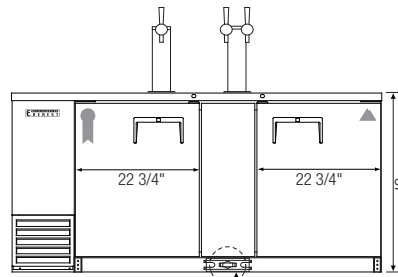
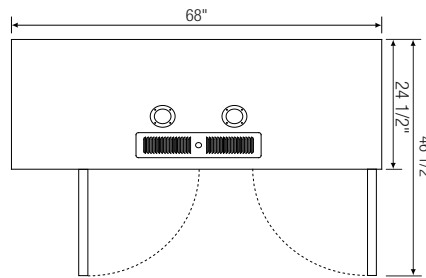

▲ EBD3-24

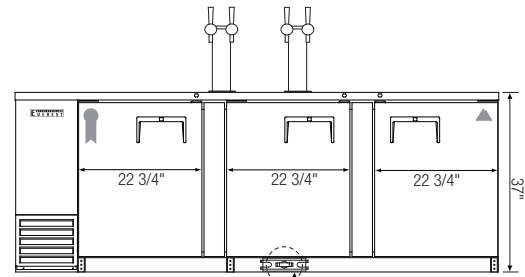
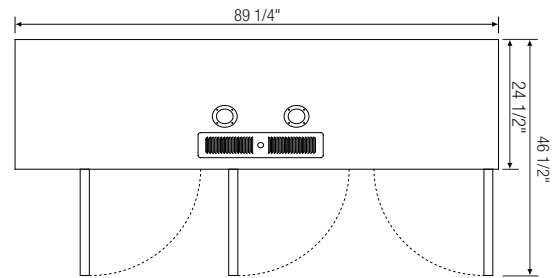

▲ EBD4-24

Model	Ref/ Frz/ Dual	# of Doors	Capacity & Size of Barrels	Capacity (Cu.Ft.)	HP	Refrigerant	Power (V-Hz-Ph)	Amps	Crated Weight (LBS)	Exterior Dimensions (Inches)			* Height does not include towers Ref = Refrigerator Frz = Freezer Dual = Ref & Frz Combo
										L	D	H*	
EBDS2-24	Ref	2	(1) 1/2 (1) 1/4 - slim	13.95	1/4	R-134A	115-60-1	4.20	250	49	24 1/2	37	
EBD2-24	Ref	2	(2) 1/2	16.86	1/4	R-134A	115-60-1	4.20	280	57 3/4	24 1/2	37	
EBD3-24	Ref	2	(3) 1/2	20.41	1/4	R-134A	115-60-1	4.20	297	68	24 1/2	37	
EBD4-24	Ref	3	(4) 1/2	27.76	1/3	R-134A	115-60-1	4.50	380	89 1/4	24 1/2	37	

Disclaimer: Product dimensions are for general purposes and not absolute value. Slight variations may exist. If dimensions are critical, please contact Everest.