



SIDE MOUNT UNDERCOUNTER FREEZERS

Side Mounted Condensing Unit

ET – Series

• ETF1 • ETF2 • ETWF2 • ETF3

Cabinet Construction

Heavy duty stainless interior and exterior and galvanized steel finished top, bottom and back wall of exterior. High quality 16 gauge stainless steel worktop. ABS evaporator drain cover. Insulated with 2.5" thick high density foamed-in-place polyurethanes insulation. Four 4" diameter casters (front casters with brakes). Door heater installed around inside cabinet frame to prevent moisture build-up.

Refrigeration System

- Side mounted condensing unit for extra interior space compared to back mounted units
- Oversized condenser and evaporator coil cools to set and maintain temperature in minimum time period
- Forced-air cooling with oversized evaporator fan motors providing balanced airflow throughout cabinet to ensure faster temperature drop
- Removable side panel and slide-out condensing unit for convenient repair and maintenance
- Removable condenser coil air filter for easy cleaning
- Environmentally friendly CFC free R-134A and R-404A refrigerant
- Adjustable, time initiated defrost cycle of 3 to 12 hours with 350 watt heater, both time and temperature terminated for fail-safe backup
- Copper tube and aluminum fin evaporator with anti-corrosive coating
- Energy efficient condensate drain pan assembly heated by high side copper tube
- Pressure relief port located at exterior back wall for rapid re-entry
- Pre-wired and ready to plug, 115V/60Hz/1Ph, NEMA 5-15P



ETF1



ETF2



ETWF2



ETF3

Doors

- Heavy duty stainless steel interior and exterior
- 2.5" thick foamed-in-place polyurethane insulation
- Rounded corners for a sleek and modern appearance
- Heavy duty adjustable torsion spring self-closing door system
- One piece snap-in magnetic door gasket for easy replacement
- Heavy duty recessed door handles for a flat surface

Lighting

- Safety shielded incandescent interior lighting

Shelving

- Two epoxy coated wire shelves per section
- 304 stainless steel pilasters and shelf clips

Temperature Control

- Factory preset temperature, -4°F
- Temperature setting range from -10°F to 32°F
- Easy to read digital temperature display
- Easy to program push button temperature control
- Microchip digital monitoring system with a variety of functions to monitor and maintain optimum temperature

Option

- Stainless steel backsplash for worktop use

• **Project / Customer** _____
 • **Item No.** _____
 • **Model No.** _____

Warranty

2 Year — Parts & Labor
 5 Year — Compressor



Please visit our website for updated Energy Efficiency information

201 W. Artesia Blvd, Compton, CA 90220
 T. (310) 323-6586, (800) 444-6285 F. (310) 323-7524

www.EVERESTref.com

SIDE MOUNT UNDERCOUNTER FREEZERS

Side Mounted Condensing Unit



ET – Series

• ETF1 • ETF2 • ETWF2 • ETF3

Dimensions

SIDE VIEW

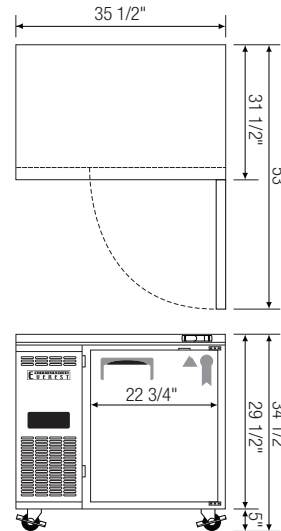
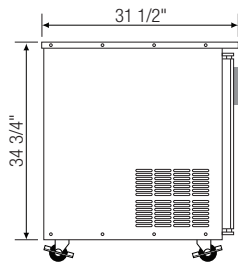

▲ ETF1

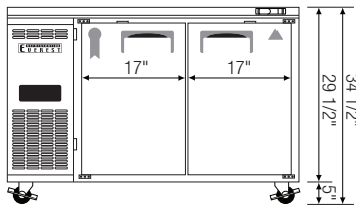
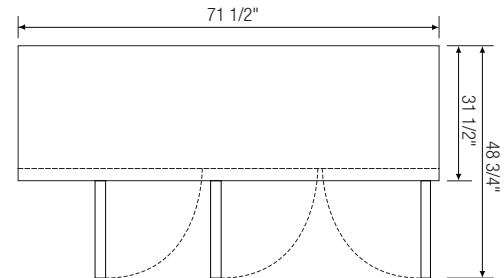
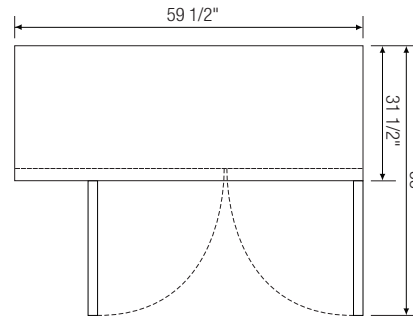
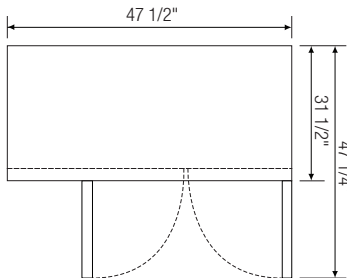

▲ ETF2

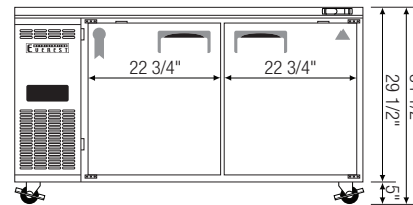

▲ ETWF2

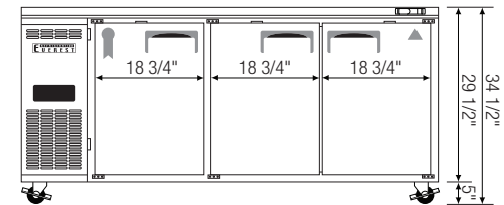

▲ ETF3

| Model | Ref/ Fzr/ Dual | # of Doors | Capacity (Cu.Ft.) | HP | Refrigerant | # of Shelves | Power (V-Hz-Ph) | Amps | Crated Weight (LBS) | Exterior Dimensions (Inches) | | | * Height does not include 5" for castor. Ref = Refrigerator Fzr = Freezer Dual = Ref & Fzr Combo |
|-------|----------------------|---------------|----------------------|-----|-------------|-----------------|--------------------|------|---------------------------|---------------------------------|--------|--------|---|
| | | | | | | | | | | L | D | H * | |
| ETF1 | Fzr | 1 | 9 | 1/3 | R-134A | 2 | 115-60-1 | 4.41 | 231 | 35 1/2 | 31 1/2 | 29 1/2 | |
| ETF2 | Fzr | 2 | 13 | 1/2 | R-404A | 4 | 115-60-1 | 7.50 | 273 | 47 1/2 | 31 1/2 | 29 1/2 | |
| ETWF2 | Fzr | 2 | 18 | 1/2 | R-404A | 4 | 115-60-1 | 7.50 | 304 | 59 1/2 | 31 1/2 | 29 1/2 | |
| ETF3 | Fzr | 3 | 22 | 1/2 | R-404A | 6 | 115-60-1 | 7.67 | 380 | 71 1/2 | 31 1/2 | 29 1/2 | |

Specifications subject to change without notice.

www.EVERESTref.com

201 W. Artesia Blvd, Compton, CA 90220
T. (310) 323-6586, (800) 444-6285 F. (310) 323-7524