



EVEREST REFRIGERATION

Commercial Refrigerators & Freezers

Owner's Manual for models

- Solid Door Upright Reach-Ins:
ESR1, ESRH2, ESR2, ESWR2, ESR3, ESF1, ESFH2, ESF2, ESWF2, ESF3, ESRF2, ESWRF2, ESWQ3, ESRF3
- Door & Drawer Combo Upright Reach-Ins:
ESR1D2, ESR2D2, ESR2D4, ESRF2D2, ESWQ2D2
- Glass Door Upright Reach-ins:
ESGR1, ESGR2, ESGWR2, ESGR3

A Step Above the Standard



Thank you for selecting an EVEREST product.

www.EVERESTref.com



A Step Above the Standard

967 Sandhill Ave., Carson, CA 90746
Tel : 310-323-6586, 800-444-6285
Fax : 310-323-7524

Visit our website at www.EVERESTref.com

WARNING - When using your appliance, always follow basic precautions, including the following :

When installing the unit, be careful that the electrical cord is not under the unit or pressed against the wall. This could cause damage to the cord.

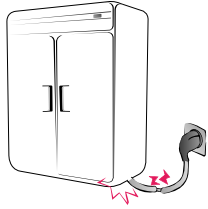

Before starting the unit for the first time, make sure the unit is free from all packaging. Packaging left on the unit during operation may cause a fire hazard.

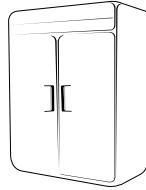

To prevent electrical shock, please do not plug or unplug the cord with wet hands.

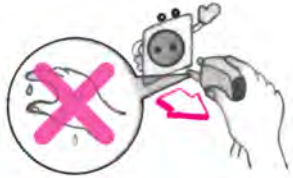

Before cleaning or maintaining the unit, please unplug it. Do not use any flammable cleaning products on or around the unit.

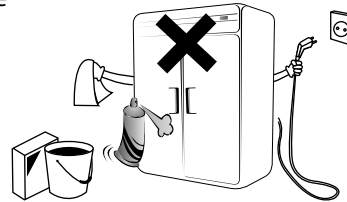

Install the unit on a hard and level surface.

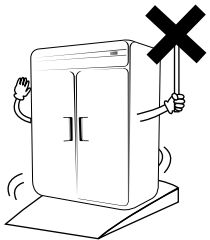

Please do not hang or climb on the unit as this may cause the unit to fall.



Please do not store temperature sensitive items in the unit, such as medical or science research related materials.

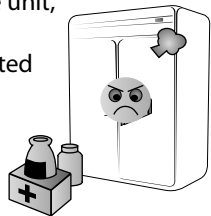

If you suspect a refrigerant leak, unplug the unit and immediately contact an authorized service technician.



WARNING - Read and follow all safety notices in this installation guide. These notices provide helpful safety and efficient operation information. Failure to do so may lead to serious injury and / or damage to the unit.

To minimize shock and fire hazards, be sure not to overload the outlet into which the unit is plugged into. A dedicated circuit of sufficient amperage is preferred.

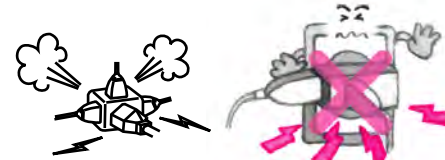

To prevent electrical shock and malfunction, do not spray the unit with water.

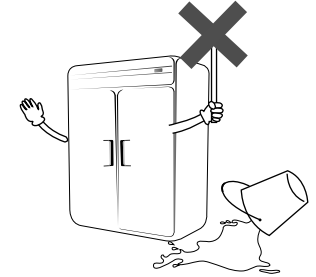

Clean the prongs of the electrical plug with a soft cloth or brush before plugging it into an electrical receptacle to prevent a fire hazard.



When it is time to salvage the unit, make sure to remove the rubber gaskets from the doors to prevent the risk of children or animals getting trapped inside the unit.

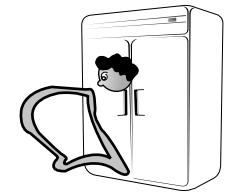

Do not place or store any objects on top of the product during operation. It might cause severe damage to the product. The machine room is located on top and disclosed for a ventilation purpose.

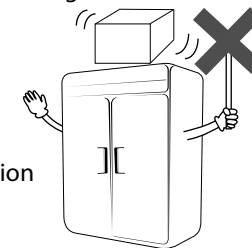

To prevent electrical shock and damage to the electrical cord, please hold the plug head when plugging and unplugging the unit.



Do not use the electrical cord or plug if they are damaged in any way.



Do not put your hands under the unit when moving it. You could be injured by sharp edges, protruding parts, crushing, etc.



Avoid installing the unit where it could be exposed to water or moisture.

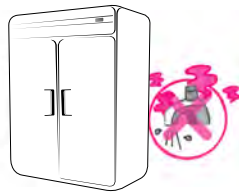

After unplugging the unit, please wait at least 6 minutes before re-plugging it in. Failure to do so could cause extensive damage to the compressor.

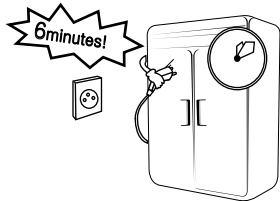

Avoid touching frozen foods or containers, especially metal containers, with wet hands. It could cause frostbite.



If the unit will not be used for an extended period of time, please unplug it from the outlet.



Please do not attempt to remove or repair any components unless you are an authorized service technician.

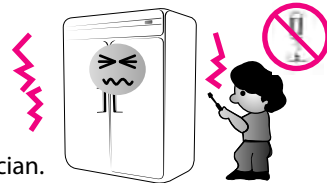

The refrigerator compartment's temperature should be set from 34°~54°F, and -4 to 32°F for the freezer. Setting the temperature out of the recommended ranges will void the unit's warranty.

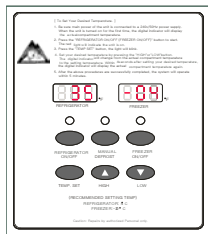

Keep the doors closed properly at all times. Check periodically if the door gaskets seal perfectly. Losing cold air from the cabinet due to old gaskets will lead to severe damage to the product and increased electrical consumption.

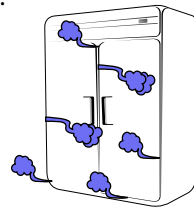

Install the unit on a hard and level surface or the unit could produce undesired noises.

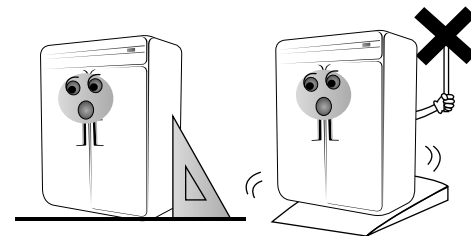

The unit should be positioned at least 7" away from the wall for proper ventilation.

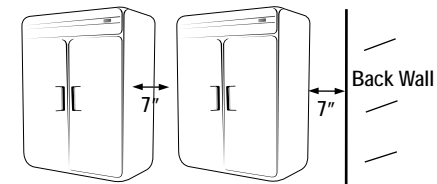

Indoor Use Only

Outdoor use may cause a decrease in performance and significant damage to the unit.

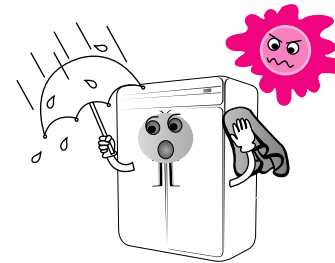

Dusty and High Humidity Areas

Dusty environments will cause the condenser coil to prematurely clog which will require it to be cleaned more often.

High humidity environments could cause the unit to rust.

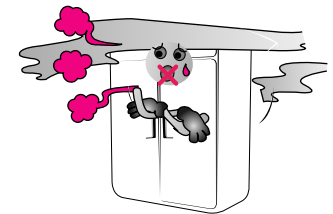

Do not build an enclosure or cabinet around the unit.

Restricting the airflow around the unit's condenser area will cause the compressor to work harder, which can result in compressor failure and the unit not being able to maintain the desired temperature.

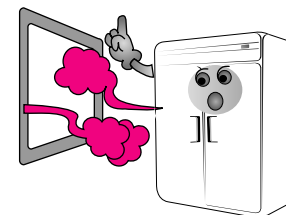

Select a location away from other heat and moisture generating equipment such as stoves, ovens, dish washers, etc.

High ambient temperatures cause the compressor to work harder, which can result in compressor failure and the unit not being able to maintain the desired temperature.

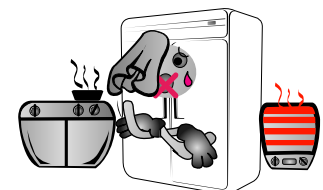

Shelf Cleaning

Periodically remove the shelves from the unit and clean them with mild soap and warm water.

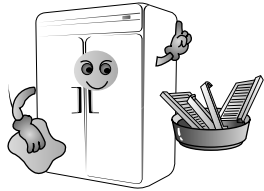

Door Gasket Cleaning

To preserve the life span of the door gasket, clean the gasket with mild soap and water on a regular basis.



Do not use the following products when cleaning

Clean the exterior of the product with a stainless steel cleaner only. Never use steel wool, strong acids, abrasive cleaners or degreasers. Acidic products and products containing vinegar must be stored in sealed containers to prevent acid damage to the interior of the unit and the evaporator coil. (Rust resulting from the lack of or improper maintenance will not be covered under warranty.)

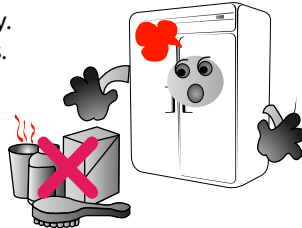

Interior Cleaning

Clean the interior surface of the unit with mild soap and warm water. Do not let water accumulate inside the unit. To prevent water damage, wipe the interior of the unit with a dry cloth as needed. Do not use abrasive cleaners, concentrated detergents, bleaches, cleaning waxes, solvents or polishes to clean the interior of the unit.

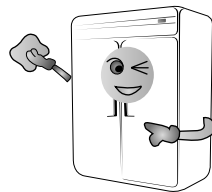

Condenser Coil Cleaning

Poor condensing unit performance is caused by heavy dust build-up on the condenser coil. The condenser coil should be cleaned monthly. Shine a flashlight through the condenser coil to check for dirt between the fins. Clean the outside of the condenser with a soft brush or a vacuum with a brush attachment. The condenser coil should be cleaned in the direction of the fins, top to bottom, not side to side. Be careful not to bend the fins. Detailed instructions of this procedure can be found on page 13 in this manual.

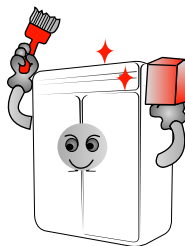

1. The front top grill (A) must be opened before reversing the door. Grab it from either side of its bottom edge and pull it towards you and tilt it up until it locks into place.
2. Remove the 6 screws (B) which are located in the pre-drilled holes used to mount the door hinges on the left door pillar (when facing the unit). 3 screws are for the top hinge and 3 screws are for the bottom hinge.
3. Note the location of the door switch tab (F) and remove it. Once the door is reversed, the tab must be installed in the same location in relation to the unit so that it can press in the door switch when the door is closed.
4. Before the door can be removed, the tension stored in the top and bottom of the doors' self closing springs must be safely released. To release the tension in the springs, insert a rigid object into one of the door spring shaft's unoccupied tension lock screw holes (C-1, D-1). Gently turn the door spring shaft until you can easily unscrew the tension lock screw (C-2, D-2). Remove the tension lock screw. Slowly remove the rigid object which was inserted into one of the spring shaft's unoccupied tension lock screw holes. When the rigid object clears the hole, the door spring will release the stored tension and the door spring shaft will spin violently. Remember that there are two springs, the top and the bottom, whose tensions must be released.
5. Have a second person secure and hold the door (E) against the unit while the top hinge is removed.
6. Remove the top hinge (C) by removing the 3 screws securing it.
7. Remove the door by lifting it until the bottom clears the bottom hinge (D). Ensure that the top and bottom springs and springs' shafts do not fall out.
8. Remove the bottom hinge (D) by removing the 3 screws securing it.
9. The right top hinge becomes the left bottom hinge (C). Install the right top hinge into the left bottom position using 3 screws. Ensure that the door hinge pins are facing up.
10. Flip the door (E) over so that the hinged part is on the left side, when facing the door.
11. Install the door onto the bottom door hinge (C). The longer of the two pins pointing upward should be inserted into the bottom spring shaft.
12. Have a second person secure and hold the door (E) against the unit while the top hinge is installed.
13. The bottom right hinge becomes the left top hinge (D). Install the left top hinge onto the door. The two pins on the door hinge should be facing down and the longer of the two inserted into the top door spring shaft.
14. Secure the top hinge to the unit using 3 screws.
15. The door should now be secured to the unit. Ensure that the door is secured before proceeding.
16. Tension must be added to the doors' springs for the self closing action to work. Using two rigid objects that can be inserted into the door springs' unoccupied door spring shaft tension lock screw holes (C-1, D-1), turn the shaft counterclockwise, when viewing the shaft from a birds eye perspective. 2 to 3 rotations of tension should be added.

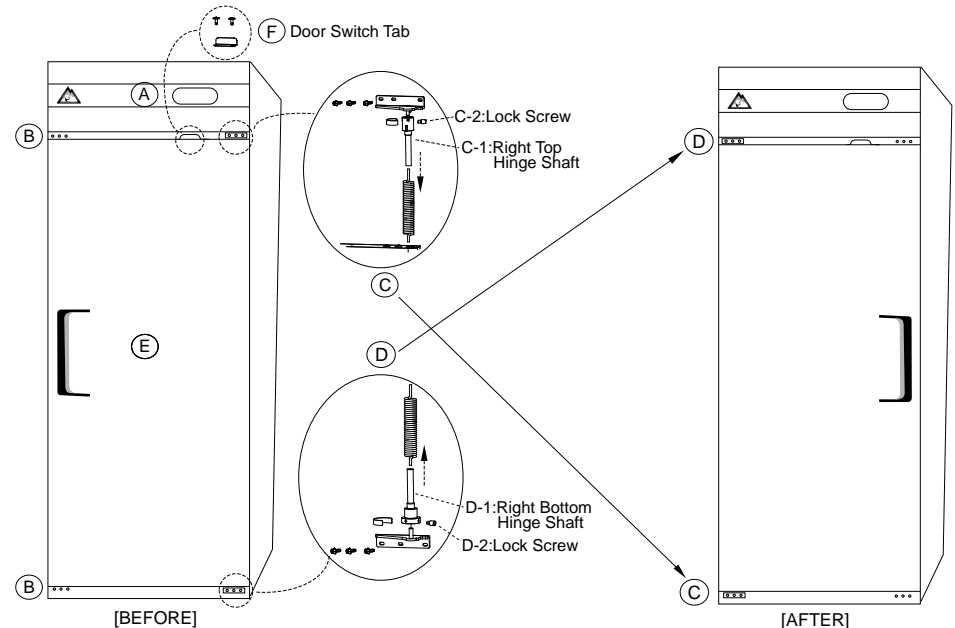

BEFORE YOU CALL

Please check the following before requesting service

	Symptom	Possible Solutions
	Condensing unit fails to start	a. Check to see that the electrical cord has not been disconnected. b. Check to see that the unit is turned on.
	Cabinet does not maintain proper temperature	a. Check the door gasket for proper seal. b. Check to see if the temp. control setting is too high and adjust as necessary. c. Avoid installing the unit next to heat generating equipment and direct sunlight. d. Avoid storing hot contents. e. Make sure the doors are fully closed.
	Refrigerated compartment is too cold	a. Adjust the temperature control to a warmer setting.
	Noisy operation	a. Check for loose parts. b. Check for tubing rattle. c. Check for a bent fan blade. d. Check for damaged fan motor bearings. e. Check that the unit is stable. f. Check that the cabinet is level.
	Condensation on the exterior surface	a. Condensation on the exterior surface of the unit is perfectly normal during periods of high humidity. b. Check door alignment and gaskets for proper seal.
	Sound of water dripping	a. This is the sound of the refrigerant circulating during the compressor rest period and it is normal.
	Exterior walls are warm	a. Heaters have been placed around the door openings to prevent condensation buildup. This is normal.
	Condensation on the interior	a. Condensation can occur during hot and humid weather with frequent or prolonged door opening. This is normal. b. The doors might not be closed properly. Check door alignment and gaskets for proper seal.

Shelves

The unit's shelves are adjustable so that the refrigerated compartment can be configured to suite your needs.

The shelf clip pilasters are spaced and labeled in 1" increments for your convenience.

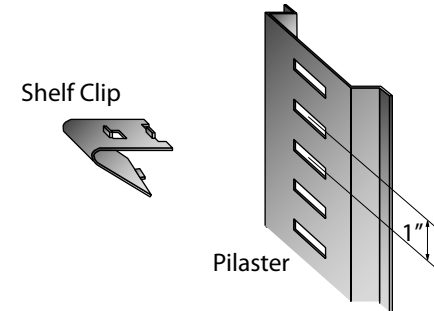

To install a shelf, hook the shelf clips into the pilasters by inserting the top part of the clips first and then the bottom. Each shelf requires 4 clips.

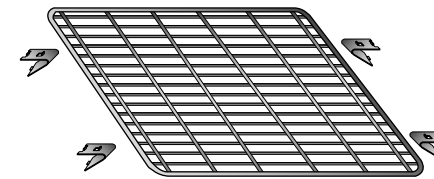

To remove a shelf, start by unloading the shelf. Second, remove the shelf itself. Finally, remove the shelf clips by tilting them up and allowing the bottom of the clip to come out first and then remove the top part of the clip from the pilaster.



Warning - Never attempt to adjust a shelf when loaded!

Model	ESR1 (Refrigerator)	ESF1 (Freezer)	ESRH2 (Refrigerator)	ESFH2 (Freezer)	ESR2 (Refrigerator)	ESF2 (Freezer)
Capacity(Cu.Ft.)	23	23	23	23	48	48
Door	1	1	2 (Half)	2(Half)	2	2
Shelves	3	3	3	3	6	6
Compressor (HP)	1/3	1/2	1/3	1/2	1/3	1/2 x 2ea
Power (V-Hz-Ph)	115-60-1	115-60-1	115-60-1	115-60-1	115-60-1	115-60-1
Temp. Range(F)	32 ~ 42	-4~ 32	32 ~ 42	-4 ~ 32	32 ~ 42	-4 ~ 32
Refrigerant	R-134a	R-404a	R-134a	R-404a	R-134a	R-404a
Crated Weight(LBS)	284	289	289	293	384	448
Amps(A)	3.38	8.12	3.38	8.12	4.50	15.89
Ext. Dimensions (W x D x H inches)	29 1/4 x 31 3/4 x 74 1/4	29 1/4 x 31 3/4 x 74 1/4	29 1/4 x 31 3/4 x 74 1/4	29 1/4 x 31 3/4 x 74 1/4	49 3/4 x 31 3/4 x 74 1/4	49 3/4 x 31 3/4 x 74 1/4

Model	ESRF2 (Dual Temp)	ESWR2 (Refrigerator)	ESWF2 (Freezer)	ESWRF2 (Dual Temp)	ESWQ3 (Dual Temp)	ESR3 (Refrigerator)
Capacity(Cu.Ft.)	22(R) 22(F)	55	55	26(R) 26(F)	39(R) 13(F)	71
Door	2	2	2	2	2	3
Shelves	6	6	6	6	5	9
Compressor (HP)	1/3(R) 1/2(F)	1/3	1/2 x 2ea	1/3(R) 1/2(F)	1/3(R) 1/2(F)	1/3 x 2ea
Power (V-Hz-Ph)	115-60-1	115-60-1	115-60-1	115-60-1	115-60-1	115-60-1
Temp. Range(F)	32~42(R) -4~32(F)	32 ~ 42	-4 ~ 32	32~42(R) -4~32(F)	32~42(R) -4~32(F)	32 ~ 42
Refrigerant	R-134a(R) 404a(F)	R-134a	R-404a	R-134a(R) 404a(F)	R-134a(R) 404a(F)	R-134a
Crated Weight(LBS)	456	421	503	496	470	578
Amps(A)	12.85	4.50	15.89	12.08	12.08	9.49
Ext. Dimensions (W x D x H inches)	49 3/4 x 31 3/4 x 74 1/4	59 x 31 3/4 x 74 1/4	59 x 31 3/4 x 74 1/4	59 x 31 3/4 x 74 1/4	59 x 31 3/4 x 74 1/4	75 x 31 3/4 x 74 1/4

Model	ESF3 (Freezer)	ESRF3 (Dual Temp)	ESR12D2 (Refrigerator)	ESR2D2 (Refrigerator)	ESR2D4 (Refrigerator)	ESRF2D2 (Dual Temp)
Capacity(Cu.Ft.)	71	46(R) 22(F)	23	48	48	22(R) 22(F)
Door	3	3	1(Half) 2(Drawer)	1(Full) 1(Hal) 2 (Drawer)	2(Hal) 4 (Drawer)	1(Full) 1(Hal) 2 (Drawer)
Shelves	9	9	2	5	3	5
Compressor (HP)	1/2 x 3ea	1/3(R) 1/2(F)	1/3	1/3	1/3	1/3(R) 1/2(F)
Power (V-Hz-Ph)	230-60-1	115-60-1	115-60-1	115-60-1	115-60-1	115-60-1
Temp. Range(F)	-4 ~ 32	32~42(R) -4~32(F)	32 ~ 42	32 ~ 42	32 ~ 42	32~42(R) -4~32(F)
Refrigerant	R-404a	R-134a(R) 404a(F)	R-134a	R-134a	R-134a	R-134a(R) 404a(F)
Crated Weight(LBS)	650	589	366	423	534	531
Amps(A)	12.36	12.62	4.94	5.30	5.55	12.50
Ext. Dimensions (W x D x H inches)	75 x 31 3/4 x 74 1/4	75 x 31 3/4 x 74 1/4	29 1/4 x 31 3/4 x 74 1/4	49 3/4 x 31 3/4 x 74 1/4	49 3/4 x 31 3/4 x 74 1/4	49 3/4 x 31 3/4 x 74 1/4

Model	ESWQ2D2 (Dual Temp)	ESGR1 (Refrigerator)	ESGR2 (Refrigerator)	ESGWR2 (Refrigerator)	ESGR3 (Refrigerator)
Capacity(Cu.Ft.)	39(R) 13(F)	23	48	55	71
Door	1(Full) 1(Hal) 2 (Drawer)	1 (Glass)	2 (Glass)	2 (Glass)	3 (Glass)
Shelves	5	3	6	6	9
Compressor (HP)	1/3(R) 1/2(F)	1/3	1/2	1/2	1/3+ x 2ea
Power (V-Hz-Ph)	115-60-1	115-60-1	115-60-1	115-60-1	115-60-1
Temp. Range(F)	32~42(R) -4~32(F)	32 ~ 42	32 ~ 42	32 ~ 42	32 ~ 42
Refrigerant	R-134a(R) 404a(F)	R-134a	R-404a	R-404a	R-134a
Crated Weight(LBS)	573	311	434	478	585
Amps(A)	12.24	4.44	7.45	7.45	9.49
Ext. Dimensions (W x D x H inches)	59 x 31 3/4 x 74 1/4	29 1/4 x 31 3/4 x 74 1/4	49 3/4 x 31 3/4 x 74 1/4	59 x 31 3/4 x 74 1/4	75 x 31 3/4 x 74 1/4

[NOTE]
Ext. height does not include 5" overall height casters.
Drawer pans are not include for Door & Drawer Combo Upright Reach-Ins.
Specifications subject to change without notice.

The operation of the product and all electrical components is controlled by a digital monitoring and control system (PCB control box) located on top of the cabinet.

The compartment's temperature preset is 35°F for refrigerators, and -4°F for freezers. Please follow the steps below to change the temperature to the desired setting.

[Single Temperature Unit]

1. Press the "TEMP SET" button, then the red light will flash. The number on the display is the current setting.
2. Set the new desired temperature by pressing "HIGH" or "LOW" while the light is flashing.
3. The control system will display the current cabinet temperature a few seconds later after the setting is completed.

[Dual Temperature Unit]

1. Press the "TEMP SET" button, then the red light (refrigerator side) will flash. The number on the display is the current setting.
2. Set the new desired temperature by pressing "HIGH" or "LOW" while the light is flashing.
3. Repeat step 1 to set the freezer compartment temperature.
(To skip the refrigerator setting and go directly to freezer setting, press the "TEMP SET" button twice.)

[WARNING]

Setting the temperature out of the recommended ranges will void the product's warranty.
32°F ~ 41°F for refrigerator and -4°F ~ 34°F for freezer

[How to Set Your Desired Temperature.]

1. Be sure main power of the unit is connected to a 115V/60Hz/1Ph power supply. When the unit is turned on for the first time, the digital indicator will display the actual compartment temperature.
2. Press the "REFRIGERATOR ON/OFF (FREEZER ON/OFF)" button to start. The red indicates the unit is on.
3. Press the "TEMP SET" button, the light will blink.
4. Set your desired temperature by pressing the "HIGH" or "LOW" button. The digital indicator will change from the current cabinet temperature to the setting temperature. Within 4 seconds after setting your desired temperature, the digital indicator will display the actual compartment temperature again.
5. After the above procedures are successfully completed, The system will operate within 5 minutes.

REFRIGERATOR

FREEZER

REFRIGERATOR
ON/OFF

MANUAL
DEFROST

FREEZER
ON/OFF

TEMP. SET

HIGH

LOW

(RECOMMENDED SETTING TEMP)
REFRIGERATOR: 35 °F
FREEZER: -4 °F

Caution: Repairs by authorized Personal only.

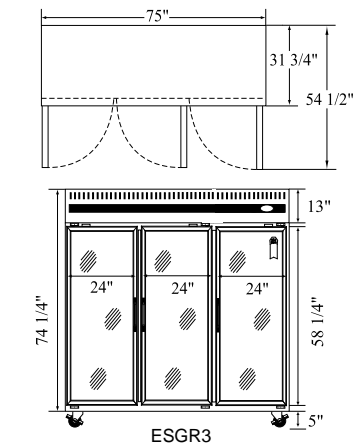
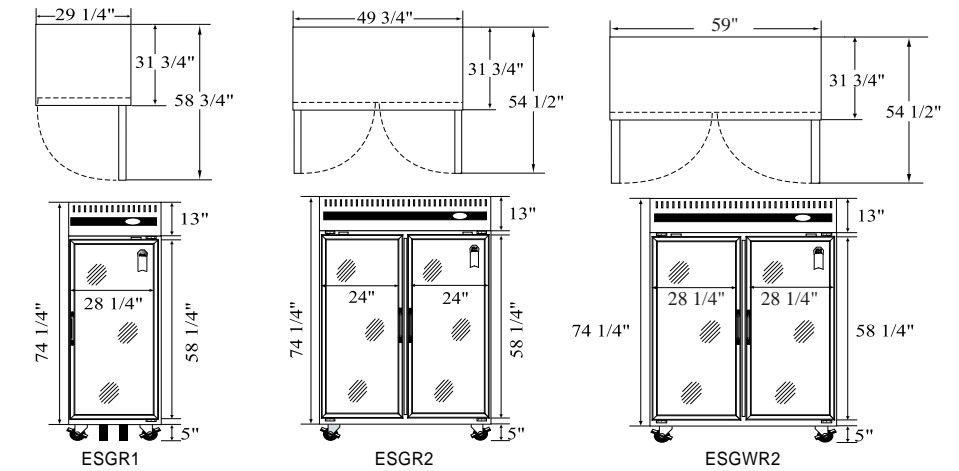
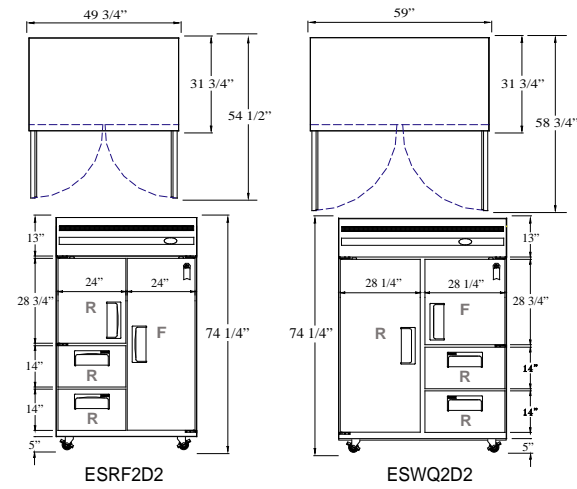
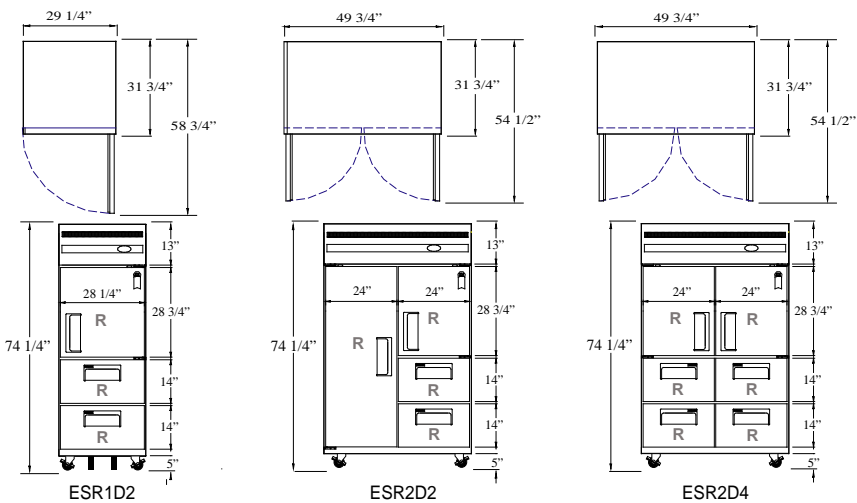
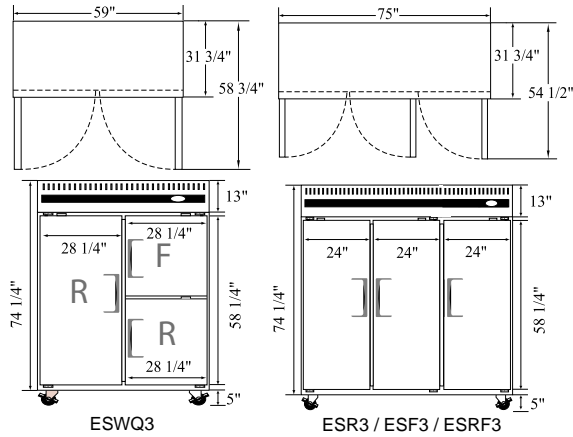
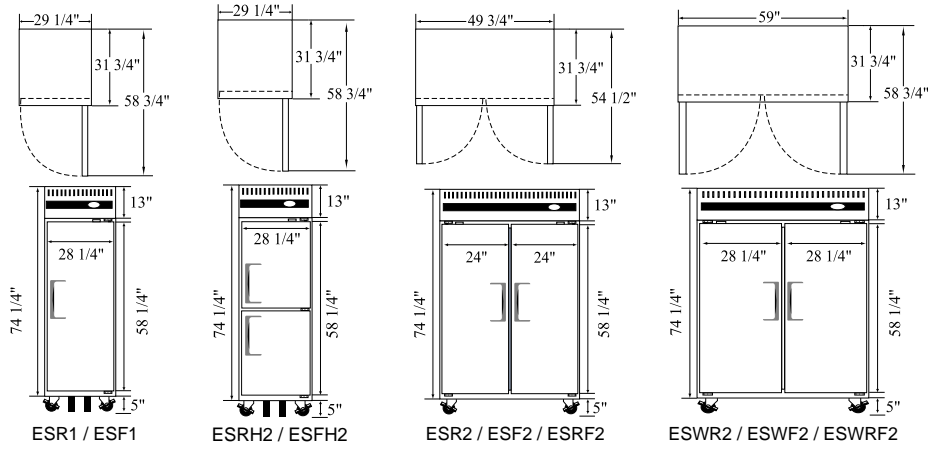

CONDENSER COIL MAINTENANCE

Failure to maintain a clean condenser coil will eventually result in compressor failure and product loss. Mechanical failures due to a lack of or improper maintenance are not covered under warranty. Keeping the condenser coil clean will maximize energy savings. Cleaning of the condenser coil is part of regular maintenance and is not covered under warranty.

CONDENSER COIL CLEANING PROCEDURE

Please use the following steps to clean the condenser coil. If you have any questions regarding this procedure, please call the Everest customer service department at (800) 444-6285.

1. Unplug the unit from the wall.
2. Roll the unit away from the wall so that the rear can easily be accessed.
3. Clean the condenser coil using a vacuum or brush. The fins of the condenser coil should only be cleaned and swept in the direction of the fins, which is up and down. Be careful not to bend the fins.
4. In some instances, the condenser coil may require professional cleaning due to a buildup of grease and dust. In this case, contact a local refrigeration company to take care of this for you.
5. Be sure that all tools have been removed from the condenser area and that nothing will obstruct the motion of the condenser fan blade.
6. Plug the unit back in, turn on, and check that all temperatures are set correctly.

The warranty card below must be submitted to Everest within thirty (30) days of purchase.

WARRANTY REGISTRATION CARD

Business Name : _____ Telephone : (_____) _____
 Address : _____
 City : _____ State : _____ Zip : _____
 Place of Purchase : _____ Date Purchased : _____ Date Installed : _____
 Cabinet Serial No : _____ Model No : _____

INSTANT ADDITIONAL SIX (6) MONTHS EXTENDED PARTS & LABOR WARRANTY

We offer a FREE additional six (6) Months extended parts & labor warranty to customers who return this warranty registration card to Everest within one (1) month of the date of purchase.

EXTENDED WARRANTY (OPTIONAL)

Additional 1 year parts & labor extended warranty available for only \$199.00.

Please make check payable to "EVEREST Refrigeration" and return it with this registration card.

Yes, I would like to purchase the extended warranty. No, I have declined to purchase the extended warranty.

Name of Business Owner : _____ Date : _____

Signature of Business Owner : _____

EVEREST LIMITED WARRANTY

EVEREST warrants to the original purchaser of every new EVEREST unit, the cabinet and all parts thereof, to be free from defects in material or workmanship, under normal and proper use and maintenance service as specified by EVEREST and upon proper installation and start-up in accordance with the instruction packet supplied with each unit. Our obligation under this warranty is limited to a period of one (1) year from the date of original installation or fifteen (15) months after shipment date from EVEREST, whichever ever occurs first.

Any part covered under this warranty that is determined by EVEREST to have been defective within one (1) year of original installation or fifteen (15) months after shipment date from the manufacturer, which ever occurs first, is limited to the repair or replacement, including labor charges, of defective parts or assemblies. The labor warranty shall include standard straight time labor charges only and reasonable travel time, as determined by EVEREST.

WARRANTY CLAIMS

All warranty claims for labor or parts must be made directly through EVEREST. All claims shall include: unit model number, cabinet serial number, proof of new product purchase, installation date, and all pertinent information related to the alleged defect. For compressor warranty claims, the compressor tag shall be returned to EVEREST with the above listed information.

WARRANTY EXCLUSIONS

EVEREST's sole obligation under this warranty is limited to either the repair or replacement of parts, subject to the additional limitations below. This warranty neither assumes nor authorizes any person to assume obligations other than those expressly covered by this warranty.

A. INDIRECT OR CONSEQUENTIAL DAMAGE

EVEREST does not warrant economic loss, profit loss, or special, indirect or consequential damages including without limitation, losses or damages arising from food or product spoilage claims caused by refrigeration failure.

B. IMPROPER USAGE

EVEREST is not responsible for parts or labor coverage for component failure and or other damages resulting from improper usage, installation or failure to clean and/or maintain product as set forth in the user's manual provided with this unit. All EVEREST products are designed for commercial usage, not for residential use. Therefore, the warranty will not be honored if product is installed in a residential house.

C. WARRANTY IS NOT TRANSFERABLE

Warranty is limited to only the original purchaser/user to whom delivered. It is not transferable.

D. ALTERATION, NEGLIGENCE, MISUSE, ABUSE, ACCIDENT, DAMAGE DURING TRANSIT OR INSTALLATION, FIRE, FLOOD, ACTS OF GOD.

EVEREST is not responsible for malfunctions due to alteration, neglect, misuse, abuse, accident, damage during transit or installation, fire, flood, storm, and/or other acts of God. And EVEREST is not responsible for any improper electrical connections resulting from electrical power failure, the use of extension cords, and low voltage or voltage drops to the unit.

E. UNAUTHORIZED MODIFICATION

EVEREST is not responsible for the repair or replacement of failed or damaged components resulting from unauthorized modifications to units or the use of non-standard parts without prior written approval from EVEREST.

F. RESIDENTIAL, NON-COMMERCIAL USE

This warranty does not apply to a unit installed in a residential setting. This unit is for commercial use only.

G. OUTSIDE THE U.S.

This warranty does not apply to any parts and/or labor warranty claims made on units sold or used outside of the United States.

ADDITIONAL FOUR (4) YEAR COMPRESSOR WARRANTY

In addition to the warranty set forth above, EVEREST warrants the hermetically sealed compressor for an additional four (4) years, not to exceed sixty (60) months from the date of shipment from EVEREST, provided upon receipt of the compressor, manufacturer examination shows the sealed compressor to be defective. This compressor warranty does not apply to any of the other parts of the unit, including compressor start components, which are covered under the one (1) year parts and labor warranty.

These warranties are exclusive and in lieu of all other warranties, expressed or implied, and all other obligations or liabilities on our part, and we neither assume nor authorize any other person to assume for us any other obligation or liability in connection with the sale of said refrigeration units or any part thereof.

ADDITIONAL SIX (6) MONTHS PARTS AND LABOR WARRANTY WHEN WARRANTY REGISTRATION CARD IS RETURNED TO EVEREST WITHIN THIRTY (30) DAYS OF PURCHASE.