

# Aqua Safe Series Replacing diaphragms

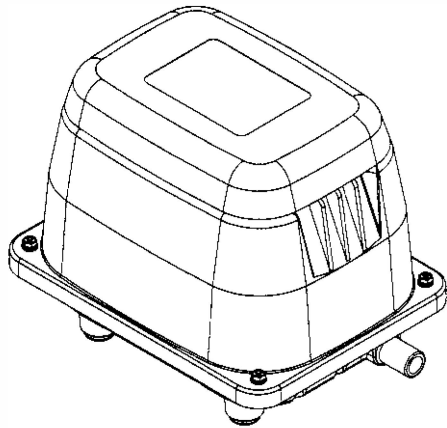

## Regarding maintenance

- To avoid electrical shock, do not touch power plug or unit with wet hands.
- Make sure that compressor/blower is unplugged before maintenance.
- To prevent burning, please wait until the unit cools down.
- To prevent electronic shock, do not expose the unit to moisture or outside on a rainy day during maintenance.

(1)

⑦ Attach new diaphragm mounting block to one side of rod (refer to fig.11). Insert rod into casing block as reverse procedure to remove rod from casing block. Attach opposite new diaphragm to mounting block (refer to fig.12). To avoid failure, make sure that no foreign material or fragments such as screws stick to permanent magnet on rod or electromagnet.  
⇒ To avoid failure, use new U locknuts after each maintenance. (U locknut loses its lock function once it is removed.)

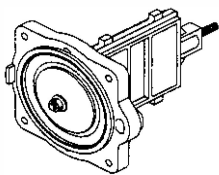

Fig.11

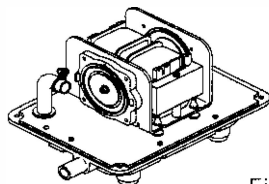

Fig.12

⑧ After reattaching new diaphragm mounting block, tighten the casing block with 4 screws as reverse procedure when removing (refer to fig.13). Reattach the L-shaped tube to the casing nozzle. Tighten the hose with spring clamp (refer to fig.14).

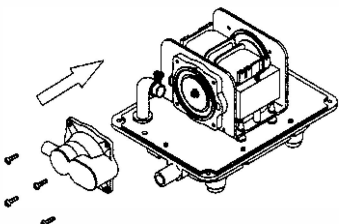

Fig.13

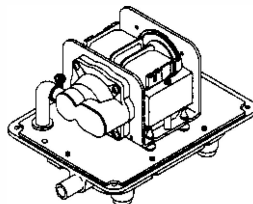

Fig.14

(5)

- To maintain initial performance level, replace diaphragms and valves annually.
- To prevent performance decrement and lifetime decrease, replace both diaphragms and all valves at the same time.
- After changing diaphragm, make sure that if SP switch is not broken before reattaching upper housing.
- To avoid noise increase or water intrusion, replace base gasket with new one in case base gasket comes unstuck during replacing diaphragms.
- Before maintenance, take off your watch as it may be broken by the strong magnet that is included in compressor/pump unit.
- Please keep the rod away from magnetic cards, disks and other magnetic things as breakage may occur.

① Be sure to unplug the pump unit before maintenance.  
● Loosen all 4 screws and remove upper housing. If it is stuck, insert screwdriver between upper housing and lower housing to pry apart (refer to fig.1 and 2).  
⇒ If it is stuck, tap on the part indicated by "★" in Fig.1.

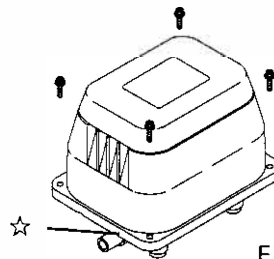

Fig.1

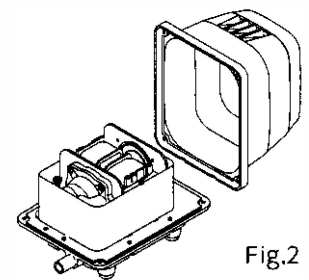

Fig.2

(2)

⑨ After completing whole process, make sure that the rod does not come into contact with the electronic magnet. If the safety pin on the SP switch is broken, replace the pin with new one.

### How to replace the safety pin of the SP switch

⑩ Insert the safety pin through the electrode, the L-shaped lever and the beam (refer to fig.15).

⑪ Push the safety pin slowly, then attach the locking collar from opposite side. The collar is locked with the sound of a click when it is set properly (refer to fig.16).

⇒ To avoid failure or damage to the permanent magnet or electronic magnet, remove all pieces of broken pin and the collar. To avoid performance decrease or failure, do not reuse the locking collar. Replacing safety pin should be after changing diaphragms, otherwise it may brake.

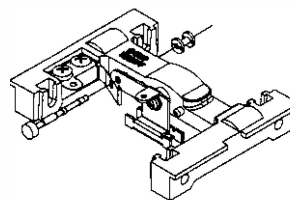

Fig.15

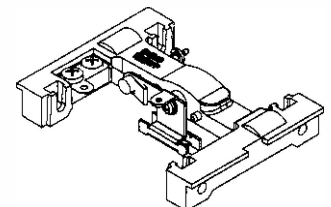

Fig.16

(6)

③Remove the sound absorber and the L-shaped tube from the casing nozzle gripping spring clamp(refer to fig.3). Loosen the 4 screws on the casing and remove the casing block(refer to fig.4).

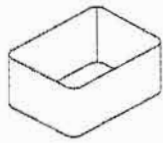

Fig.3

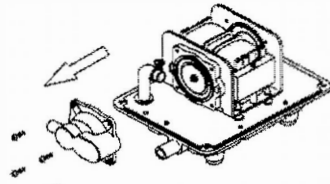

Fig.4

④Loosen the U locknut and washer on one side of diaphragm mounting block and remove the Diaphragm mounting block (refer to fig.5) . Pull out the other side of diaphragm mounting block(do not loosen the U locknut and washer). Remove the block from Rod (refer to fig.6).

⇒When pulling the rod, take care not to touch the SP switch lever and the rod. It may cause failure or damage to the safety pin.  
**Danger:** Fingers can be severed by unexpected strong magnetic attraction.

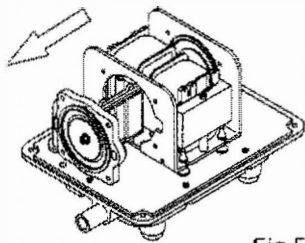

Fig.5

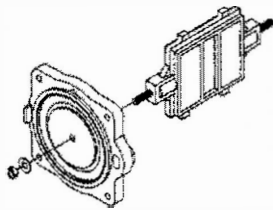

Fig.6

(3)

●Reattach sound absorber over the unit, and reattach upper housing(refer to fig.17). Tighten the 4 screws equally(refer to fig. 18).

⇒Tightening screws unequally may cause damage. Be sure to tighten the 4 screws equally.

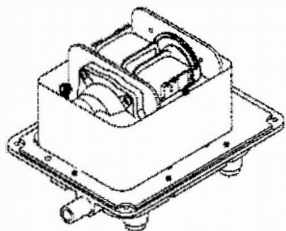

Fig.17

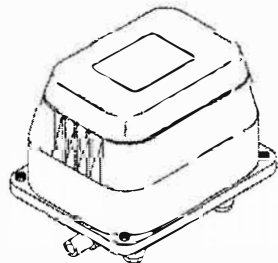

Fig.18

### Procedure to replace base gasket

Base gasket may be damaged by removing upper housing. To avoid noise increase or water intrusion, make sure to replace base gasket with new one.

①Loosen 6 screws on steel plate (refer to fig. A). If it is stuck, tap on convex part that is indicated by "☆" to remove (refer to fig. B).

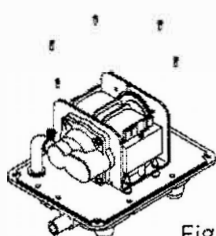

Fig.A

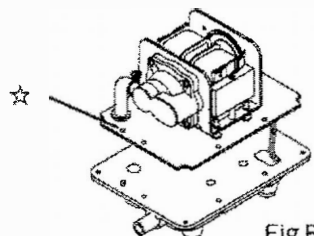

Fig.B

(7)

⑤Remove the diaphragm ring and diaphragm from diaphragm base(refer to fig.7 and 8). If it is stuck, remove the diaphragm with pliers.

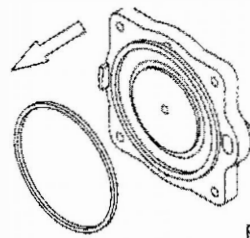

Fig.7

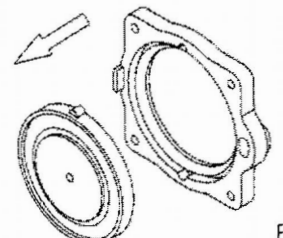

Fig.8

⑥Insert new diaphragm onto the diaphragm mounting block to fit convex part (refer to fig.9) and attach the new diaphragm ring(refer to fig.10).

⇒To avoid failure or performance decrease, make sure to install the diaphragm ring. To prevent any injury, please do not attach old ring during as it may be broken.

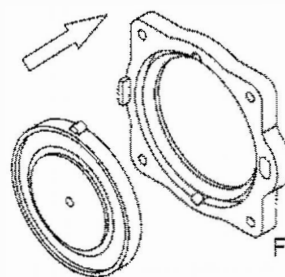

Fig.9

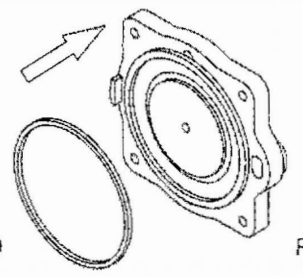

Fig.10

(4)

②Remove the base gasket following power cord (refer to fig.C). Make sure that the gasket is completely removed from lower housing. In case part of the gasket remains on lower housing, please remove the pieces. Attach new gasket and reattach power cord as reverse procedure to removing them(refer to fig.D). (For the 2 ports type pump, please remove the solenoid terminal once)

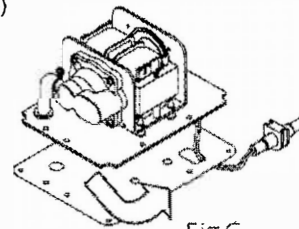

Fig.C

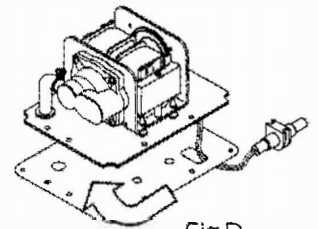

Fig.D

③Attach the steel plate on the lower housing and tighten it with 6 screws(refer to fig. E).

Take care not to trap the lead wire between the steel plate and the lower housing. Lift up the lead wire while attaching the steel plate and tighten the screws. If the cord becomes trapped, it may cause an electric leak (refer to fig.F).

Tuck down the wire into lower housing(refer to fig.G).

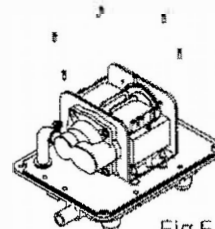

Fig.E

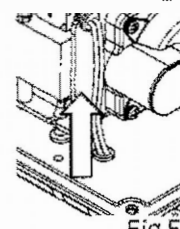

Fig.F

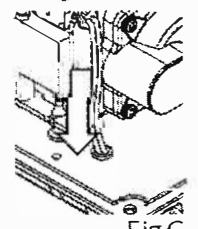

Fig.G

Specification or design may be changed without notice.  
 We appreciate your understanding in advance.

(8)