



eFOLDi®



# eFOLDi User Manual

Model: Lite



SunTech UK Ltd

**Purchased from:**

---

---

---

**Date of purchase:**

---

**Serial number:**

---

**Please see image showing the location of the serial number.**



## Contents

<b>1</b>	<b>Welcome</b>	<b>2</b>
<b>2</b>	<b>Terms, conditions and disclaimers</b>	<b>3</b>
<b>3</b>	<b>Product overview</b>	<b>6</b>
<b>4</b>	<b>Components</b>	<b>7</b>
<b>5</b>	<b>Safety guidance</b>	<b>8</b>
<b>6</b>	<b>Folding instructions</b>	<b>12</b>
<b>7</b>	<b>Drive your scooter</b>	<b>17</b>
<b>8</b>	<b>Battery and Charging</b>	<b>20</b>
<b>9</b>	<b>Checks and maintenance</b>	<b>23</b>
<b>10</b>	<b>Technical specification</b>	<b>24</b>
<b>11</b>	<b>Appendix</b>	<b>25</b>

## Welcome

Thank you for choosing an eFOLDi product as your mobility solution.

I'm Sumi Wang, the founder of SunTech UK and would like to welcome you to the eFOLDi family of users.

SunTech UK manufactures a range of assistive technologies to help you get the most from life. Our mission is to give our customers freedom, friendship and fun with a range of easy to use, convenient and market leading mobility solutions.

Your eFOLDi has been manufactured to the highest standards and quality checked by our own pre-sales technicians before delivery, to provide you with a product that will give many years of freedom and fun with reliable service.

Please take some time to read the user manual and the supplied documents before using your eFOLDi for the first time, this will help you understand the product and help you obtain maximum enjoyment and safety from your new eFOLDi product(s). You will quickly become familiar with the features of your eFOLDi with a little practice.

SunTech UK prides itself on its high-quality products and customer support so please remember to register your product(s) at: <https://efoldi.com/register-warranty>

These will help us to assist you in the event of any difficulties you may experience in the future. I am sure you will find your eFOLDi to be a reliable friend and companion and I thank you for your custom and your trust in our products.

Yours,



Sumi Wang

---

## Terms, conditions and disclaimers

The terms 'us', 'we', 'our', 'SunTech UK' and 'SunTech UK Ltd' mean SunTech UK Limited, which is a UK registered company, limited by guarantee, registered with Companies House, number 06906908. The terms 'website' means the website found online at [www.efoldi.com](http://www.efoldi.com). The terms 'you', 'your', 'user' and 'rider', mean the person using the eFOLDi not withstanding any person(s) handling the eFOLDi on behalf of the user, if different to the user, including general handling, maintenance, repairs and so on.

## Purchaser's agreement

By accepting delivery of this eFOLDi, you undertake to not change, alter or modify this eFOLDi and/or any parts supplied with it or subsequently for it, and/or render inoperable or unsafe, any guards, shields or other safety features of this product; fail, refuse or neglect to install any retrofit kits from time to time, as may be provided by SunTech UK Ltd to enhance and/or preserve the safe use of this product . You also agree to accept and abide, by/with the terms and conditions contained herein and as may be revised from time to time and updated on our website, being immediately applicable. By using the eFOLDi and/or accessories and/or components supplied with/or for the eFOLDi, the user acknowledges having read and understood the use(s) and limitations of the product(s) without exceptions. This shall not act as a waiver of any implied warranties, which customer retains, as provided by law.

Warranties will be void and SunTech UK Ltd will accept no responsibility whatsoever or howsoever, in instances of misuse and/or abuse of the products, in part or in full, by the user and/or any unauthorised persons, which may include (but not to be limited to); the user(s) failing to comply with all legal requirements and guidelines, wherever and/or however it is used or intended to be used, lack of or inappropriate maintenance, maintenance (apart from the routine maintenance as described in this manual by the user) by anyone not approved to do so, unapproved repairs, unauthorised disassembly of the vehicle and/or components includ-

ing (but not limited to) battery pack(s) and controllers, unapproved modifications or alterations, failure to ensure correct folding and unfolding procedures are followed precisely and in full, damage or injury howsoever caused, failure to apply all reasonable and appropriate safety precautions at all times, improper use of the vehicle and/or parts and/or accessories being used by more than one person at any times, use in any competitive sport, racing, stunts, jumping or other similar activity.

Our liability and the liability of our suppliers, to you/or any third parties in any circumstances is limited to the user's cost of qualifying products purchased. Qualifying products as acceptable for the return, as outlined in the return policy, as stated on the website online at: [www.efoldi.com/return-policy](http://www.efoldi.com/return-policy).

Information in this user manual is subject to change without prior notice. For the latest updates and information, please go to our website online at: [www.efoldi.com](http://www.efoldi.com).



## The scooter should NOT be used by:

People who are unable to:

- Fold or unfold it using both hands\*;
- Transfer themselves onto the seat\* and remain in a seated upright position at all times, without assistance while the vehicle is in motion;
- Place and keep your feet on the Lite;
- Operate all controls fully and as intended;
- Steer competently and appropriately at all times and in all conditions;
- Maintain appropriate awareness of all relevant circumstances for each journey and take appropriate action as may be required to avoid mishap;
- Lift it in whole or in part as may be required dependent upon user's needs\*.

\*Unless accompanied by a person sufficiently able and competent to carry out that task.

## Product compliance:

Safety:	EN12184 and ISO 7176-15
EMC:	ISO7176-21
Risk management:	ISO14971
The European Medical Devices:	Directive of 93/42/EEC

## Shipping and delivery:

By checking against your sales order or invoice, make sure your delivery is complete, as some components may be individually packaged. If you do not receive a complete delivery, please contact us immediately. Where damage has occurred during transport, either to the packaging or the content, please contact the delivery company responsible.

## Product overview

eFOLDi Lite is one of the worlds lightest, most compact, folding mobility scooter. Weighing only 17kg with battery and no larger than a small suitcase when folded. Amazingly easy to setup and fold - fully airline compliant, eFOLDi Lite is the perfect super light-weight travel companion.



(a) Suitcase mode



(b) Trolley Mode



(c) Scooter Mode

Model: Lite



## Components

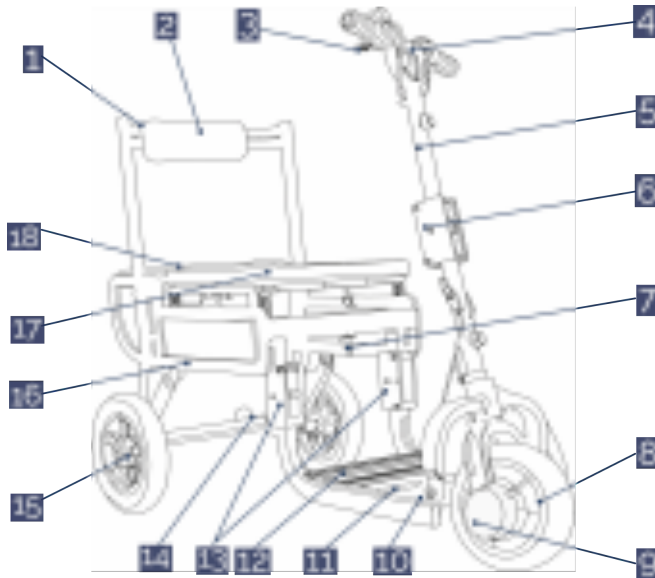

1	Backrest frame	2	Backrest pad
3	Accelerator/gradual brake lever	4	Handle bar
5	Steering column	6	Steering stem folding lock
7	Steering stem/frame latch	8	Front motor
9	Front brake lock lever *	10	Stainless steel hinges
11	Footrest and battery compartment	12	Controller compartment
13	Hinge to fold footrest	14	2 inch suitcase wheels
15	9 inch Rear wheels	16	Main frame
17	Main seat pad	18	Rear seat pad

\*The brake is on the other side of wheel, the above image is for illustration purpose only.

**Table 1: Model Lite Components**

## Safety guidance



### Attention

- It is the user's responsibility to read the manual and supplied documents before using the eFOLDi and to follow all of the recommendations contained within, to fully comply with all local laws of their countries and localities and to use the eFOLDi with due diligence and regard to other road users and pedestrians.
- The eFOLDi is simple to use, but its folding mechanism can cause significant injury if used inappropriately and handled without due care and diligence. To avoid any risk of injury ensure hands, fingers, jewellery, clothing and other objects are not allowed to interfere with the folding mechanism or moving parts of the eFOLDi and study the manual carefully before you start operating your eFOLDi.
- It is advised that the user familiarise themselves with the folding and unfolding procedure before venturing outside. The user should also ensure that they familiarise themselves with the controls and handling of the scooter in a safe area away from obstacles and other pedestrians or road users.
- eFOLDi users are recommended to wear appropriate clothing when using a mobility scooter which should include an approved helmet, sturdy shoes or boots, appropriate gloves and high visibility protective clothing as a safety precaution.
- Fully charge the battery(ies) before first use and follow the guidelines in this manual for prolonging the life of your battery.
- Your eFOLDi Lite should only be stood on its main rear wheels and suitcase wheels when it is on level and stable ground.

## Caution:

When travelling at speeds greater than a slow walking pace be sure to slow down before turning.

Do NOT ride over rough, cobbled, muddy or loose gravel surfaces. Your eFOLDi is designed for smooth and firm footpaths, roads and pedestrian areas only.

The stopping distance on slopes can be significantly greater than on level ground; The scooter surface temperatures can increase when exposed to external sources of heat (e.g. sunlight)

Approach kerbs (maximum height of 4cm) carefully and at right angles and cross them slowly.

Any vehicle can be dangerous to its rider/driver and other road users and pedestrians.

Always ride/drive responsibly, respectfully and with due care to others.



Your eFOLDi Scooter is NOT a toy and is not recommended for people under the age of 14. Do NOT allow children to play with or on the scooter. The internal folding mechanism can cause injury to small hands.

Do NOT rush when folding or unfolding the eFOLDi scooter.

Do NOT for any reason put your hands into the mainframe of the scooter, especially in the last step of the folding process. This is because your hands and fingers can get trapped in the main levers and pivots and serious injuries can be caused.

Do NOT carry passengers on the eFOLDi scooter. Carrying passengers on the eFOLDi may affect the centre of gravity, resulting in tipping over or falling.

## **When unfolding/folding your eFOLDi Lite ensure:**

- The scooter is positioned on a level floor or ground.
- Main switch is switched off.
- All latch pins are properly secured in place, as stated on the instructions and shown on the illustrations.

## **Safety check before use:**

It is highly recommended that you perform a safety check before each use to make sure your eFOLDi operates smoothly and safely.

- Check all electrical connections. Make sure they are secure and not corroded;
- Check and test the brake system;
- Check frequently for any loose fasteners, fixings and other components.

## **EMC WARNING STATEMENT**

The interference from radio wave sources such as radio stations, TV stations, two way radios or cellular phones can cause the mobility scooter to release its brakes, move by itself, or move in unintended directions. It can also permanently damage the mobility scooter control system.

The intensity of the interfering EM energy can be measured in volts per meter (V/m). Each mobility scooter can resist EMI up to a certain intensity. This is called the "EMI immunity level". The higher the EMI immunity level, the greater the protection from EMI. Currently the eFOLDi scooter has an immunity level of at least 20V/m, which provides useful protection from the common sources of EMI.

The sources of radiated EMI can be broadly classified into three

**types: 1) Hand-held portable transceivers. (normally with antenna mounted on the device) 2) Medium-range mobile transceivers, such as those used in police cars, fire trucks, ambulances and taxis. (normally with antenna mounted on the vehicle) 3) Long-range transmitters and transceivers, such as commercial broadcast transmitters (radio and TV broadcast antenna towers) and amateur (HAM) radios.**

**Other types of hand-held devices, such as cordless phones, laptop computers, AM/FM radios, TV sets and small appliances such as electric shavers and hair dryers are usually not likely to cause EMI problems.**

## Folding instructions

### Folding mode: Suitcase to Scooter



Please study the instruction and image illumination to familiarise the folding procedures and please only operate one moving part at the same time.

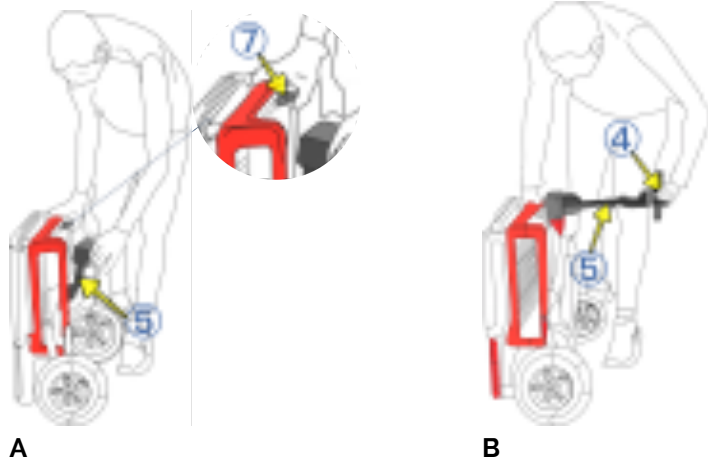

**A** Position the eFOLDi Lite vertically and release the handle bar, by pressing Steering stem/frame latch (7). Gently push the Steering column (5) forward.

**B** Grab the Handle bar (4) from the bottom and raise it 180° degrees vertically, making the Steering column (5) straight.



Do NOT for any reason put your hands into the mainframe of the scooter during each folding process. This is because your hands and fingers can get trapped in the main levers and pivots and serious injuries can be caused.

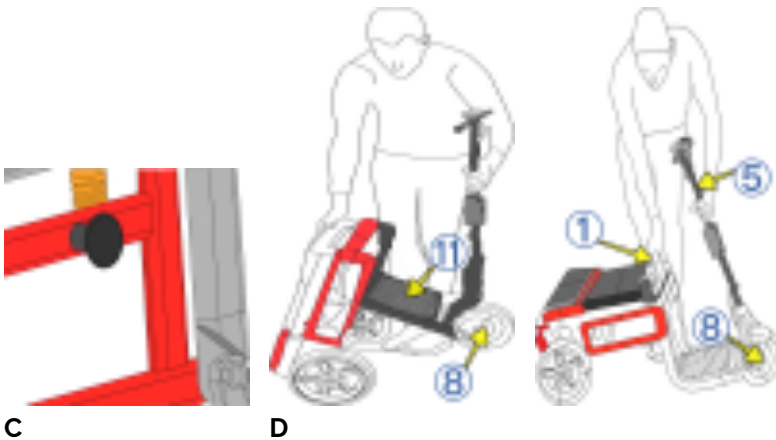

**C** Pull the knob on the side of the frame, this will release the footrest (11) and the front wheel (8).

**D** Firmly, hold the front steering column (5) and the top of backrest (1), and then push the steering column (5) forward setting the front wheel (8) on the ground and the footrest (11) on a horizontal position.



The different colours of the eFOLDi scooter and its accessories displayed in this user manual are for clear demonstration purpose only. Black colour of frame is manufacture standard.



E

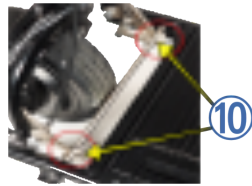

F

**E** Grab the backrest frame (1) and pull it all the way backwards until it is stable.

**F** Check the two latches of the hinge (10) at the front of footrest are fully engaged and locked.



**Do not rush when folding or unfolding the scooter.**



## Folding mode: Scooter to Suitcase

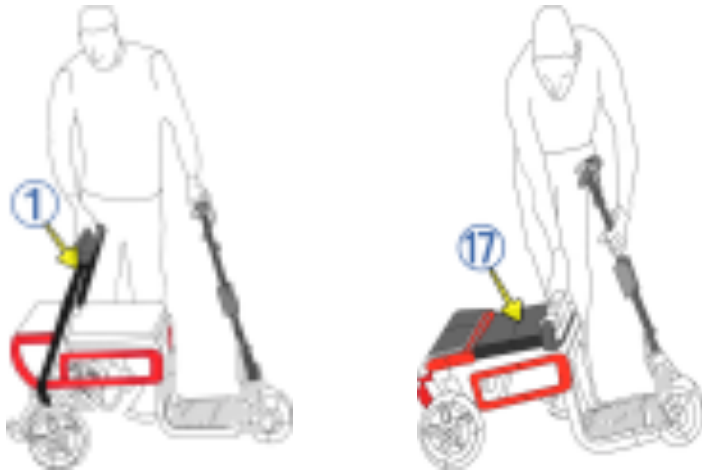

A



B

A Push and fold the backrest frame (1) on top of the main seat pad (17).

B Push the lock (6) for steering column (5) on the middle rectangular section and fold it in half, in a 180° degrees vertical rotation.

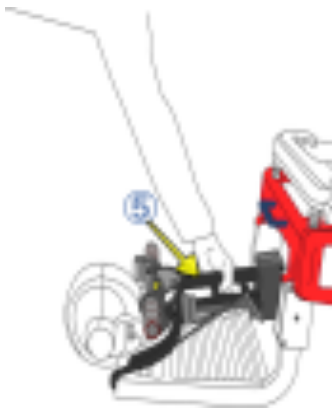

C

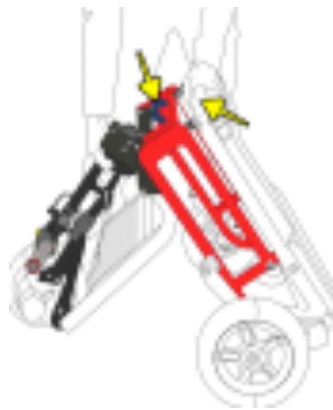

D

**C Push the folded steering column (5) towards the footrest (11) while holding the lift handle or the frame using the other hand.**

**D Finally, with one foot placed behind rear wheel to stop it rolling back, bring it up into a vertical position, grab the handle or back frame and push the steering column into the main frame until it locks in and it clicks.**



**Do NOT for any reason put your hands into the mainframe of the scooter during each folding process. This is because your hands and fingers can get trapped in the main levers and pivots and serious injuries can be caused.**

## Drive your scooter

### Safety check before use

When driving your eFOLDi, choose a route with good road conditions. The eFOLDi is designed to drive on smooth even surfaces. Unevenly paved roads or paths, potholes and other hazards, will reduce the life of any scooter and your safety.

Do not drive on steep roads or excessively cambered roads. The amount of charge remaining in the battery immediately before commencing any slope upward will be crucial to the climbing ability. Any deviation from level/horizontal surfaces should not exceed a gradient of 1:10 (6 degrees). For any climbing there are many factors that need to be considered these are: the tyre pressure and condition, the surface condition (if wet, icy or slippery, and this includes leaf cover and/or other debris, we advise against driving the slope), batteries charge and the weight of the user, all of these will affect performance.

### Front brake lock lever:

Drive mode: Must be in the forward, locked position to engage motor (picture – below left).

Freewheel/motor bypass mode: Move lever out and rearwards to disengage front brake lock (picture – below right). This will disable the brake and enable freewheel/motor bypass mode, which you will still feel some resistance. If the eFOLDi is switched on there will be a continual warning sound from the bleeper.

**Do NOT disengage brake lever whilst on hills or sloping ground - you will have to no form of braking available.**



Drive



Freewheel

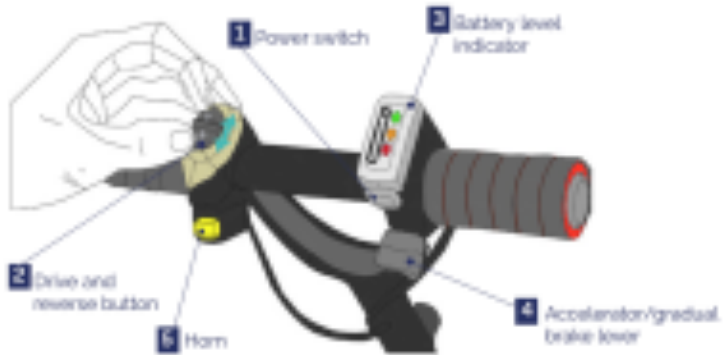

1	Power switch	2	Drive and reverse button
3	Battery level indicator	4	Accelerator/gradual brake lever
5	Horn		

Table 2: Model Lite Control bar

- Power switch (**1**) works by pushing the button underneath the battery level indicator.
- Drive and reverse button (**2**) works by pushing the button forward into the D position to Drive, R position to Reverse. **Change between D and R only works when the scooter is stationary.**
- Battery indicator (**3**) shows you how much battery there is left for usage. When the battery is fully charged all three lights will illuminate. When a single red light is shown the battery will soon need charging.
- Accelerator/gradual brake lever (**4**) is pressed the vehicle will drive, reaching a maximum speed of 4mph. The braking system will work gradually, as soon as the lever is released.
- Horn (**5**) works by pressing the yellow button under the drive and reverse button.

 **Perform the safety check before each use**  
**- see Safety Guidance section.**

**Operate the scooter:**

- To Start - Press the power switch (1) to turn on the scooter.
- Choose a gear - Choose the right gear by pushing the Drive/Reverse (2) button up or down to drive or reverse.
- To Drive/Reverse - Press the accelerator lever (4) to drive or reverse.

**Make sure you do not put too much force on the steering column and handle bar, which may cause it to bend and loose steering efficiency.**

- To Stop - Release the accelerator lever (4) to stop the scooter.

**Please leave at least 1.5 meters between the scooter and obstacles on level ground. The stop distance on slopes can be significantly greater than on level ground.**

**Caution:**

When travelling at speeds greater than a slow walking pace be sure to slow down before turning.

The stopping distance on slopes can be significantly greater than on level ground; The scooter surface temperatures can increase when exposed to external sources of heat (e.g. sunlight)

## Battery and Charging



The eFOLDi Lite battery has been designed and built specifically for the model Lite. This battery must not be used for any purpose other than as stated in this manual. Any misuse or dismantling of this battery may damage it physically and/or electrically, internally and/or externally and will not be covered by warranty.

The battery contains no user serviceable or replaceable components.

The eFOLDi Lite battery is actually a battery pack, comprising a number of Lithium Ion cells, but merely termed 'battery' for ease throughout this manual. This battery is different in characteristics and charging requirements to quite common Lead acid or Lead gel type. Never use a Lead type charger to charge it.



**To ensure best long-term use of the battery, please observe the following safety rules at all times.**

- Connection dock must be handled with care to avoid damage.
- Charge the battery only with the approved charger.
- Never use a charger for lead acid type batteries on the eFOLDi battery.
- Never place the battery near, on or against any heat source.
- Ensure no metal parts can touch (or 'short') battery or charger terminals, connectors, pins or any other electrical conductor(s) or conducting parts.
- Avoid excessive physical impact and vibration of the battery.
- Do not attempt to dismantle, dissect or deform the battery(ies) or case(s).

- Do not immerse the battery in any liquid (including water).
- Keep the battery out of reach of children.
- Do not use modified or damaged chargers.
- Do not leave the battery on charge for more than 24 hours.
- Store the battery in a cool, dry, well ventilated area.
- Dispose of the battery only in accordance with local laws and regulations.
- If battery is not used often, it is preferable to give it a short 'top up' charge every 2-3 months.
- Never store the battery when it is significantly discharged.

## Battery level indicator:

The battery level indicator is positioned on the handle bar and shows how much battery there is left for usage.

### Meaning of light indication on battery:

- **Green, Orange and Red** : Battery is fully charged.
- **Orange and Red** : A medium level of battery is available.
- **Red**: Battery will soon need charging.

## Fitting the battery into the eFOLDi :

The battery is positioned in the footrest of the eFOLDi Lite. To take out and charge the battery you have to lift the release lock and it will be instantly disengaged. Repeat the process in reverse making sure the battery clicks into place. For an efficient battery removal, make sure that the main power is switched off.



## Charger and Charging

### Precaution for use and handling charger

Use only the charger originally supplied with your new eFOLDi or replacement charger supplied by SunTech UK Ltd for the use with the eFOLDi. The use of a non-approved charger will invalidate any warranty and may cause serious damage to the battery and/or your eFOLDi. The charger should not be used with or for other devices as damage caused to the charger and/or any other device by doing so will not be covered by our warranty.

It is highly recommended to ensure the charger is placed only on heat resistant surfaces and nothing which could contribute to a fire (e.g. carpet, floorboards, wood, laminate or plastic worktops and so on) - the charger will heat up during a normal charging cycle, as will the battery.

Do not leave the battery on charge for more than 24 hours, as this will reduce the life and performance of the battery.

### Charging notes for international travellers

For the benefit of international travellers, your approved eFOLDi charger can be used with any mains voltage supply from 100 to 240 Volts, with a suitable travel adaptor.

### Using the charger

After the easy removal of the battery it can be charged up by plugging into the socket.



\*Before obtaining an alternative cable, it is recommended you examine your eFOLDi charger to determine which type of plug it requires - it will be either a two -pin 'figure of 8' (IEC60320-1 C7), or a three-pin similar to a kettle (IEC60320-1 C13).



## Checks and maintenance



### Safety checks prior to using your eFOLDi.

- Check and test the brakes and make sure all the parts of the brakes are working properly.
- Check the fastening condition of each nuts, bolts and screws to make sure all the parts are properly secured and are not missing or loose.
- Check all electrical connections. Make sure they are tight and not corroded.
- Check the battery is sufficiently charged.

### Cleaning and maintenance:

Periodic cleaning of your eFOLDi will help to maintain its appearance and will both extend the life of the vehicle and improve resale value. Metal and plastic parts can be wiped with a damp cloth using a mild detergent. Use a soft lint free cloth to polish.



### **Kind reminder:**

Contact your dealer or us to have your eFOLDi regularly serviced each year.

## Technical specification

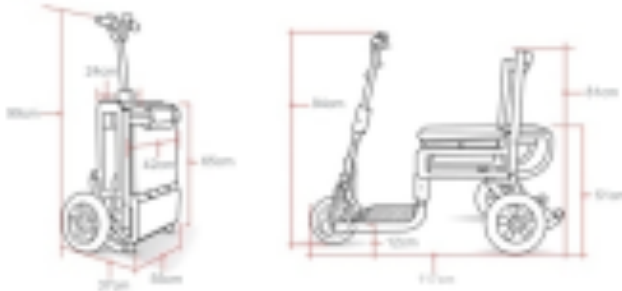

<b>Frame material:</b>	Magnesium Alloy
<b>Dimension:</b>	
<b>Packaging size (L/W/H):</b>	59x44x77cm (23x17x30inch)
<b>Folded size (L/W/H):</b>	65x55x37cm (26x22x15inch)
<b>Unfolded size (L/W/H):</b>	117x55x94cm (46x22x37inch)
<b>Seat height:</b>	51cm (20inch)
<b>Footrest height:</b>	12cm (4.7inch)
<b>Front wheel size:</b>	20cm (8inch)
<b>Rear wheel size:</b>	22.5cm (9inch)
<b>Ground clearance:</b>	7cm (2.7inch)
<b>Weight:</b>	
<b>Weight with battery:</b>	17kg (38lbs)
<b>Weight without battery:</b>	15kg (33lbs)
<b>Performance:</b>	
<b>Place to use:</b>	Pavement and indoor
<b>Speed:</b>	4mph (6kmh)
<b>Maximum carry capacity:</b>	120kg (265lbs/19st)
<b>Maximum Incline:</b>	1:10 Gradient (6 degrees)
<b>Turning radius</b>	100 (40inch)
<b>Maximum kerb height:</b>	4cm (1.5inch)
<b>Components capability:</b>	
<b>Motor:</b>	180W, 24VDC Hub motor
<b>Battery:</b>	24VDC, 10Ah Lithium Ion , 240Wh
<b>Charger:</b>	Input 110-220VAC, 50/60Hz, output 29.4V 2A
<b>Full charge range capacity:</b>	10miles (16km)
<b>Brake:</b>	Electric magnetic
<b>Main Switch:</b>	Push button
<b>Lights:</b>	No
<b>Number of Wheels:</b>	3

**Table 3: Specification-Scooter-Lite**

## Appendix



**SunTech UK Ltd**

25 Ormside Way, Holmethrope Industrial Estate, Redhill, Surrey,  
RH1 2LW

TEL: +44 (0) 2031435168



**MedPath GmbH**

Mies-van-der-Rohe-Strasse 8, 80807 Munich, Germany

### Symbols used on the label

	European CE Marking		Manufacturer
	Authorized representative in the European community		Medical device
	Serial number		Unique Device Identification
	Date of manufacture		Refer to instructions manual
	No trash bin		UK Conformity Assessed



(eFOLDi accessories)  
[www.efoldi.com/shop](http://www.efoldi.com/shop)



SunTech UK Ltd  
25 Ormside Way, Redhill,  
Surrey, RH1 2LW, UK



MedPath GmbH  
Mies-van-der-Rohe-Strasse 8  
80807 Munich, Germany



Official website address: [www.efoldi.com](http://www.efoldi.com)  
Service email: [services@efoldi.com](mailto:services@efoldi.com)  
Facebook: [www.facebook.com/efoldi.co.uk](http://www.facebook.com/efoldi.co.uk)