

PLM-180.1X

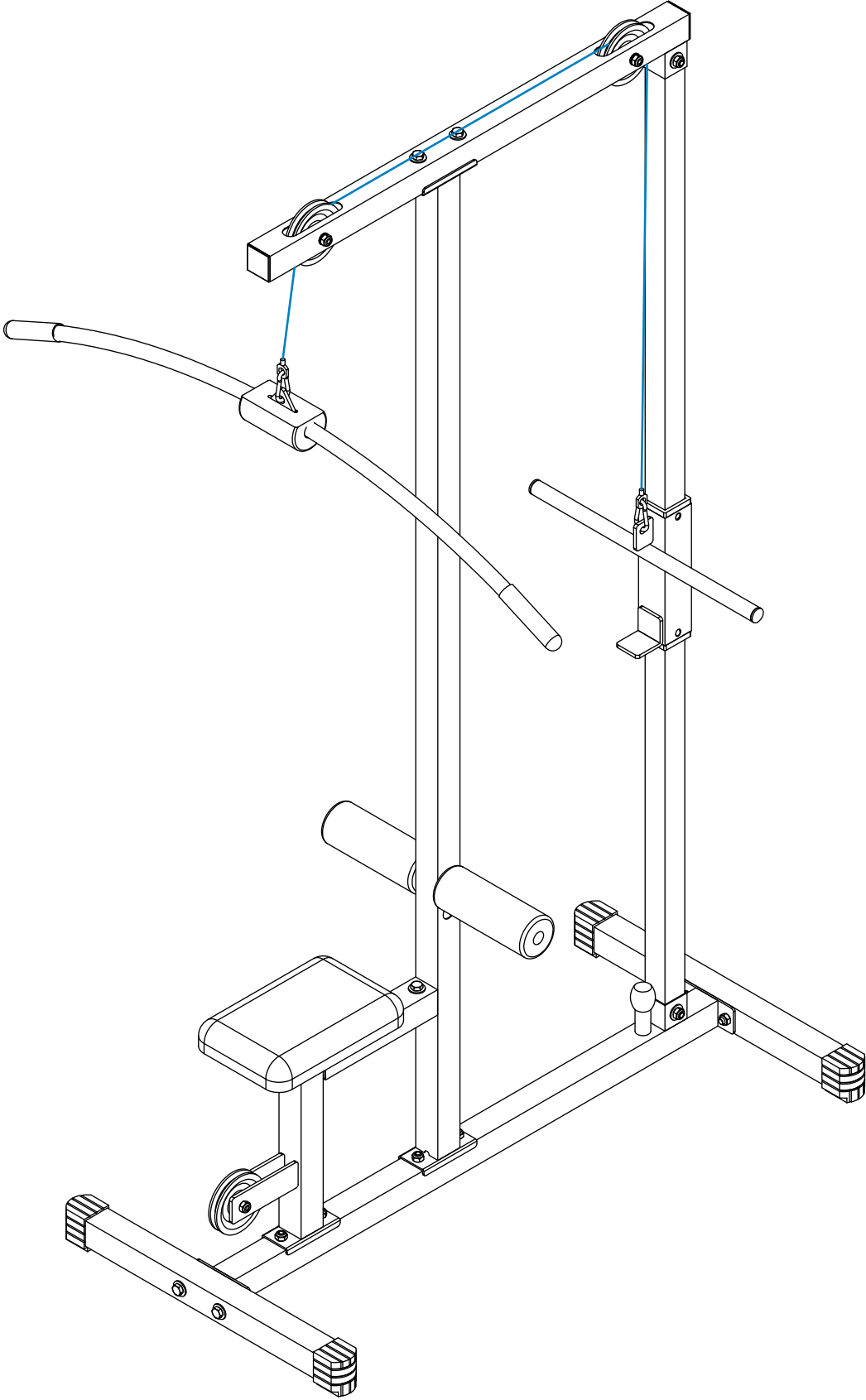

PLM-180.1X HARDWARE ILLUSTRATION SHEET

	Qty.
A1. M10X70 HEX HEAD BOLT	[6PCS]
A2. M10X70 CARRIAGE BOLT	[4PCS]
A3. M10X65 HEX HEAD BOLT	[6PCS]
A4. M8X20 HEX HEAD BOLT	[2PCS]
A5. M10X45 HEX HEAD BOLT	[1PCS]
B1. M10 NYLON LOCK NUT	[17PCS]
C1. M10 (I.D) WASHER	[14PCS]
C2. M8 (I.D) WASHER	[2PCS]
C3. M8 SPRING WASHER	[2PCS]
D1. ø6 SPRING SNAP LINK (8810-002)	[3PCS]
D2. ø1"X130L RUBBER GRIP (9212-015)	[4PCS]
D3. 50X50 END CAP (9211-005)	[2PCS]
D4. ø1" WEIGHT STOP CAP (9212-019)	[1PCS]
D5. 50X50 FOOT CAP (9212-003)	[4PCS]
D6. ø16X16 STEEL BUSHING (9211-041)	[4PCS]
D7. ø1" ROUND END CAP (9211-016)	[4PCS]
D8. ø3"X8" FOAM ROLLER (9161-060)	[2PCS]
D9. ø110 PULLEY (9213-001)	[3PCS]
D10. 60X45 NYLON BUSHING (9211-032)	[2PCS]
D11. 2580mm LAT CABLE	[1PCS]
D12. 1900mm LOW ROW CABLE	[1PCS]
D13. ø3"X5" FOAM ROLLER (9161-026) preinstalled	[1PCS]

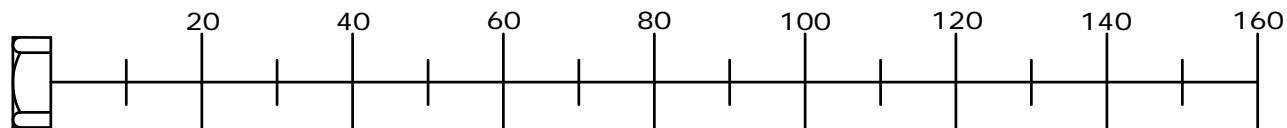
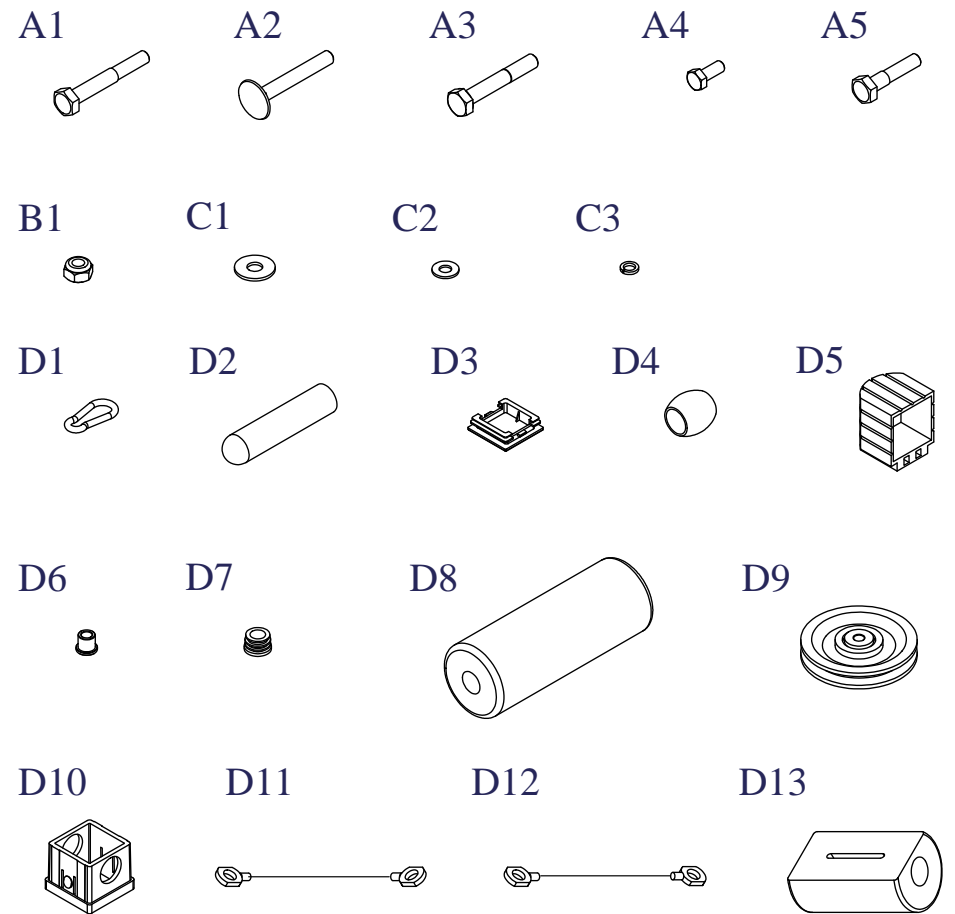

PLA - 180.1X PARTS ILLUSTRATION SHEET

A [1PCS]

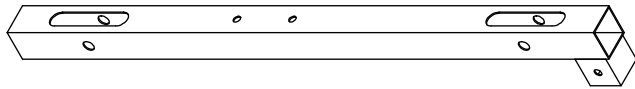

B [1PCS]

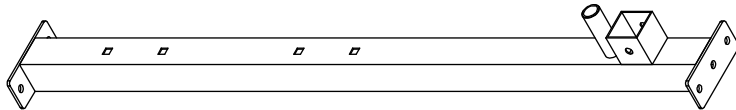

C [1PCS]

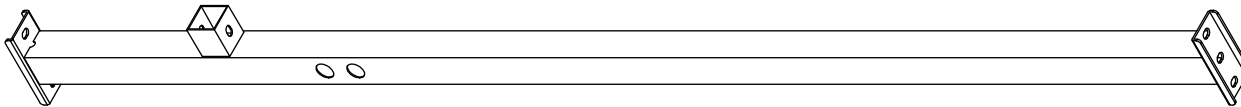

L [1PCS]



D [1PCS]

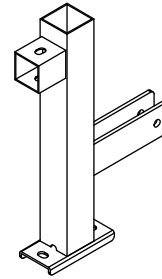

F [1PCS]

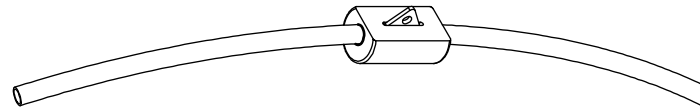

H [1PCS]

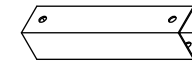

K [1PCS]

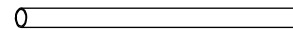

E [1PCS]

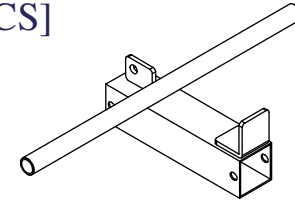

G [1PCS]



I [1PCS]

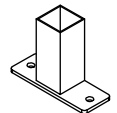

J [2PCS]

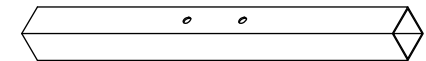

M [1PCS]

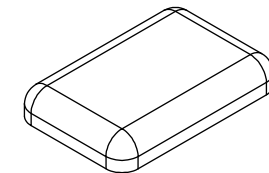

PLM-180.1X

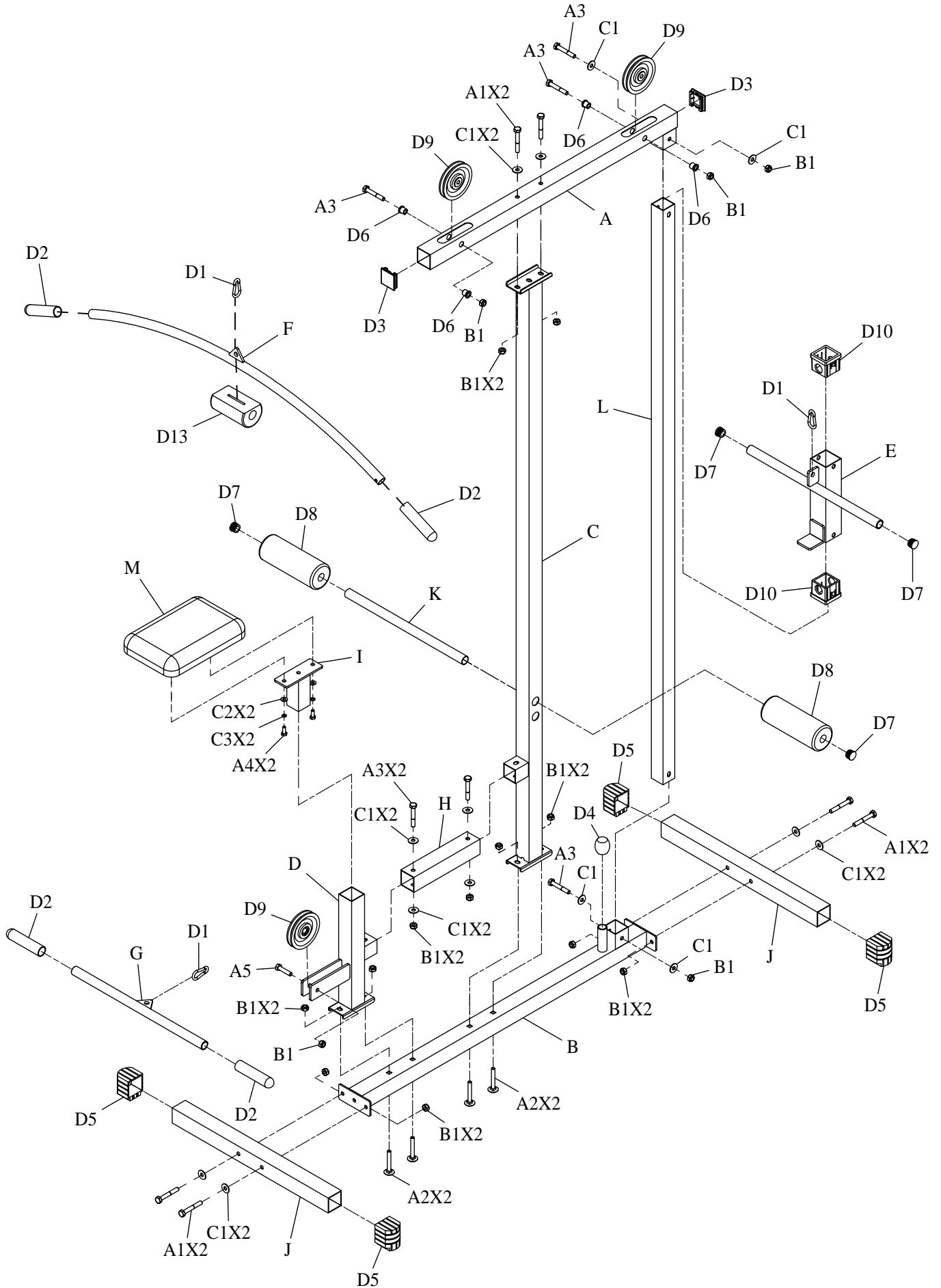

PLM-180.1X

