

SLM-300G LAT MACHINE

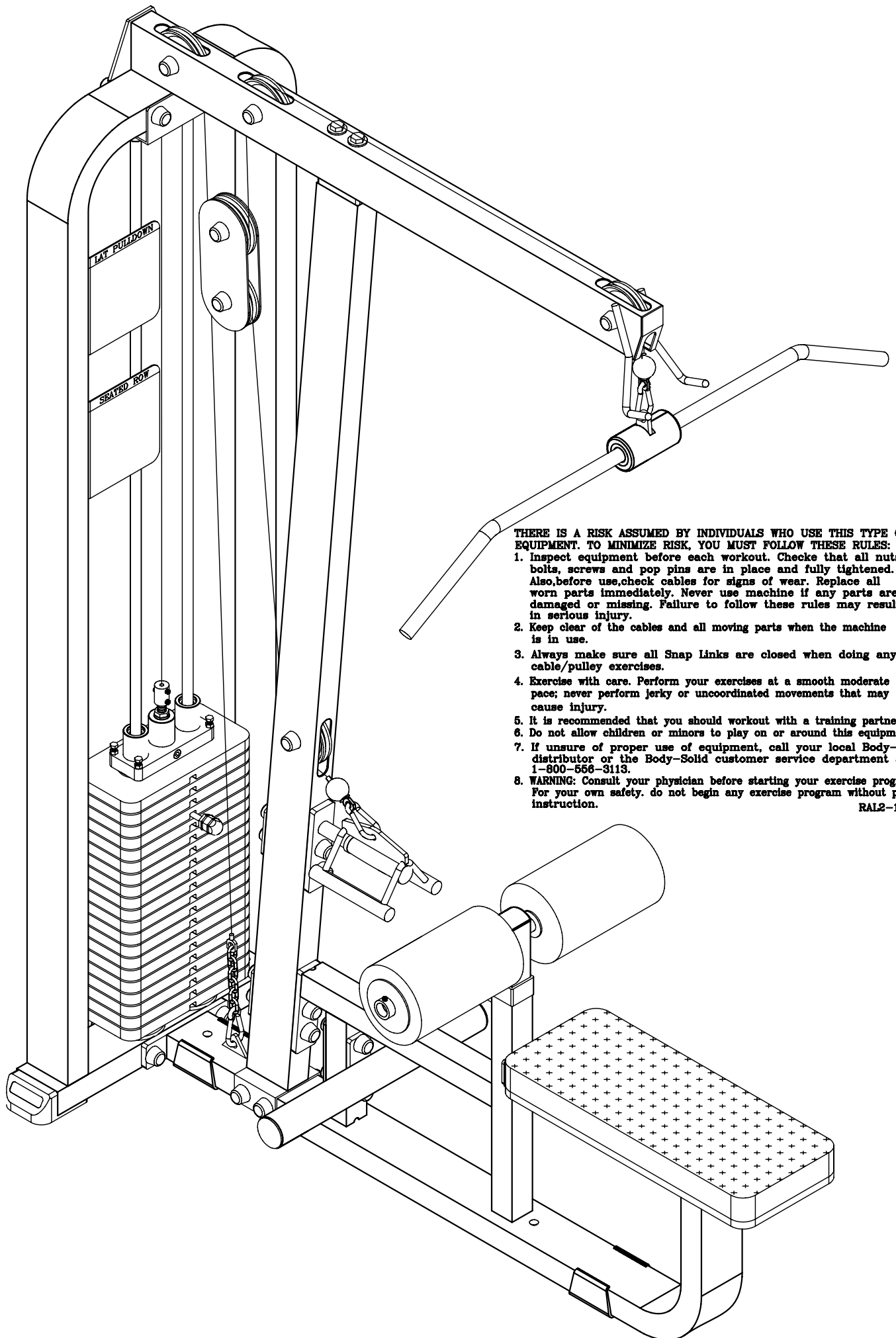











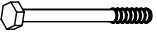
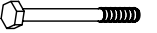
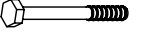









THERE IS A RISK ASSUMED BY INDIVIDUALS WHO USE THIS TYPE OF EQUIPMENT. TO MINIMIZE RISK, YOU MUST FOLLOW THESE RULES:





















1. **Inspect equipment before each workout. Check that all nuts, bolts, screws and pop pins are in place and fully tightened. Also, before use, check cables for signs of wear. Replace all worn parts immediately. Never use machine if any parts are damaged or missing. Failure to follow these rules may result in serious injury.**
2. **Keep clear of the cables and all moving parts when the machine is in use.**
3. **Always make sure all Snap Links are closed when doing any cable/pulley exercises.**
4. **Exercise with care. Perform your exercises at a smooth moderate pace; never perform jerky or uncoordinated movements that may cause injury.**
5. **It is recommended that you should workout with a training partner.**
6. **Do not allow children or minors to play on or around this equipment.**
7. **If unsure of proper use of equipment, call your local Body-Solid distributor or the Body-Solid customer service department at 1-800-556-3113.**
8. **WARNING: Consult your physician before starting your exercise program. For your own safety, do not begin any exercise program without proper instruction.**

RAL2-11-98

VERSION 200505

SLM-300G HARDWARE ILLUSTRATION SHEET

	Qty.
 A1. 1/2"X5 1/2" HEX HEAD BOLT ----[6PCS]	
 A2. 1/2"X5" HEX HEAD BOLT -----[4PCS]	
 A3. 1/2"X4 1/2" HEX HEAD BOLT ----[2PCS]	
 A4. 1/2"X3 1/4" HEX HEAD BOLT ----[2PCS]	
 A5. 3/8"X2 3/4" HEX HEAD BOLT ----[4PCS]	
 A6. 3/8"X1 3/4" HEX HEAD BOLT ----[2PCS]	
 A7. 5/16"X3" HEX HEAD BOLT -----[2PCS]	
 A8. 7/16"X1 1/2" ROUND BOLT -----[1PCS]	
 A9. 5/16"X3/8" SET SCREW -----[3PCS]	
 A10. 5/8"X1 3/4" ROUND BOLT -----[1PCS]	
 A11. 15LB BALL PIN -----[1PCS]	
 A12. ϕ 10X85L PIN -----[1PCS]	
 B1. 1/2" NYLON LOCK NUT -----[12PCS]	
 B2. 3/8" NYLON LOCK NUT -----[6PCS]	
 B3. 5/8" LOCK NUT -----[1PCS]	
 C1. 1/2" ROUND END CAP WASHER --[24PCS]	
 C2. 3/8" ROUND END CAP WASHER --[12PCS]	
 C3. 1/2" (I.D)WASHER -----[2PCS]	
 C4. 5/16" (I.D)WASHER -----[2PCS]	
 C5. 5/16" SPRING WASHER -----[2PCS]	
 C6. 5/8" SPRING WASHER -----[1PCS]	
 C7. ϕ 4" CHROME WASHER -----[2PCS]	

	Qty.
 D1. 1/2" BOLT CAP -----[36PCS]	
 D2. 2"X4" END CAP (9211-014)-----[1PCS]	
 D3. 45X45 END CAP (9211-091)-----[1PCS]	
 D4. ϕ 16X14 STEEL BUSHING (8530-003)-[8PCS]	
 D5. ϕ 8 SPRING SNAP LINK (8810-001)--[3PCS]	
 D7. 2"X4" FOOT CAP (9211-028)-----[2PCS]	
 D8. 50X45 NYLON BUSHING (9211-030)-[1PCS]	
 D9. ϕ 1"X135L RUBBER GRIP (9212-016)-[1PCS]	
 D10. ϕ 4 1/2" PULLEY (9213-010)-----[6PCS]	
 D11. ϕ 3/4" SHAFT COLLAR (9211-046)--[2PCS]	
 D12. 2"X4" RUBBER DOUNT (9212-009)--[2PCS]	
 D13. ϕ 3" NYLON WASHER (9214-008)---[4PCS]	
 D14. NO-SLIP TAPE (9630-003)-----[2PCS]	
 D15. ϕ 4" RUBBER DONUT (9310-017)---[2PCS]	
 D16. ϕ 6"X10" FOAM ROLLER (9161-016)--[2PCS]	
 D17. CHROME TOP PLATE (8400-002)---[1PCS]	
 D18. WEIGHT SELECTOR BAR (8220-060)-[1PCS]	
 D19. 2700mm STEEL CABLE -----[1PCS]	
 D20. 3350mm STEEL CABLE -----[1PCS]	
 D21. ϕ 5/8" ROUND END CAP (9211-015) [4PCS]	
 D22. ϕ 1" SHAFT COLLAR (8130-024)----[2PCS]	

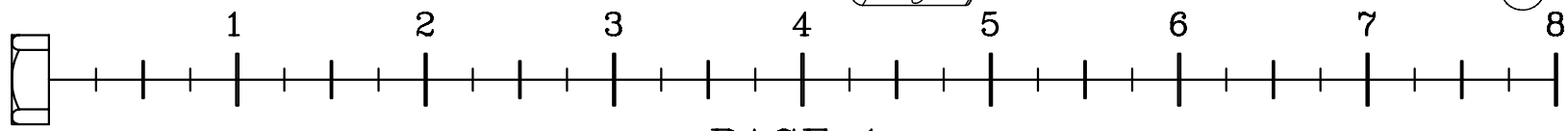
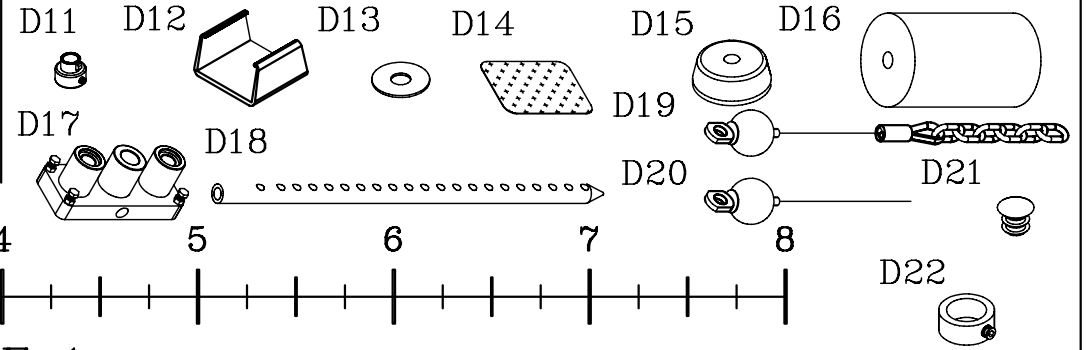

SLM-300G

PARTS ILLUSTRATION SHEET

A [1PCS] WEIGHT STACK FRAME

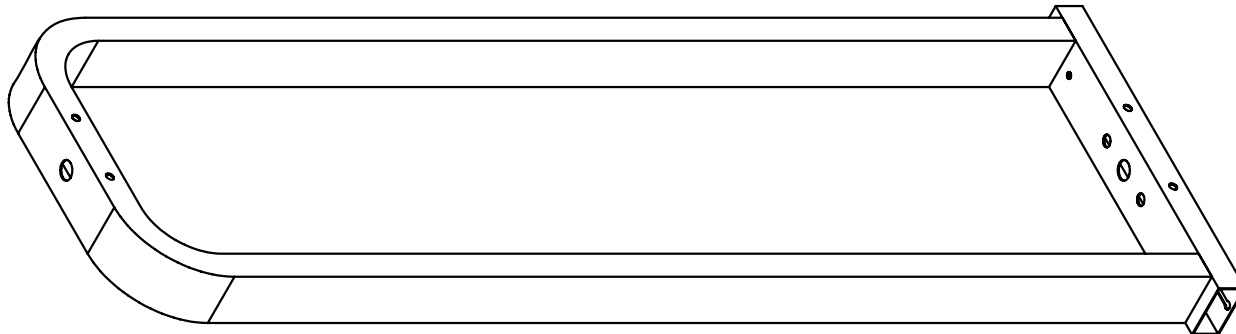

B [1PCS] MAIN BASE FRAME

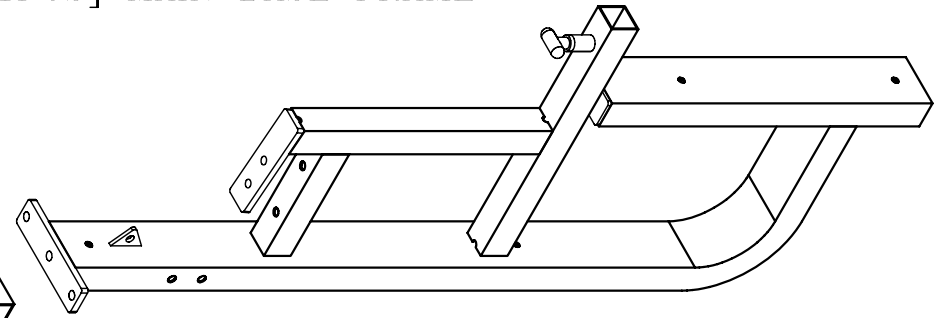

C [1PCS] VERTICAL SUPPORT FRAME

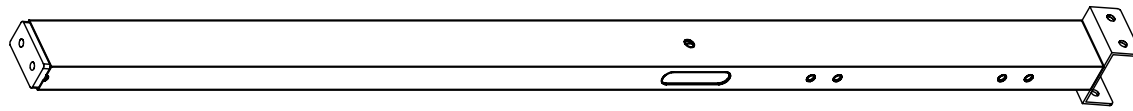

E [1PCS] HANDLE REST

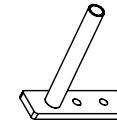

F [1PCS] LEG HOLD DOWN

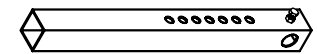

D [1PCS] TOP LAT FRAME

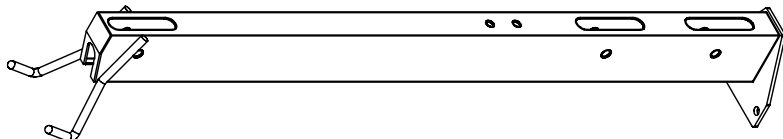

G [1PCS] FOOT TUBE

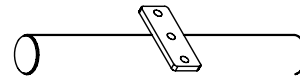

H [1PCS] GUIDE ROD BRACKET

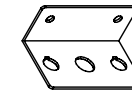

I [1PCS] TRIANGLE BAR

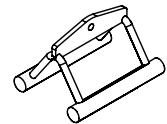

J [1PCS] LAT BAR

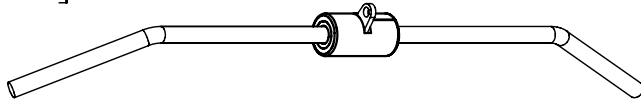

K [2PCS] CHROME GUIDE ROD

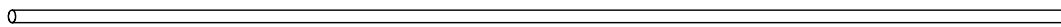

L-1 [1PCS] FOOT ROLLER BAR (ø1"X610mm)

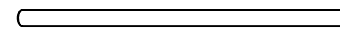

M [2PCS] 2"X4" PLATE



N [1PCS] 2"X6" PLATE

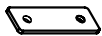

O [1PCS] 2"X8" PLATE

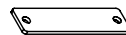

P [2PCS] PULLEY PLATE



Q [1PCS] SEAT PAD

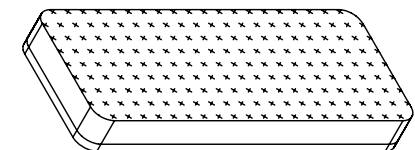

SLM-300G

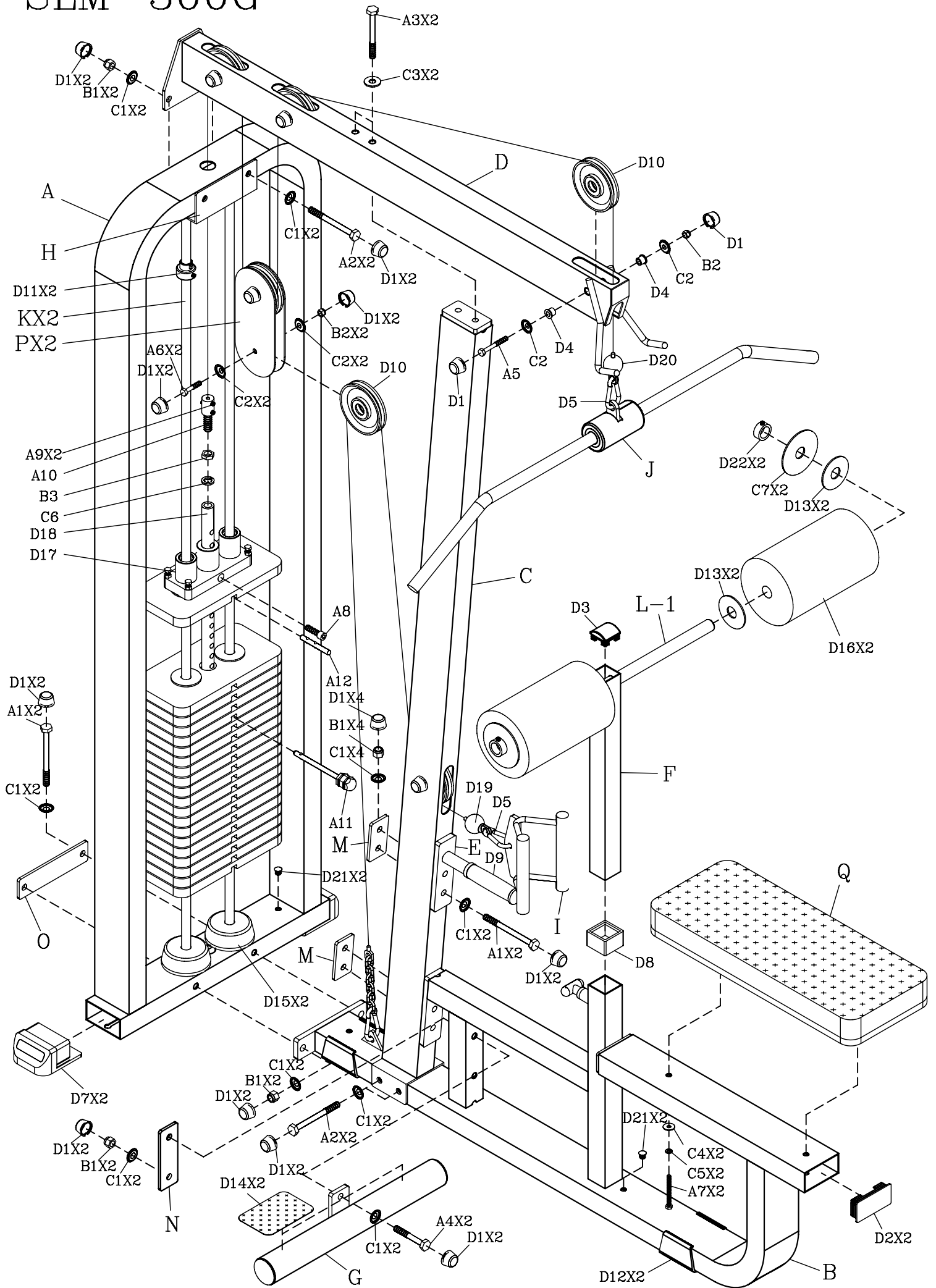

SLM-300G LAT MACHINE

ASSEMBLY STEPS

STEP-1

NOTE: DO NOT TIGHTEN NUTS AND BOLTS SECURELY UNTIL YOU HAVE COMPLETED ALL ASSEMBLY STEPS.

- Attach A Weight Stack Frame to B Main Base Frame.
- Attach C Vertical Support Frame to B Main Base Frame.
- Attach K Chrome Guide Rods and D15 Rubber Donuts to A Weight Stack Frame.
- Slide Weight Stack Plates and D17 Chrome Top Plate onto K Chrome Guide Rods.

STEP-2

- Attach H Guide Rod Bracket and D Top Lat Frame to A Weight Stack Frame and C Vertical Support Frame and attach D11 Shaft Collar.
- Slide F Leg Hold Down into B Main Base Frame.
- Slide L Foot Roller Bar into F Leg Hold Down.
- Attach E Handle Rest to C Vertical Support Frame.
- Attach G Foot Tube to B Main Base Frame.

**CAUTION: DO NOT OVERTIGHTEN PAD BOLTS.
OVERTIGHTENING WILL STRIP
T-NUTS IN THE WOOD.**

STEP-3

- Attach Q Seat Pad to B Main Base Frame.
- Attach D16 Foam Rollers to L Foot Roller Bar.
- Attach Pulleys and Cables as shown.
- Attach End Caps, Grips and Numbers.
- TIGHTEN ALL NUTS AND BOLTS SECURELY.
- Attach Bolt Caps.

SAFETY RULES

1. Periodically check that all nuts, bolts and screws are fully tightened on your LAT MACHINE.
2. Exercise with care. Perform your exercises at a smooth moderate pace; never perform jerky or uncoordinated movements that may cause injury.
3. It is recommended that you should workout with a training partner.
4. Warning: CONSULT YOUR PHYSICIAN BEFORE STARTING YOUR EXERCISE PROGRAM. IT IS ADVISABLE TO HAVE A PHYSICAL EXAMINATION BEFORE YOU ENTER ANY EXERCISE PROGRAM. FOR YOUR OWN SAFETY, DO NOT BEGIN ANY EXERCISE WITHOUT PROPER INSTRUCTION.

SLM-300G LAT MACHINE

