

PPR-200

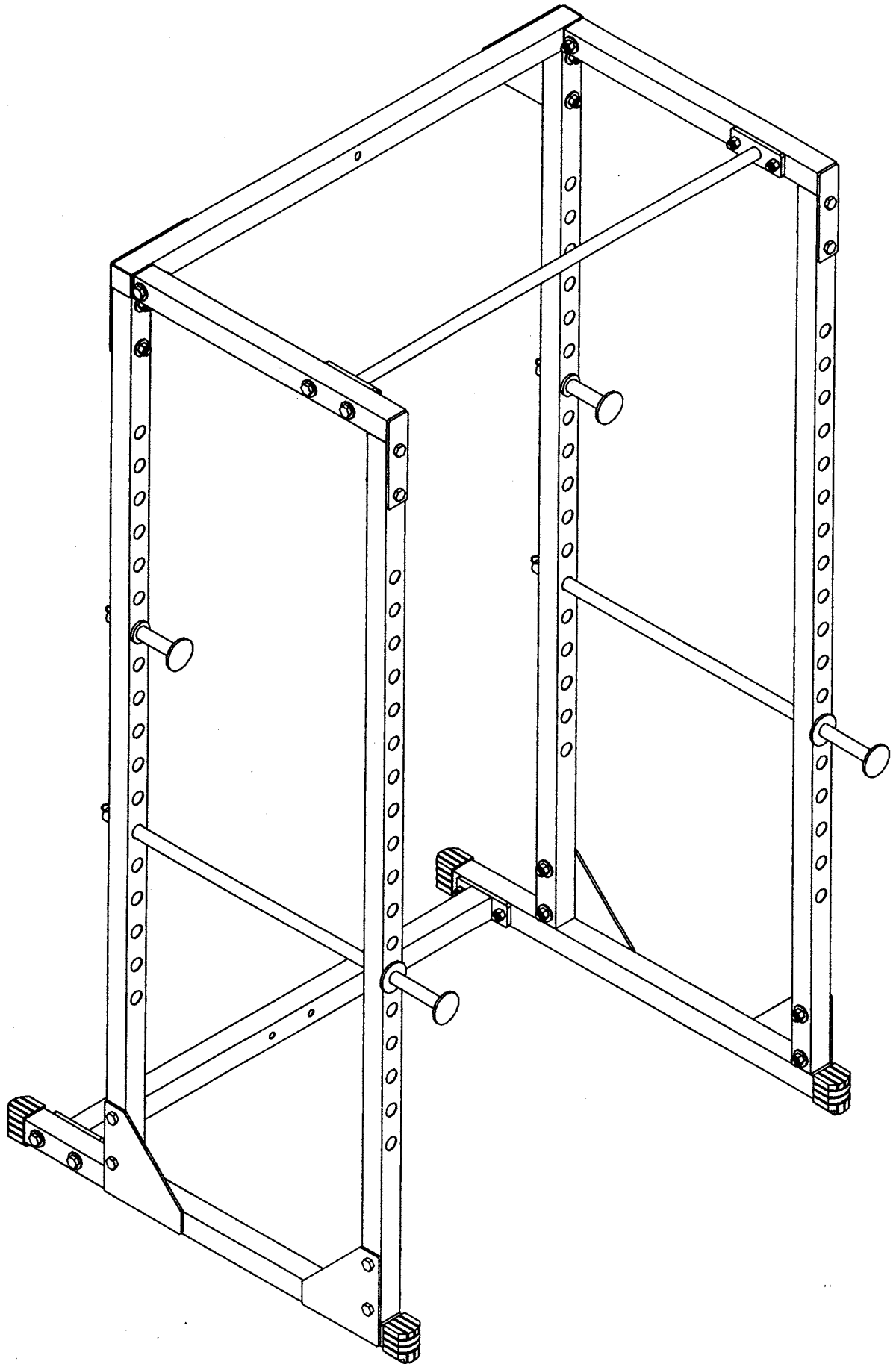

VERSION 0506

HARDWARE ILLUSTRATION SHEET

PARTS ILLUSTRATION SHEET

- Qty.
- A1. M10X75 HEX HEAD BOLT [4PCS]
 - A2. M10X70 HEX HEAD BOLT [20PCS]
 - A3. M10X65 HEX HEAD BOLT [2PCS]
 - B1. M10 NYLON LOCK NUT [26PCS]
 - C1. M10 (I.D) WASHER [28PCS]
 - D1. Ø10X35mm PIN (8250-014) [4PCS]
 - D2. 2"X2" FOOT CAP (9212-003) [4PCS]
 - D3. 2"X2" END CAP (9211-005) [2PCS]

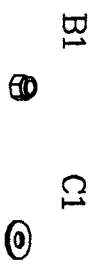

A [4PCS]

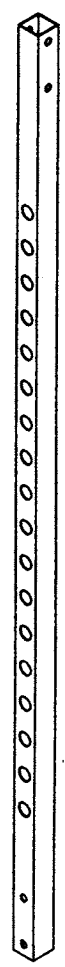

B [1PCS]

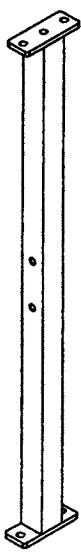

C [1PCS]

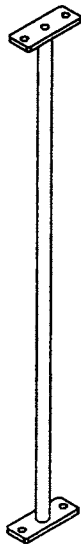

D [2PCS]



E [2PCS]



F [2PCS]

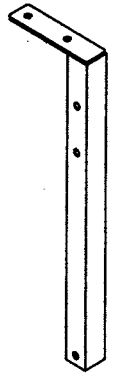

G [1PCS]

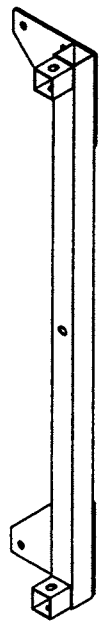

H [1PCS]

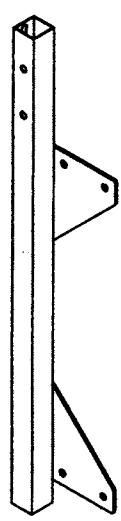

I [1PCS]

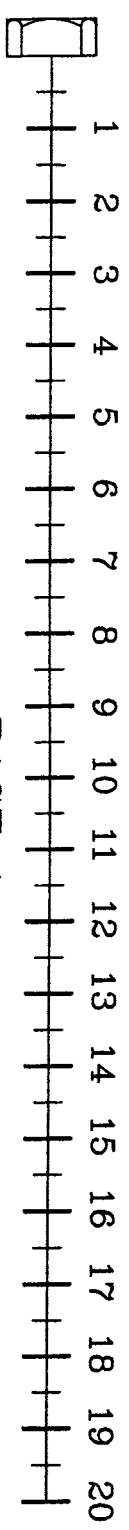
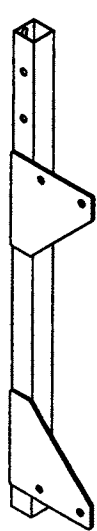

PPR-200

