

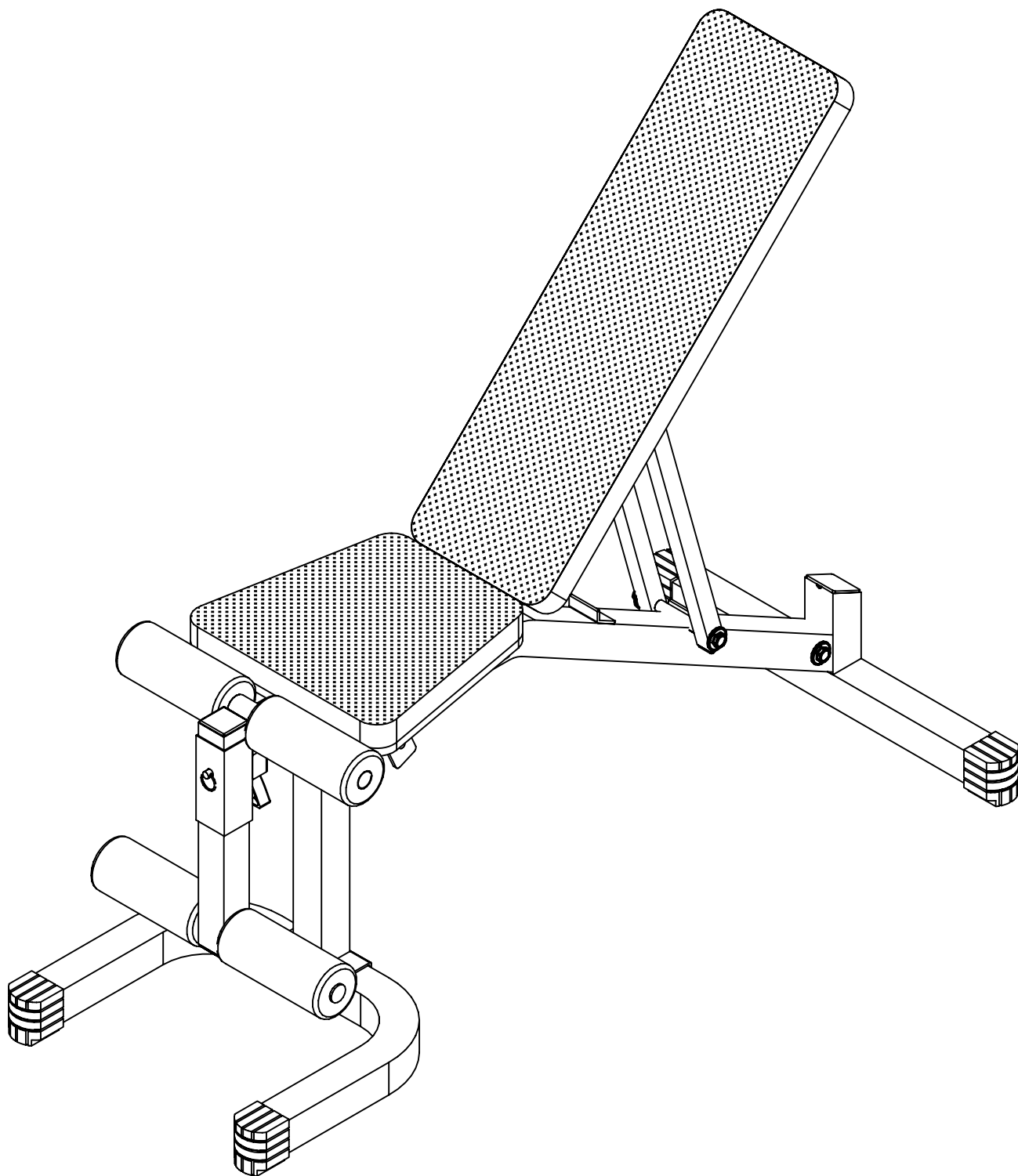









PFID-130.2











VERSION 0302

A1.	M8X20L HEX HEAD BOLT	[6PCS]	Qty.
A2.	M8X45L HEX HEAD BOLT	[1PCS]	
A3.	M10X65L HEX HEAD BOLT	[1PCS]	
A4.	M10X70L HEX HEAD BOLT	[2PCS]	
A5.	M10X80L HEX HEAD BOLT	[2PCS]	
A6.	M10X145L HEX HEAD BOLT	[2PCS]	
B1.	M10 NYLON LOCK NUT	[7PCS]	
C1.	M8 SPRING WASHER	[7PCS]	
C2.	M8 (I.D)WASHER	[7PCS]	
C3.	M10 (I.D)WASHER	[14PCS]	

D1.	QUICK RELEASE RING PIN (8250-015)	[1PCS]	Qty.
D2.	QUICK RELEASE BALL PIN (8250-016)	[1PCS]	
D3.	1"X1" END CAP (9211-001)	[4PCS]	
D4.	45X45 END CAP (9211-004)	[2PCS]	
D5.	2"X2" END CAP (9211-005)	[1PCS]	
D6.	1"X2" END CAP (9211-009)	[1PCS]	
D7.	ROUND END CAP (9211-016)	[4PCS]	
D8.	2"X2" FOOT CAP (9212-003)	[4PCS]	

A1	A2	A3	A4	A5	A6
					
B1	C1	C2	C3		
					

D1	D2	D3	D4
			
D5	D6	D7	D8
			

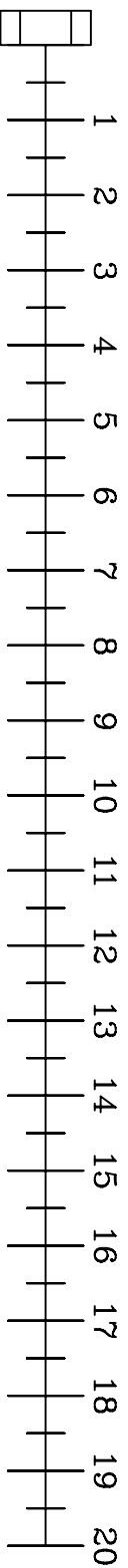

A [1PCS]

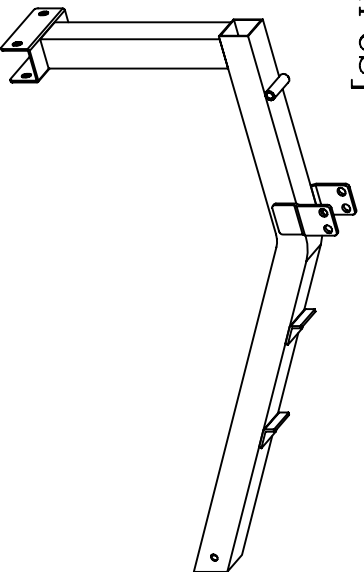

F [1PCS]

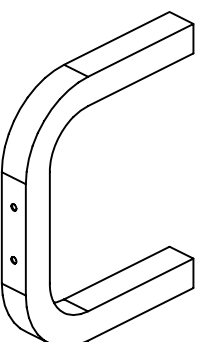

G [2PCS]

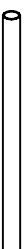

H [1PCS]



B [1PCS]

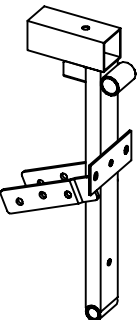

I [1PCS]

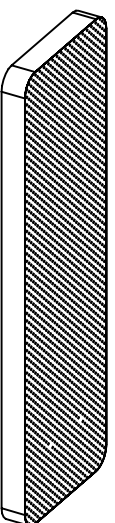

J [1PCS]

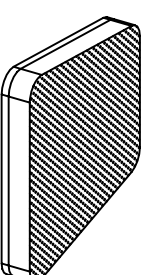

C [1PCS]

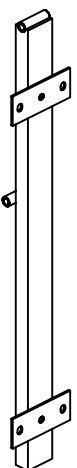

K [4PCS]



L [1PCS]



D [1PCS]

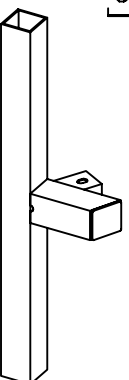

E [2PCS]



PFID-130.2

