

GRCH-322

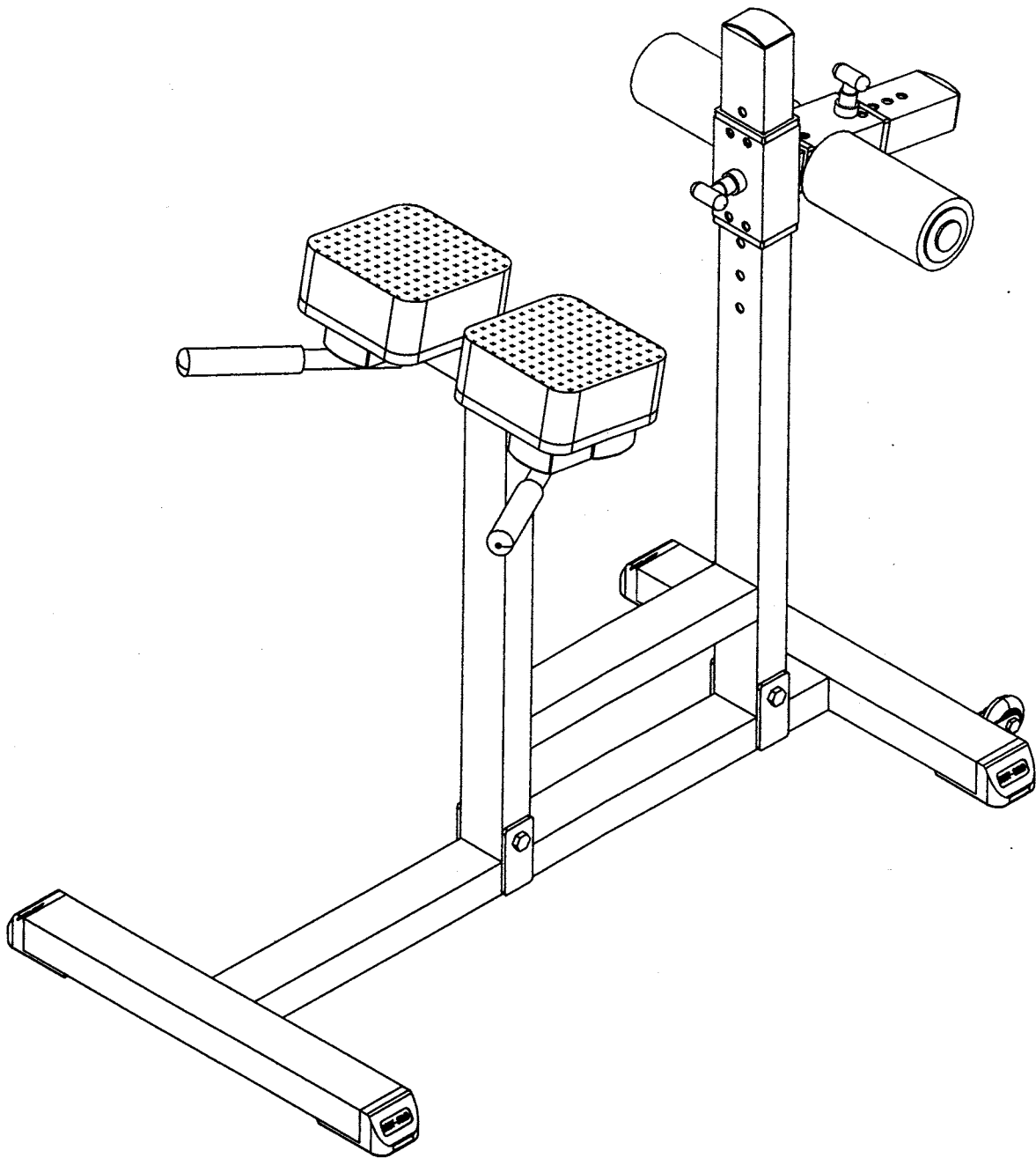

VERSION 0506

GRCH-322 HARDWARE ILLUSTRATION SHEET

A1.	M12X100 HEX HEAD BOLT	[2PCS]
A2.	M10X20 HEX HEAD BOLT	[4PCS]
A3.	5/16"X2 3/4" HEX HEAD BOLT	[4PCS]
A4.	M8X45 HEX HEAD BOLT	[2PCS]
B1.	M12 NYLON LOCK NUT	[2PCS]
B2.	M8 NYLON LOCK NUT	[2PCS]
C1.	M10 (I.D) WASHER	[4PCS]
C2.	5/16" (I.D) WASHER	[4PCS]
C3.	5/16" SPRING WASHER	[4PCS]
C4.	M8 (I.D) WASHER	[4PCS]
D1.	50X75 NYLON BUSHING (9212-031)	[4PCS]
D2.	50X75 END CAP (9211-084)	[6PCS]
D3.	50X75 FOOT CAP (9211-025)	[4PCS]
D5.	ø4"X8 FOAM ROLLER (9161-009)	[2PCS]
D6.	ø75 NYLON WASHER (9214-008)	[2PCS]
D7.	ø1" ROUND END CAP (8341-033)	[2PCS]
D8.	ø1" ROUND END CAP (9260-021)	[2PCS]
D9.	150X250 NO-SLIP TAPE (9310-036)	[1PCS]
D10.	ø64 PULLEY (9213-023)	[2PCS]

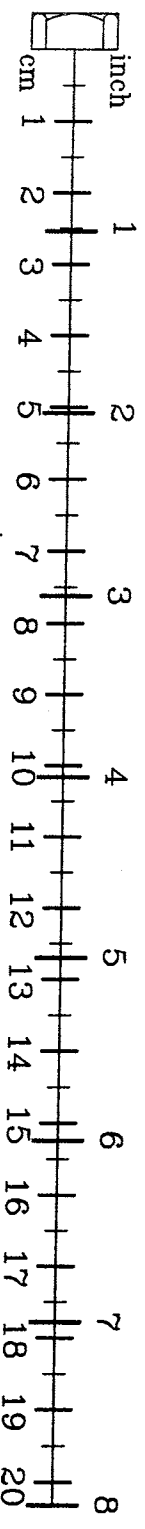
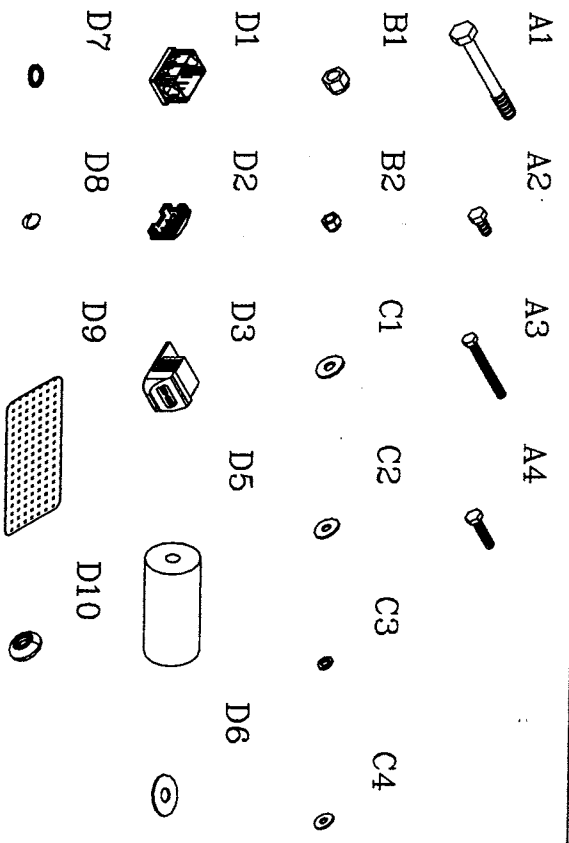

GRCH-322 PARTS ILLUSTRATION SHEET

A [1PCS]

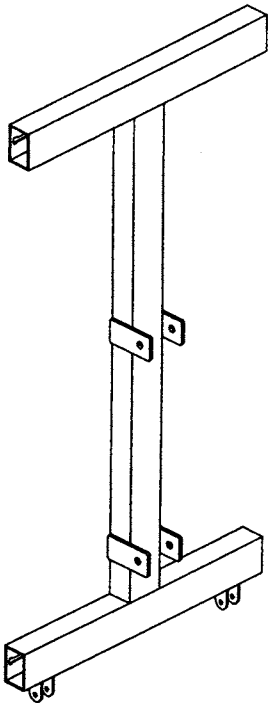

B [1PCS]

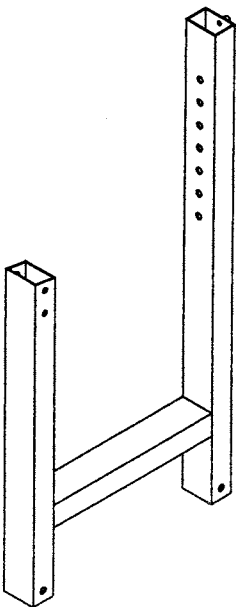

C [1PCS]

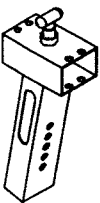

D [1PCS]



E [1PCS]

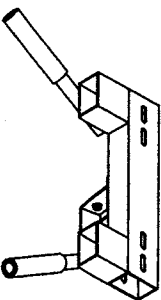

G [1PCS]



F [1PCS] Left

9132-011

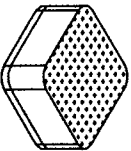

H [1PCS] Right

9132-012

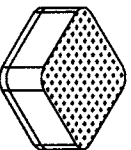

GRCH-322

THERE IS A RISK ASSUMED BY INDIVIDUALS WHO USE THIS TYPE OF EQUIPMENT. TO MINIMIZE RISK, YOU MUST FOLLOW THESE RULES:

1. Inspect equipment before each workout. Check that all nuts, bolts, screws and pop pins are in place and fully tightened. Also, before use, check cables for signs of wear. Replace all worn parts immediately. Never use machine if any parts are damaged or missing. Failure to follow these rules may result in serious injury.
2. Keep clear of the cables and all moving parts when the machine is in use.
3. Always make sure all Snap Links are closed when doing any cable/pulley exercises.
4. Exercise with care. Perform your exercises at a smooth moderate pace; never perform jerky or uncoordinated movements that may cause injury.
5. It is recommended that you should workout with a training partner.
6. Do not allow children or minors to play on or around this equipment.
7. If unsure of proper use of equipment, call your local Body-Solid distributor or the Body-Solid customer service department at 1-800-556-3113.
8. **WARNING:** Consult your physician before starting your exercise program. For your own safety, do not begin any exercise program without proper instruction.

RAL2-11-98

