

GLRA-81

LAT/ROW ATTACHMENT

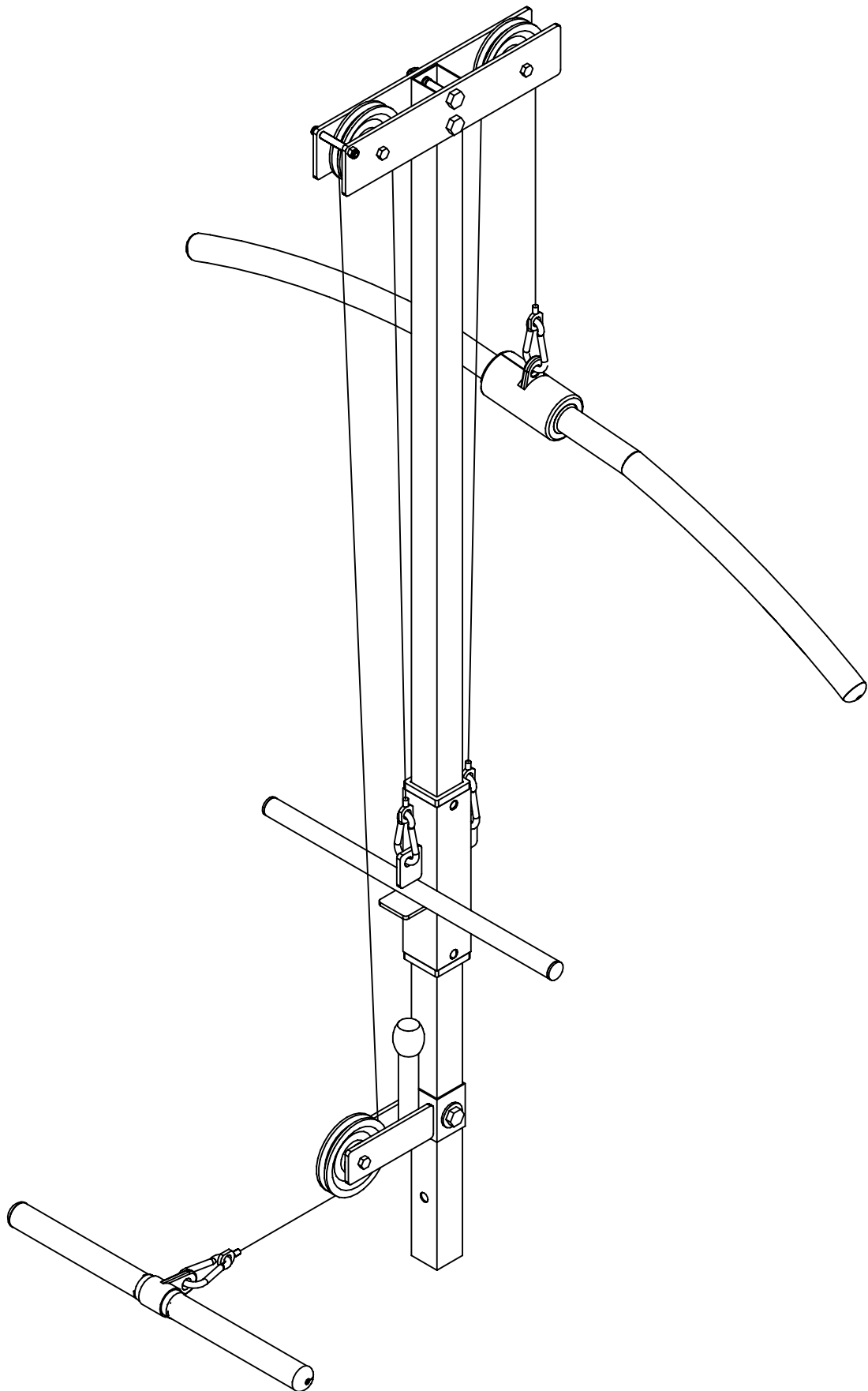





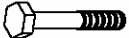
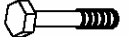
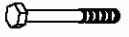
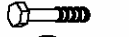

VERSION 0511

# GLRA-81

## HARDWARE ILLUSTRATION SHEET

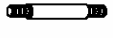
## PARTS ILLUSTRATION SHEET

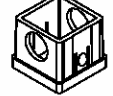
		Qty.
	A1. M12X75 HEX HEAD BOLT	[2PCS]
	A2. M12X70 HEX HEAD BOLT	[1PCS]
	A3. M10X75 HEX HEAD BOLT	[2PCS]
	A4. M10X50 HEX HEAD BOLT	[1PCS]
	B1. M12 NYLON LOCK NUT	[3PCS]
	B2. M10 NYLON LOCK NUT	[3PCS]
	B3. M8 NYLON LOCK NUT	[2PCS]
	C1. M12 (I.D.)WASHER	[2PCS]
D1	D1. M8X75 SHAFT BOLT (8260-003)	[1PCS]
	D2. $\phi 1$ " ROUND END CAP (9260-021)	[4PCS]
D2	D3. 60X45 NYLON BUSHING (9211-032)	[2PCS]
	D4. $\phi 1$ " ROUND END CAP (9211-016)	[2PCS]
	D5. $\phi 4 \frac{1}{4}$ "X21t PULLEY (9213-002C)	[1PCS]
D3	D7. $\phi 1$ " RUBBER CANE TIP (9212-019)	[1PCS]
	D8. $\phi 8$ SPRING SNAP LINK (8810-001)	[4PCS]
	D9. 3280mm STEEL CABLE	[1PCS]
	D10. 1550mm STEEL CABLE	[1PCS]
	D11. $\phi 4 \frac{1}{4}$ "X45t PULLEY (9213-002D)	[2PCS]

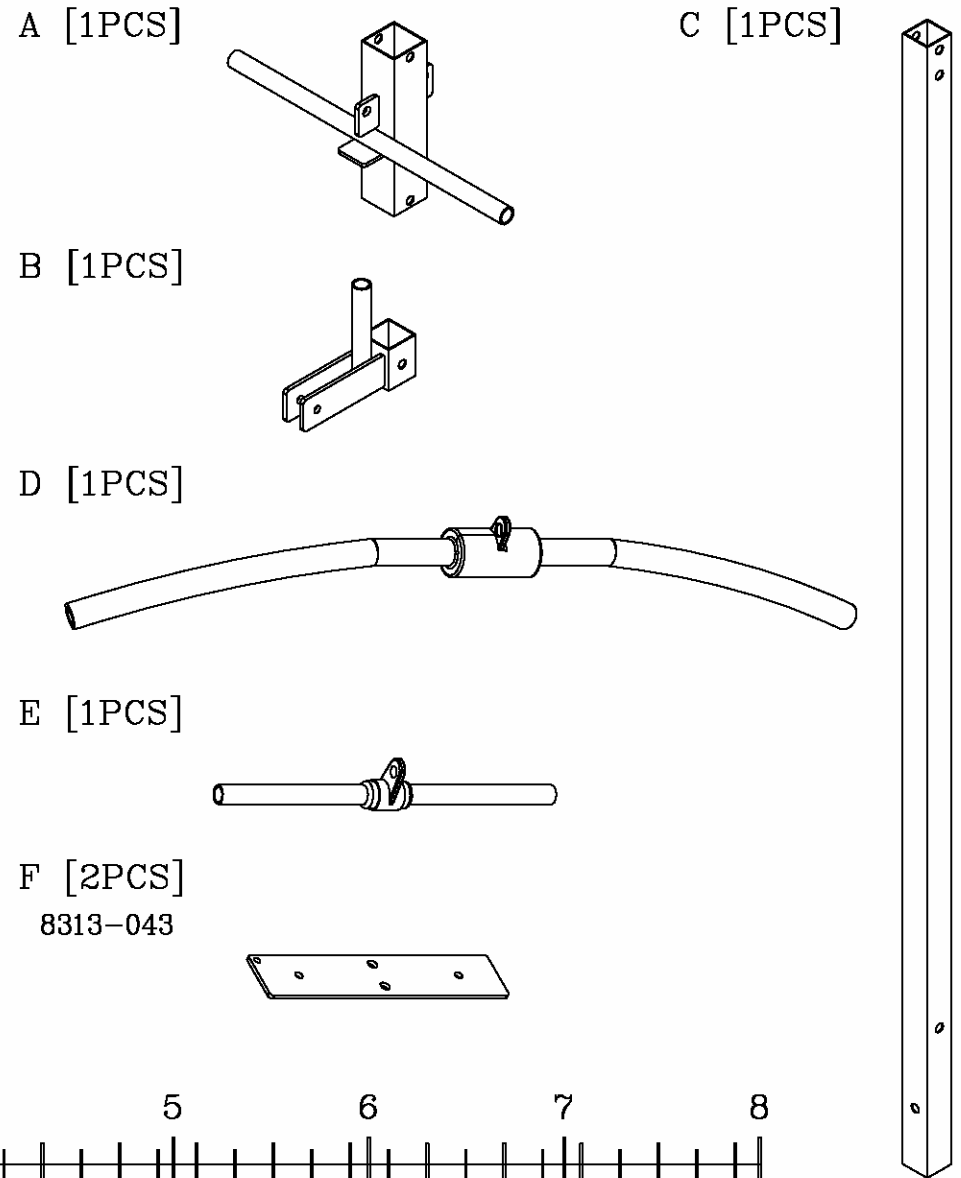
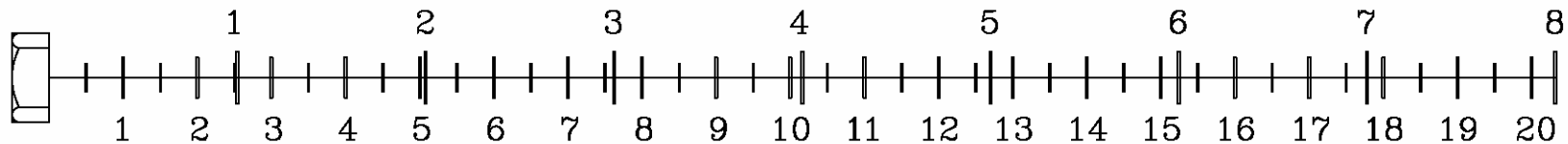

# GLRA-81

