

4-Point

4-POINT SEATBELT KIT
INSTALLATION GUIDE

TABLE OF CONTENTS

WELCOME..... 2

INSTALLATION HARDWARE..... 3

PRECAUTIONS..... 4

INSTALLATION GUIDELINES

 INSTALLATION OVERVIEW..... 6

 INSTALLATION GUIDELINES..... 7

 USE AND MAINTENANCE..... 10

LIMITED WARRANTY..... 11

INSTALLATION NOTES..... 12

Thank you for purchasing a RetroBelt® 4-point seatbelt kit. This four-point harness features an attractive chrome push-button buckle and black webbing. This is not a racing harness. It is an advanced driver or passenger restraint system designed to provide an additional level of safety over lap belts or lap and shoulder systems. The harness is fully adjustable and mounts to the existing seatbelt anchors. It includes mounting hardware to install the harness to the floor, harness bar or roll bar.

General Features

- Meet or exceed Federal Motor Vehicle Safety Standards
- Mounting hardware included
- Grade 5 hardness bolts to ensure maximum safety
- Lap portion adjustable from 0" to 18"
- Rear portion adjustable from 15" to 67"
- Attractive chrome starburst push-button buckle

The information enclosed in this manual is to be used as a guide to assist you with installation and operation of your seatbelts. This guide does not cover every installation possibility, vehicle, or aspect of the installation process.

RetroBelt USA, LLC, or its subsidiaries, assume no responsibility for any installation. This manual may be updated from time to time.

Visit our website for the latest version: www.retrobelt.com.

INSTALLATION HARDWARE

The installation hardware below is designed to cover as many vehicles as possible. If your vehicle has existing anchor points installed, you may not need all of this hardware. Feel free to contact us if you have any questions.

The retrofitting instructions in this manual are only to be used as a guide for installing anchor points in vehicles that are not already equipped with them. The installation guidelines in this manual should only be performed by a professional installer to ensure that the installation is as safe as possible.

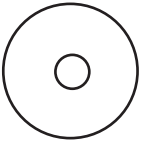

2 1/2" Oversized Washer
QTY: 4



7/16" Nut
QTY: 4



7/16" Washer
QTY: 4

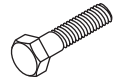

1 3/4" 7/16" Grade 5
Hex Anchor Bolt
QTY: 4



1 1/4" 7/16" Grade 5
Short Hex Anchor Bolt
QTY: 4



1" Washer
QTY: 4

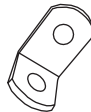

Anchor Adapter
QTY: 2



Eye Bolt
QTY: 2

This seatbelt kit has been rigorously tested by an independent laboratory to meet or exceed Federal Motor Vehicle Safety Standards (FMVSS) #209, #302.

Legal Disclosure

RetroBelt USA, LLC, or its subsidiaries assume no responsibility for proper or improper installation. Every attempt has been made to make this user's manual as informative as possible. This manual may be updated from time to time. The installation steps in this manual should only be performed by a professional installer to ensure that the installation is as safe as possible.

Warnings

Always use factory fittings added by the manufacturer whenever possible.

When using the vehicle manufacturer's threaded floor fittings, it is important that all full threads be engaged to obtain maximum strength of the anchor point.

Seatbelts should NEVER be attached to the seat unless the vehicle manufacturer specifically designed the seats and seat mounting systems to withstand seatbelt assembly loads.

When drilling, make sure you don't drill through the fuel lines, exhaust system, gas tank, brake lines, or electrical wiring.

Be certain that the area you plan to install your anchor mount to is strong enough before beginning.

Always reinforce the anchor points to ensure the safety of the driver and passengers.

Some installations may require modification to the chassis, frame, or interior to allow for safe installation of an anchor point. This should only be attempted by a professional installer.

If you are reusing existing anchor points, make sure you inspect them for cracks, rust, or other weaknesses. Do not reuse them if they are damaged in any way.

PRECAUTIONS

WARNING

Persons weighting less than 88lbs or who are less than 4'11" tall must never use this harness.

This harness will not function properly when installed with vehicles equipped with seats having no headrest or integrated headrests with no openings between the backrest and headrest. In such seats, the shoulder belts may slide off the occupant's shoulders during an accident causing serious injuries or death. Never modify factory seats to create new slots. This can weaken the seat frame or create sharp edges that can damage the seatbelt causing severe injuries or death in the event of an accident.

Figure 1

View From Front of Seat

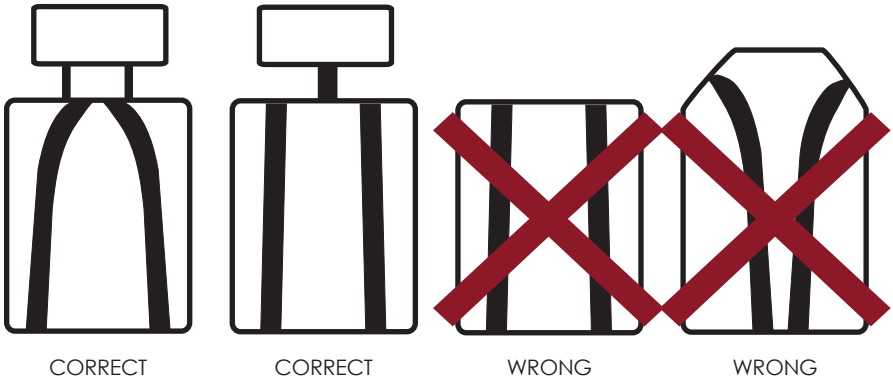

INSTALLATION GUIDELINES

Installation Overview

If your vehicle is not equipped with a 4-point system but already has a 2-point lap-belt system or a 3-point system, you can use the existing lap-belt anchor points, but you will have to add the additional anchor points. See the retrofit installation guidelines on page 7 for information on how to create the shoulder anchor points.

Figure 2

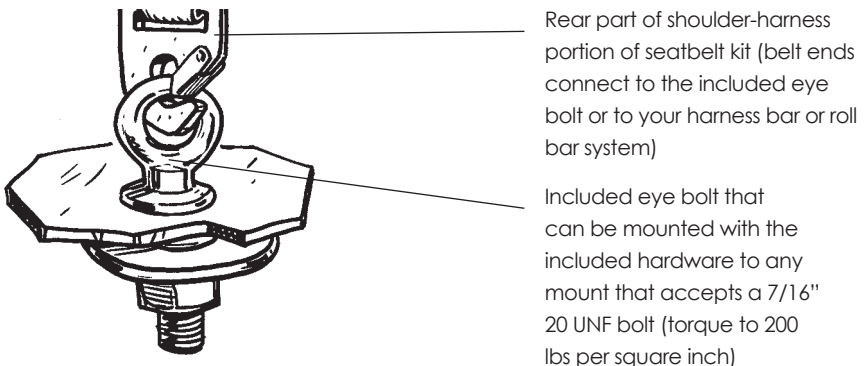
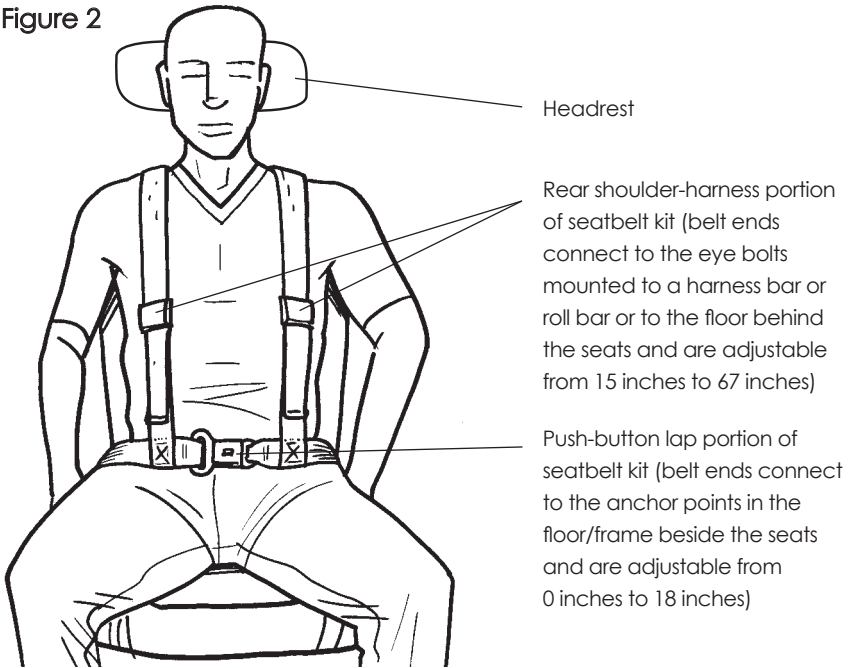

INSTALLATION GUIDELINES

Most vehicles older than 1962 will require retrofitting anchor points. Always have your seatbelts installed by an authorized professional to ensure the safety of the installation.

Installation Guidelines

1. Test fit your RetroBelt® system without installing any hardware to check for placement. Check for proper drilling clearance, and remove the seats if necessary. If factory anchor points exist, always reuse them unless they are worn or damaged.
2. Drill the holes for any anchor points you plan to install. When drilling, make sure you do not drill into the fuel lines, exhaust system, gas tank, brake lines, etc. Do not install your anchor points to any area that is weakened, rusty or damaged in any way. Always reinforce your anchor points with anchor mounts (included in your kit).
3. Install the lap-belt portion using the included anchor adapters. Make sure the path of the webbing matches the direction of the anchor point. Never bend the webbing in different direction.

Figure 3

Detailed view of lap anchor point installation

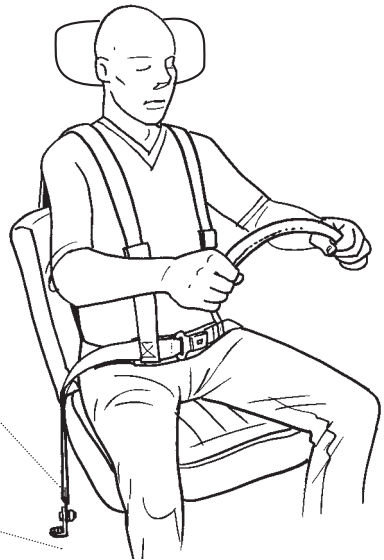
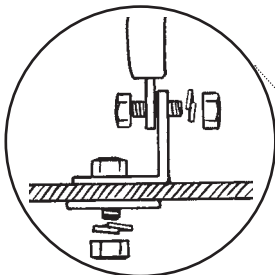

INSTALLATION GUIDELINES

4. Install the rear-shoulder portion. Always install the rear-shoulder snap-on end close to the passenger's body, but no closer than 8 inches – especially when using a harness bar or roll bar. Floor-mounted systems should never be installed in a straight-downward path, should always follow an outward-diagonal path and should always cross behind the seats.

Figure 4

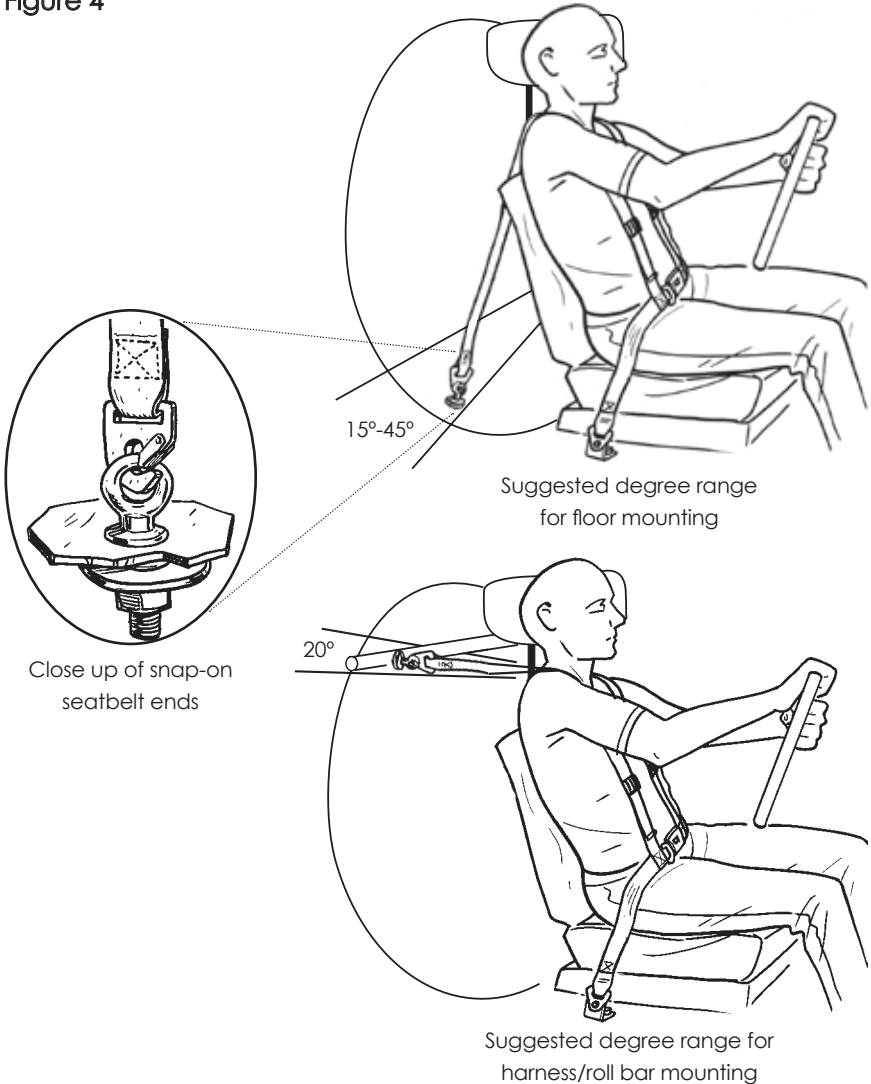

INSTALLATION GUIDELINES

Harness/Roll Bar Anchor Location

Figure 5

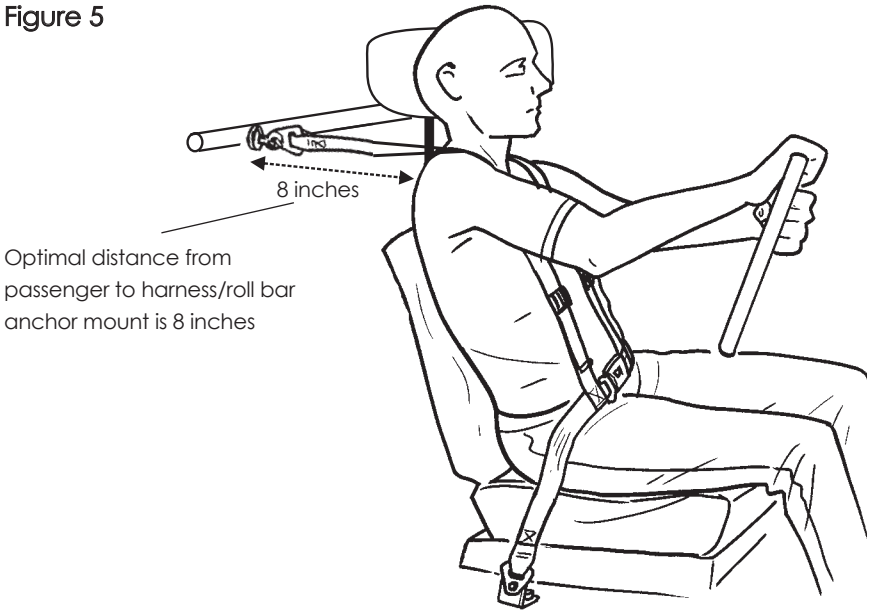

Optimal distance from passenger to harness/roll bar anchor mount is 8 inches

Floor Anchor Location

Figure 6

When using the floor-mounted anchor points, always cross the belts behind the seat to keep them in place in the event of an accident

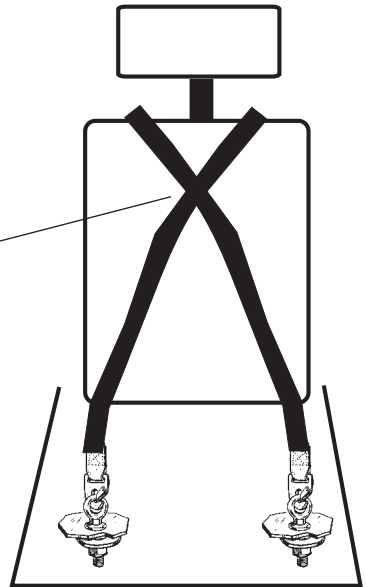

(View behind seat showing the floor anchor mounts)

USE AND MAINTENANCE

Always wear your seatbelt. If you need information on how to use your seatbelt safely, visit www.nhtsa.gov.

Adjust and wear the lap belt portion low and tight across your hips.

Each seatbelt is intended to restrain only one person at a time.

Never attempt to restrain a child in your lap by using the 4-point retractable seatbelt around both you and the child. The child could be severely injured or killed in the event of an accident. Check with your state for local laws regarding the use of seatbelts and small children.

Do not use this seatbelt or parts of this seatbelt kit with other types of seatbelts. Doing so may result in serious injury or death in the event of an accident.

WARNING: FAILURE TO PROPERLY INSTALL, USE, PERIODICALLY INSPECT AND MAINTAIN THIS SEATBELT COULD LEAD TO SERIOUS INJURY OR DEATH.

Maintenance

Inspect the seatbelt and retractor assembly regularly. If the assembly does not work properly or if the seatbelt has cuts or frayed, worn webbing, it must be replaced.

More frequent inspections may be necessary if the seatbelt is subjected to harsh treatment or extreme conditions.

Whenever a vehicle is involved in a collision you must replace every part of the seatbelt kit including the mounting hardware.

Clean seatbelts with mild soap and water. NEVER bleach or re-dye the seatbelts. Doing so will severely weaken the webbing.

Exposure to the elements will weaken the webbing on your seatbelts, reducing the effective safety feature by more than 50%. Inspect your seatbelts regularly.

Caution

Death or serious injury could result from not properly threading the webbing through the adjustable ends. Maintain a minimum of one inch of webbing beyond the anchor.

If the fixed end of a seatbelt is too long to allow a snug fit on a small occupant, do not use the belt. Children weighing less than 80 lbs should only be secured in an approved child safety or booster seat according to the manufacturer's recommendations.

LIMITED WARRANTY

Limited Warranty

If your unit does not work properly because of defects in materials and workmanship, RetroBelt USA, LLC (collectively referred to as "the warranter") will, for the length of the period indicated in the chart below, which starts with the date of original purchase ("warranty period"), replace it with a new unit. The decision to replace will be made by the warranter.

CATEGORIES	WARRANTY
4-point Seatbelt Kit	One (1) Year

During the warranty period, there will be no charge for parts. You must mail in your unit prepaid during the warranty period. This warranty only applies to products purchased and serviced in the United States. This warranty is extended only to the original purchaser of a new product which was not sold "as is." A purchase receipt or other proof of the original purchase date is required for warranty service.

To handle a warranty issue, contact us at tech@retrobelt.com or 702.483.2222 for a Return Authorization number. All returns and warranty issues must be accompanied by a Return Authorization (RA) number. Any product received without a RA number will be refused.

LIMITED WARRANTY-LIMITS AND EXCLUSIONS

This warranty ONLY covers the buckle assembly and retractor. Seatbelt webbing and associated hardware ARE NOT COVERED under warranty. This warranty ONLY COVERS failures due to defects in materials and workmanship, and DOES NOT COVER normal wear and tear or cosmetic damage. If the seatbelt has been involved in an accident, RetroBelt USA, LLC, cannot be held liable, and the seatbelt kit cannot be warranted, repaired, or returned. This warranty ALSO DOES NOT COVER damages which occurred during shipment, failures which are caused by products not supplied by the warranter, failures which result from accident, misuse, abuse, neglect, pest infestation, mishandling, misapplication, alteration, faulty installation, set-up adjustment, maladjustment of consumer control, improper maintenance, modification, commercial use or rental use of the product, or service by anyone other than RetroBelt USA, LLC, or damage that is attributable to acts of God.

THERE ARE NO EXPRESS WARRANTIES EXCEPT AS LISTED UNDER "LIMITED WARRANTY". THE WARRANTER IS NOT LIABLE FOR INCIDENTAL OR CONSEQUENTIAL DAMAGES RESULTING FROM THE USE OF THIS SYSTEM, OR ARISING OUT OF ANY BREACH OF THIS WARRANTY. (As examples, this excludes damages for lost time, cost of having someone remove or re-install an installed system if applicable, travel to and from the servicer, etc. The items listed are not exclusive, but are for illustration only.) ALL EXPRESS AND IMPLIED WARRANTIES, INCLUDING THE WARRANTY OF MERCHANTABILITY, ARE LIMITED TO THE PERIOD OF THE LIMITED WARRANTY.

Some states do not allow the exclusion or limitation of incidental or consequential damages, or limitations on how long an implied warranty lasts, so the exclusions may not apply to you. This warranty gives you specific legal rights, and you may also have other rights which vary from state to state. If a problem with this seatbelt kit develops during or after the warranty period, you may contact your dealer or RetroBelt USA, LLC.

INSTALLATION NOTES

20 horizontal dotted lines for writing.



MODERN SAFETY FOR YOUR CLASSIC