



ACEM® P9/40 GEN 2 COMPATIBILITY





















The ACEM® P9/40 GEN 2 is optimized to load the 9x19MM cartridge into GLOCK magazines. While the device is also capable of loading most other pistol magazines, the ease of use varies between make and model of magazine. The following compatibility information is a result of our own continuous testing, as well as ongoing feedback from ACEM® users. Despite the rigorous testing we perform on our products, the ultimate test is how they perform for you, our customer. Accordingly, the following information is subject to change.

CALIBER COMPATIBILITY

 <p>9X19MM</p> <p>EXCELLENT</p> <p>Smooth and consistent loading.</p>	 <p>.40 S&W</p> <p>ACCEPTABLE</p> <p>Requires more force than 9x19MM rounds.</p>	 <p>.357 SIG</p> <p>NOT RECOMMENDED</p> <p>Loading can sometimes dent the case of this necked cartridge and is not recommended for use in this device.</p>
--	---	--

MAGAZINE COMPATIBILITY

<p>EXCELLENT</p> <p>Smooth and consistent loading.</p> <ul style="list-style-type: none">  ALL  P320  ALL  ALL  ALL  MOST 	<p>LIMITED FUNCTION</p> <p>Clunky or inconsistent loading.</p> <ul style="list-style-type: none">  MOST  MOST  ALL  ALL  AMERICAN PISTOL 	<p>NOT COMPATIBLE</p> <p>Device will not load these magazines.</p> <ul style="list-style-type: none">  92FS/PX4  P229  ALL  ALL  SR9  CCP  PT709
--	---	---

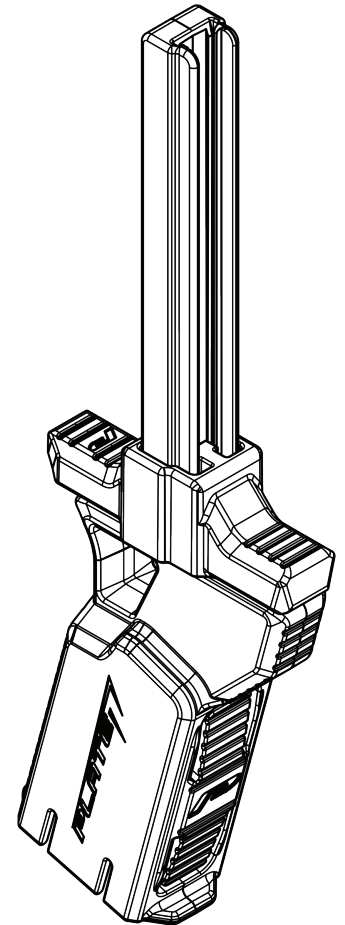

ACEM® P9/40 GEN 2

ACEM and PLATE are registered trademarks of PLATE, LLC. Beretta is a registered trademark of Fabbrica d'Armi Pietro Beretta S.p.A. CZ is a registered trademark of Česká zbrojovka a.s. FN is a registered trademark of FN HERSTAL SA. GLOCK is a registered trademark of GLOCK, Inc. HK is a registered trademark of Heckler & Koch Inc. Ruger, Ruger American Pistol, and SR9 are registered trademarks of Sturm, Ruger & Company, Inc. SCCY is a registered trademark of SCCY Industries, LLC. SIG SAUER, P320, and Z29 are registered trademarks of SIG SAUER, Inc. Smith & Wesson is a registered trademark of Smith & Wesson Corp. Springfield Armory is a registered trademark of Springfield, Inc. STI is a registered trademark of STI International, Inc. Taurus is a registered trademark of FORJAS TAURUS S.A. Walther and CCP are registered trademarks of Carl Walther GmbH.

PLATE LLC, and PLATE's products, are not affiliated with, nor endorsed by Fabbrica d'Armi Pietro Beretta S.p.A., Česká zbrojovka a.s., FN HERSTAL SA, GLOCK, Inc., Heckler & Koch Inc., Sturm, Ruger & Company, Inc., SCCY Industries, LLC., SIG SAUER, Inc., Smith & Wesson Corp., Springfield, Inc., STI International, Inc., FORJAS TAURUS S.A., or Carl Walther GmbH.

PLA021 COMPATIBILITY

REV-0 (05-06-2019)