

Instruction manual, use and maintenance

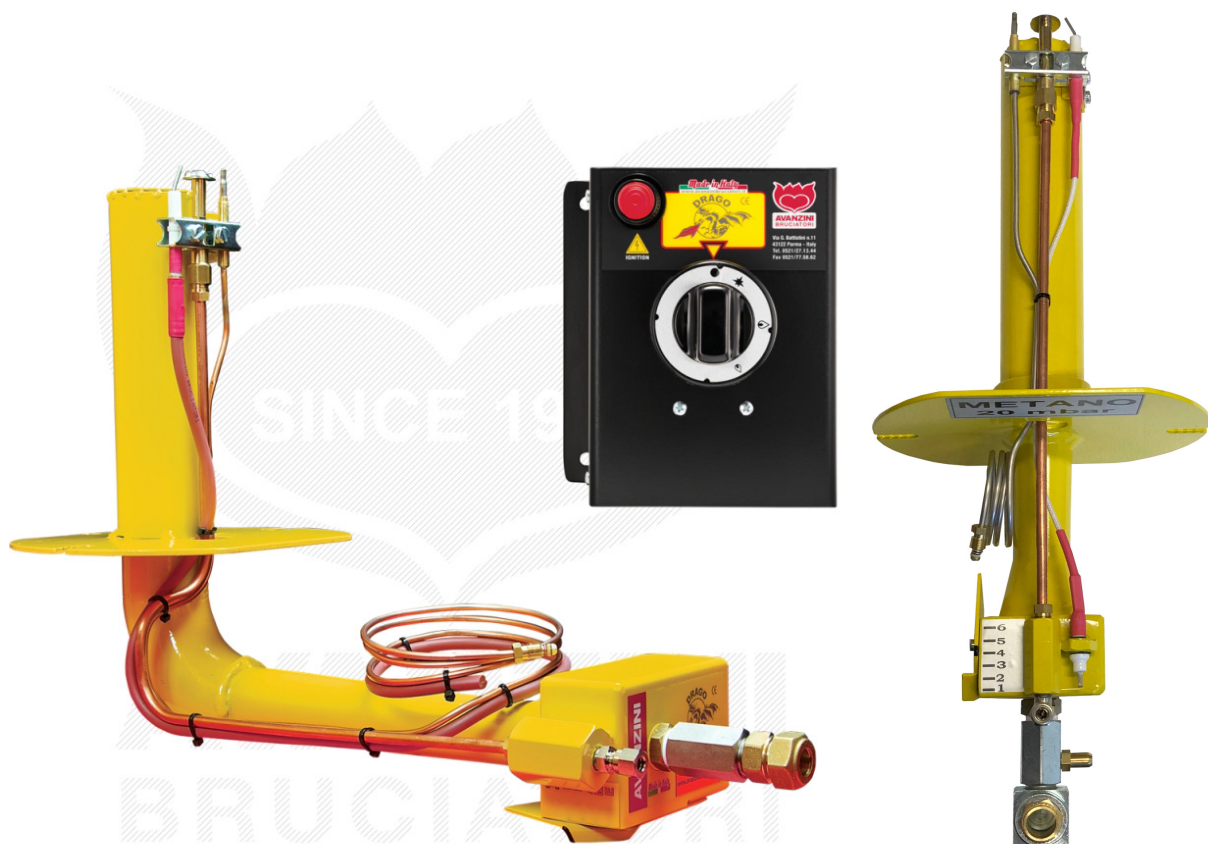

BURNER DRAGO P1

FOREWORD

All rights reserved. No part of this instruction manual can be reproduced or transmitted with any electronic or mechanical means, including photocopies, recording or any other storage and data retrieval system, for any purpose other than the exclusive personal use of the purchaser, without the express written consent of the Manufacturer.

The Manufacturer is by no means liable for the consequences of incorrect operations performed by the user.

EDITOR'S NOTE

This documentation is expressly addressed to technicians. Therefore, information that can be easily retrieved by reading these texts and analysing the drawings may not be explained further.

The Editor is by no means liable for any information and data provided in this manual: all information included herein has been supplied, controlled and approved by the Manufacturer/Agent during review.

The Editor shall by no means be held responsible for the consequences resulting from the user's misuse of the system.

GENERAL REMARKS

Any operational and maintenance instructions, as well as the recommendations described herein, shall be complied with.

To achieve the best results the Manufacturer recommends performing regular cleaning and maintenance operations so as to maintain the equipment in the best conditions.

The personnel responsible for the system must be adequately trained on its use and maintenance. They must also comply with the operating procedures and safety standards indicated in this manual.

In any case, note that the writing company is always available for any clarifications or additional information.

INDEX OF THE REVISIONS

REV.	NOTES AT PUBLICATION	No. OF LAST PAGE	DATE
00		94	07/2019
01		94	10/2022
02			
03			

COPYRIGHT

© 2022

AVANZINI BRUCIATORI s.r.l.

TABLE OF CONTENTS

TABLE OF CONTENTS

1. IDENTIFICATION OF THE MACHINE.....	9
1.1. MANUFACTURER IDENTIFICATION	9
1.2. MODEL IDENTIFICATION.....	9
1.3. IDENTIFICATION PLATE	10
1.4. DECLARATION OF CONFORMITY (COPY).....	11
1.5. REFERENCE DIRECTIVES.....	12
2. GENERAL PRELIMINARY INFORMATION.....	13
2.1. MANUFACTURER IDENTIFICATION	13
2.2. SUPPLY AND PRESERVATION.....	13
2.3. UPDATES.....	13
2.4. LANGUAGE.....	14
2.5. MANUAL PAGE STRUCTURE.....	15
2.6. OPERATOR QUALIFICATIONS	16
2.7. SYMBOLS USED IN THE MANUAL.....	18
2.8. TERMINOLOGY USED	19
2.9. SAFETY PICTOGRAMS.....	20
2.10. PERSONAL PROTECTIVE EQUIPMENT.....	21
2.11. WARRANTY	22
3. SAFETIES.....	23
3.1. SAFETY DEVICES.....	23
3.2. NOISE	24
3.3. VIBRATIONS	24
3.4. ELECTROMAGNETIC COMPATIBILITY.....	24
3.5. RESIDUAL RISKS.....	24

4. DESCRIPTION OF THE MACHINE.....	27
4.1. INTENDED USE (CORRECT).....	28
4.1.1. REASONABLY FORESEEABLE IMPROPER USE.....	28
4.2. OBLIGATIONS AND PROHIBITIONS	29
4.2.1. USER OBLIGATIONS.....	29
4.2.2. OPERATOR OBLIGATIONS.....	29
4.2.3. PROHIBITIONS FOR THE OPERATORS.....	30
4.3. TECHNICAL DATA.....	31
4.4. MAIN COMPONENTS.....	32
4.5. WORK CYCLE	34
5. TRANSPORT AND INSTALLATION	35
5.1. INTRODUCTION	35
5.2. PACKAGING.....	36
5.3. TRANSPORT AND HANDLING.....	37
5.3.1. INFORMATION ABOUT TRANSPORT AND HANDLING.....	37
5.3.2. TABLE OF UNITS AND OF WEIGHTS.....	38
5.4. ARRANGEMENTS TO BE MADE BY THE CUSTOMER.....	38
5.5. INSTALLATION ENVIRONMENT	38
5.5.1. INSTALLATION SITE.....	39
5.5.2. OVEN INSTALLED INDOORS.....	39
5.5.3. OVEN INSTALLED OUTDOORS, WITH OVEN LOADING DOOR IN A SEPARATE ROOM (INDOORS)	40
5.5.4. OVEN INSTALLED OUTDOORS.....	41
5.6. OPERATIONS ON OVEN INSTALLATIONS	42
5.6.1. HOLE IN THE COOKING TOP	42
5.6.2. POSITION FOR TEMPERATURE MEASUREMENT	43
5.6.3. HOLE FOR THE TEMPERATURE PROBE	44
5.6.4. FLUE.....	45
5.7. INSTALLING THE BURNER.....	46
5.7.1. FIXING THE FLANGE WITH SLEEVE	46
5.7.2. VERIFY POSITIONING OF THE IGNITION ELECTRODE	47

5.7.3. SECURING THE BURNER.....	48
5.7.4. SECURING THE CONTROL PANEL WITH KNOB	49
5.7.5. POSITIONING THE TEMPERATURE PROBE - OPTIONAL	50
5.8. CONNECTIONS	52
5.8.1. GAS PIPE CONNECTION FROM THE BURNER TO THE CONTROL PANEL WITH A KNOB	54
5.8.2. THERMOCOUPLE CONNECTION FROM THE BURNER TO THE CONTROL PANEL WITH A KNOB.....	56
5.8.3. COPPER PIPE (PILOT FLAME) CONNECTION FROM THE BURNER TO THE CONTROL PANEL WITH A KNOB.....	58
5.8.4. IGNITION ELECTRODE CONNECTION FROM THE CONTROL PANEL WITH A KNOB TO THE BURNER.....	60
5.9. CONNECTIONS	62
5.9.1. GAS PIPE CONNECTION FROM THE CONTROL PANEL WITH A KNOB TO THE DISTRIBUTION SYSTEM.....	65
5.10. DISMANTLING AND WASTE DISPOSAL	67
6. HOW TO USE	69
6.1. CONTROL PANEL WITH KNOB DRAGO P1	70
6.2. FIRST IGNITION AND ADJUSTMENT	71
6.2.1. FIRST IGNITION WITH THE CONTROLS OF THE CONTROL PANEL	72
6.2.2. HIGH FLAME ADJUSTMENT	73
6.2.3. LOW FLAME ADJUSTMENT	75
6.2.4. FLAME AIR ADJUSTMENT	77
6.2.5. SWITCH-OFF WHILE MAINTAINING THE PILOT FLAME	78
6.2.6. SWITCHING OFF THE BURNER.....	78
7. MAINTENANCE.....	79
7.1. INTRODUCTION	79
7.2. SAFETY WARNINGS	80
7.3. ROUTINE MAINTENANCE	81
7.3.1. ROUTINE MAINTENANCE TABLE	81
7.3.2. MACHINE CLEANING.....	82
7.4. EXTRAORDINARY MAINTENANCE.....	83
7.5. BURNER GAS CONVERSION.....	84
7.5.1. NOZZLE COMPOSITION	84
7.5.2. NOZZLE REPLACEMENT.....	85

7.5.3. PILOT FLAME AIR ADJUSTMENT	87
7.5.4. REPLACEMENT SWITCH-ON BATTERY	88
8. TROUBLESHOOTING.....	89
8.1. INTRODUCTION	89
8.2. MANUFACTURER'S ADVICE	92
9. ATTACHMENTS	93
9.1. TECHNICAL DATA SHEET	93

CONTENTS

PAGE INTENTIONALLY LEFT BLANK

1. IDENTIFICATION OF THE MACHINE

1.1. MANUFACTURER IDENTIFICATION

Any request for information or assistance must be sent to:

MANUFACTURER:	AVANZINI BRUCIATORI s.r.l. Via G. Battistini, 11 43122 Parma (PR) - ITALY Tel. (+39) 0521-271344 email: info@avanzinibruciatori.it Website address: www.avanzinibruciatori.it
----------------------	--

1.2. MODEL IDENTIFICATION

MACHINE:	BURNER
MODEL:	Drago P1
SERIAL NUMBER:	
CUSTOMER:	

This manual contains confidential information and drawings, property of AVANZINI BRUCIATORI s.r.l.
 It is forbidden to even partially reproduce the manual without the written authorisation of AVANZINI BRUCIATORI s.r.l.

1.3. IDENTIFICATION PLATE

For machine identification purposes, a special identification plate was affixed to the machine; the identification data indicated on this plate must be reported to **AVANZINI BRUCIATORI s.r.l.** every time a service call is requested or when ordering spare parts:

POS.	ELEMENT
1	Model
2	Serial number
3	Type of gas
4	Year of manufacture
5	Gas category
6	Countries
7	Gas pressure
8	Power supply
9	Electrical power
10	Thermal power
11	CE marking
12	Manufacturer Data

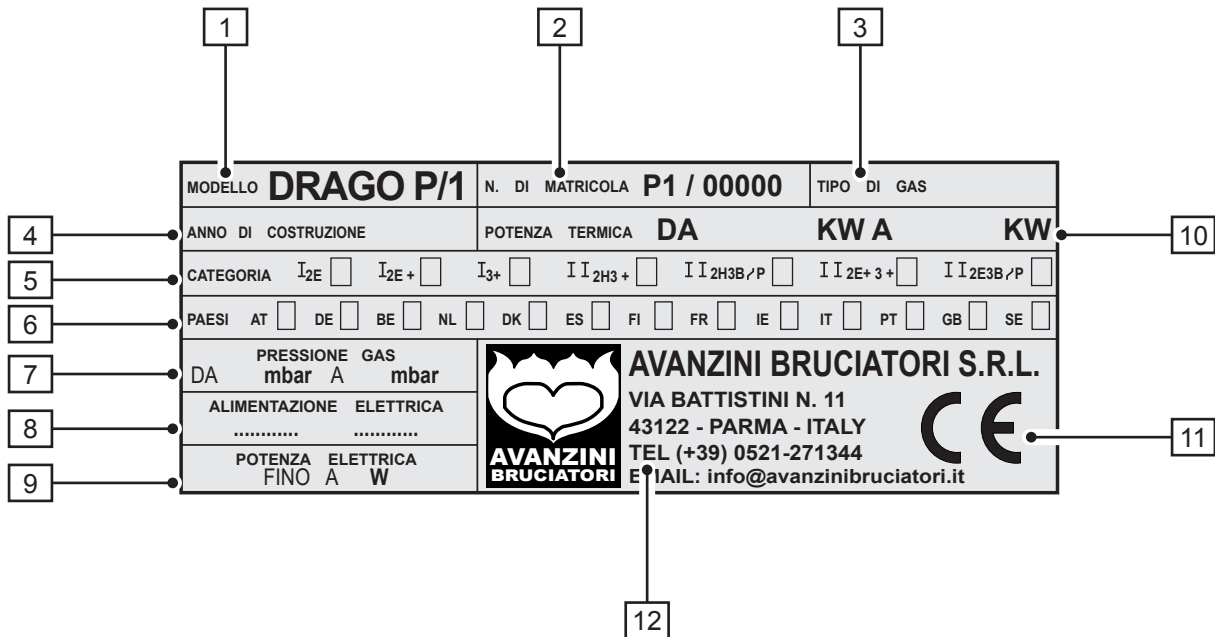

CAUTION!

IT IS STRICTLY PROHIBITED to remove the identification plate and/or replace it with other plates. Should the plate be damaged, detached or the manufacturer's seal be removed for accidental reasons, the customer must inform the Manufacturer.

1.4. DECLARATION OF CONFORMITY (COPY)

“CE” DECLARATION OF CONFORMITY

EQUIPMENT DRAGO

YEAR OF MANUFACTURE

DESCRIPTION

MODEL

REGISTRATION NUMBER

The undersigned *Andrea Avanzini* in quality of legal representative of the company *Avanzini Bruciatori S.r.l.*

DECLARATIONS

under his own responsibility that the equipment declared conforms to directives :

Directive **2014/30/EU** regarding electromagnetic compatibility.

Directive **2011/65/EU (RoHS II)** on the restriction of the use of certain hazardous substances in electrical and electronic equipment

and satisfies the essential requirements of:

REGULATION (UE) 2016/26 OF THE EUROPEAN PARLIAMENT AND OF THE COUNCIL of 9 March 2016 REGARDING compliance with gaseous fuels.

The photocopies of the certificates of the components of the equipment are attached

Parma, d.....

Best regards
AVANZINI BRUCIATORI S.r.l.
Avanzini Andrea
(managing director)

.....

1.5. REFERENCE DIRECTIVES

The equipment supplied by AVANZINI BRUCIATORI s.r.l. complies with the directives:

- Directive 2014/35/EU on low voltage, relative to safety guarantees that electrical material must possess when intended for use within certain voltage limits.
- Directive 2014/30/EU on electromagnetic compatibility.
- Directive 2011/65/EU (RoHS II) on the restriction of use of certain hazardous substances in electrical and electronic equipment.

and fulfils the essential requirements of:

- Regulation 2016/426/EU of the European Parliament and Council of 9 March 2016 on appliances that burn gaseous fuels.

2. GENERAL PRELIMINARY INFORMATION

2.1. MANUFACTURER IDENTIFICATION

The manual is intended for operators in charge of using and managing the plant in all the technical phases of its service life.

It also contains the subjects regarding the proper use of the machine, in order to maintain the functional and qualitative features of the machine unaltered over time. All information and warnings for proper safe use are also reported.

The manual, like the declaration of conformity, is an integral part of the machine and must always accompany it in every displacement or property transfer. The user must keep this documentation intact and make it available for consultation during the entire lifespan of the machine.

2.2. SUPPLY AND PRESERVATION

The manual is supplied in paper and electronic format.

All additional documentation (for example: pneumatic and wiring diagrams, sub-supplier manuals, etc.) is enclosed with this manual.

Keep this manual with the machine so that it can be easily consulted by the operator.

The manual is an integral part for the purpose of safety, therefore:

- it must be kept intact (in all its parts). If lost or damaged, you must immediately request another copy;
- it must accompany the machine until its demolition (even if moved, sold, leased, rented, etc.).

The attached manuals are an integral part of this documentation and the same recommendations/prescriptions of this manual apply.

Should the machine require functional modifications or replacements, the machine Manufacturer is responsible for revising or updating the manual. The Manufacturer is responsible for delivering the manual update.

2.3. UPDATES

Should the machine require functional modifications or replacements, the machine Manufacturer is responsible for revising or updating the manual. The Manufacturer is responsible for delivering the manual update.

The user is also responsible for ensuring that, should this document be modified by the manufacturer, only the updated manual versions are effectively present in the points of use.

2.4. LANGUAGE

CHAPTER 2



The original manual was edited in Italian.

Any translations into other languages must be done from the original instructions.

The Manufacturer considers itself responsible for the information in the original instructions. Translations in other languages cannot be fully verified, therefore, in case of a detected inconsistency, respect the text in the original language or contact our Technical Documentation Department.

2.5. MANUAL PAGE STRUCTURE

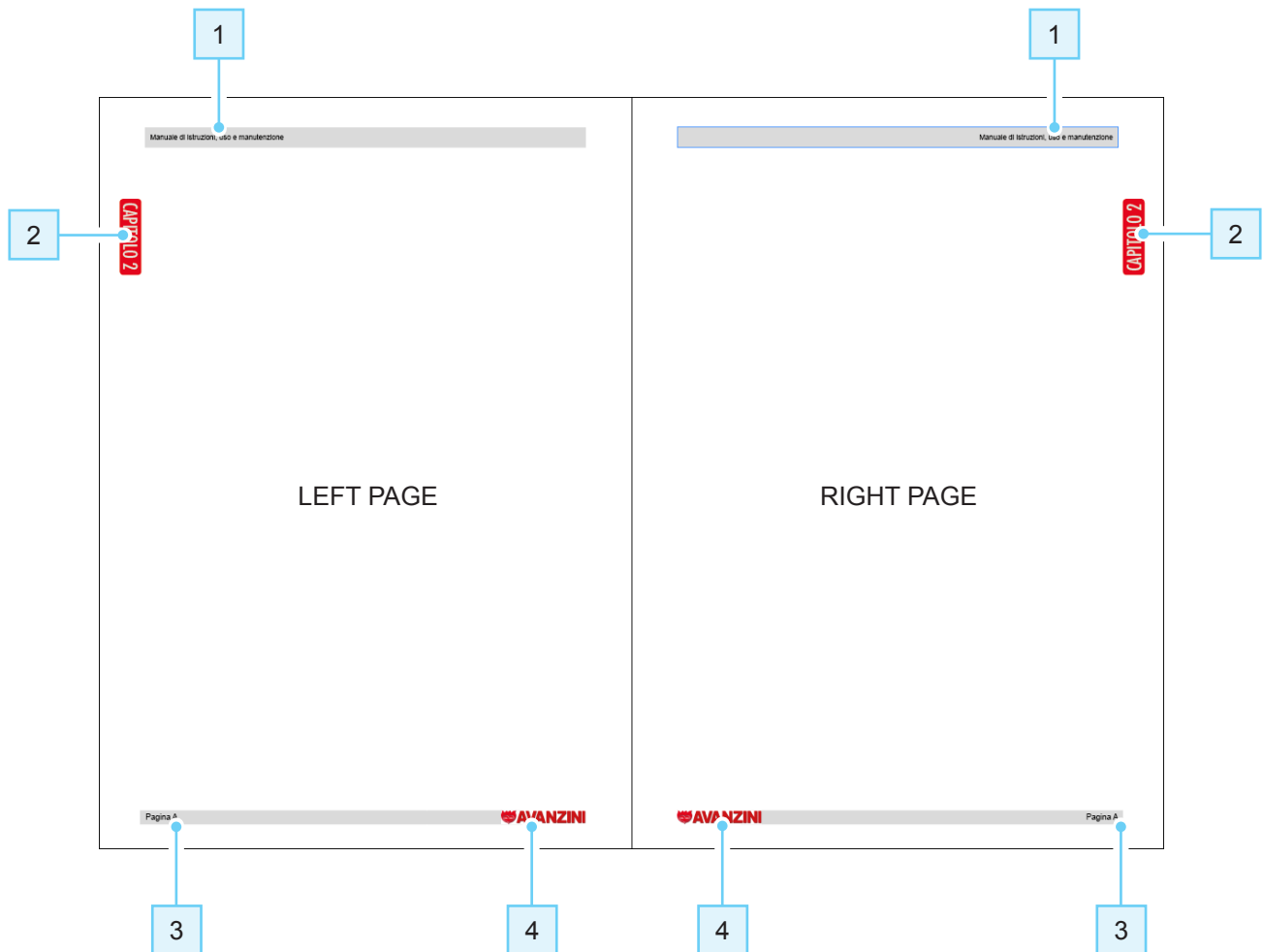

The master pages of this manual are structured so as to provide the user with important information on whatever page he/she is on:





POS.	ELEMENT
1	DOCUMENT TITLE
2	CHAPTER NUMBER
3	PAGE NUMBER
4	COMPANY LOGO

2.6. OPERATOR QUALIFICATIONS

In order to establish with certainty the skills and qualifications of the operators involved in the various tasks (operating, cleaning, ordinary maintenance), refer to the following table:



QUALIFICATION	DEFINITION
<p>OPERATOR</p> 	<p>This is the user's trained staff authorised to use and run the machine for production purposes, for the activities it was built and supplied for. He/She must be capable of performing all of the procedures required for good machine operation and his/her personal safety and that of other workers. Have proven experience in the correct use of this type of machine/system and be trained, informed and instructed thereof. Must report any anomaly to his superior in case of doubt.</p>
<p>MECHANICAL MAINTENANCE</p> 	<p>Qualified maintenance engineer able to carry out preventive/corrective maintenance activities on all the mechanical parts of the machines subject to maintenance or repairs. Qualified engineer who can access all the parts of the machine for a visual analysis, inspect the equipment status, carry out adjustments and calibrations. Qualified technician able to:</p> <ul style="list-style-type: none"> • run the machine as an operator; • intervene on the mechanical elements for adjustments, maintenance and repairs; • read pneumatic and hydraulic diagrams, technical drawings and spare parts list. <p>In exceptional cases, he/she is trained to run the machine under reduced safety conditions. Where necessary, it can provide the operator with instructions for the proper use of the machine for production purposes. Note: he/she is not authorised to work on live electrical systems (if installed).</p>
<p>ELECTRIC MAINTENANCE</p> 	<p>Qualified maintenance engineer able to carry out preventive/corrective maintenance activities on all the electrical parts of the machines subject to maintenance or repairs. Qualified engineer who can access all the parts of the machine for a visual analysis, inspect the equipment status, carry out adjustments and calibrations. Qualified technician able to:</p> <ul style="list-style-type: none"> • run the machine as an operator; • intervene on adjustments and electrical systems for maintenance, repair and replacement of worn parts; • reading wiring diagrams and checking the proper functional cycle. <p>Where necessary, it can provide the operator with instructions for the proper use of the machine for production purposes. The assembly technician can work while the electrical circuits in the electrical panel, junction boxes, control appliances, etc. are live only if the technician is suitably qualified (PEI). (See legislation EN50110-1).</p>

QUALIFICATION	DEFINITION
MANUFACTURER'S MANUFACTURER 	<p>Technician qualified by the manufacturer and/or by its distributor for complex operations, as he/she is aware of the constructive production cycle of the machine/plant.</p> <p>This person intervenes in agreement with the user requests.</p> <p>The competencies are, as appropriate, of mechanical and/or electrical and/or electronic and/or software type.</p>
SECOND LIFTING EQUIPMENT 	<p>Personnel in charge of using the material ad machine lifting and handling means (scrupulously following the instructions of AVANZINI BRUCIATORI s.r.l., in compliance with the laws in force in the country of the machine user.</p>
SOFTWARE EXPERT TECHNICIAN 	<p>Qualified technician able to:</p> <ul style="list-style-type: none"> perform preventive/corrective maintenance on all the electronic and/or software parts of the machine subject of maintenance or repairs; having access to all the parts of the machine for a visual analysis, control of the status of the equipment, adjustments and calibrations. <p>Qualified technician of the user with proven experience and training of systems based on: PLC/PC drivers, etc.(knowledge of programming, machine functions, etc.) for complex operations such as machine data modification, creating job parameters, adjusting drive parameters, etc. as he/she is aware of the production, technological and construction cycle of the supplied machine.</p> <p>Can operate in the presence of voltage inside the electrical panels, junction boxes, control equipment, etc. only if the person is suitably competent (PEI) (see EN 50110-1).</p> <p>The competences are the electronic and/or software type.</p>

The qualifications stated in the table on this page, compulsorily fall within a category of people defined "trained person".

QUALIFICATION	DEFINITION
TRAINED PERSON	<p>Person informed, educated and trained on the work and on any dangers deriving from an improper use. Also knows the importance of the safety devices, the accident-prevention standards and the safe work conditions.</p>

2.7. SYMBOLS USED IN THE MANUAL

SYMBOL	DESCRIPTION
	Symbol used to identify particularly important information in the manual. The information also regards the safety of personnel involved in use of the machine.
	Symbol used to indicate warnings or procedures related to operator safety.
	Symbol used to indicate warnings or procedures related to electrical power.

2.8. TERMINOLOGY USED

Technical terminology or different meaning from the ordinary used in the manuals. Below is an explanation of the terms and abbreviations used:

TERM	DESCRIPTION
EQUIPMENT INTERCHANGEABLE	Device that, after machine commissioning, is assembled to the machine by the same operator in order to modify its function or attribute a new function, in so far as such equipment is not a tool.
SAFETY COMPONENT	Component: <ul style="list-style-type: none"> intended to fulfil a safety function, placed on the market separately, the failure and/or malfunctioning of which endangers the safety of people, and which is not essential for the purpose for which the machine was designed or that for such function it can be replaced with other components. Attachment V contains an indicative list of the safety components that can be updated according to article 8, par. 1, letter a).
PLACING ON THE MARKET	First availability, within the Community, against payment or gratuitously, of a machine or a partly-completed machine for distribution or use.
MANUFACTURER	Individual or company that designs and/or manufactures a machine or a partly-completed machine covered by this directive, and is responsible for the conformity of the machine or partly-completed machine with this directive for placement on the market with its own name or own brand or for personal use. In the absence of a manufacturer as defined above, the individual or company which places the machine or partly-completed machine, covered by this directive, on the market or commissions it, is considered the manufacturer.
AGENT	Any individual or company established within the Community that has received a written mandate from the manufacturer to fulfil on his behalf, in whole or in part, the obligations and formalities related with this directive.
COMMISSIONING	First use, compliant with its destination, within the Community, of a machine covered by this directive.
HARMONISED STANDARD	Technical specification adopted by a standardisation body, or European Committee for Standardisation (CEN), the European Committee for Electrotechnical Standardization (Cenelec) or European Telecommunications Standards Institute (ETSI), in the framework of a mandate issued by the Commission in compliance with the procedures of Directive 98/34/EC of the European Parliament and of the Council dated 22 June 1998, providing an information procedure in the field of technical regulations and standards and of the rules concerning the services of the Information company (1), and not having a binding character.
DANGER	This word indicates a danger with a high risk which, if not avoided, entails death or severe injuries.
DANGER ZONE	Any area inside and/or near the machine where the presence of an exposed person constitutes a risk for the health and safety of that person.
EXPOSED PERSON	Any person fully or in part inside a dangerous area.
RISK	Combination of probability and severity of an injury or of damage to health that may arise in a dangerous situation.

2.9. SAFETY PICTOGRAMS

The machine is equipped with a series of pictograms which serve the purpose of warning the operator of any residual risks.



CAUTION!

IT IS STRICTLY FORBIDDEN TO REMOVE THE WARNING PLATES ON THE MACHINE.

AVANZINI BRUCIATORI s.r.l. will not be held liable for the safety of the machine should this prohibition be disregarded.



CAUTION!

The user must replace warning signs which have become illegible due to wear.



Below is a list of the plates that AVANZINI BRUCIATORI s.r.l. uses on its machines.

SYMBOL	DESCRIPTION
	Generic hazard! Warning, generic hazard (complete with caption specifying its type).
	Voltage hazard! Voltage present signal which is found affixed to electrical cabinets, pushbutton panels, electric motors, electro-pneumatic drivers, encoders, and any other structure that has electrical power inside.
	Danger, hot surface! Burns hazard.
	It is prohibited to put your hands inside! Switch off the power supply before starting any work.

2.10. PERSONAL PROTECTIVE EQUIPMENT

When operating near the machine for assembly and maintenance and/or adjustment operations strictly respect the main accident-prevention rules. For this purpose it will be important to use the personal protective equipment (P.P.E.) required for each individual operation.

Below is the full list of personal protective equipment (P.P.E.) that may be required for the different procedures:

SYMBOL	DESCRIPTION	
	Compulsory use of protective or insulating gloves	Indicates a requirement for personnel to use protective or insulating gloves.
	Compulsory use of safety footwear	Indicates a requirement for personnel to use work-safety footwear to protect their feet.

The clothing worn by individuals running the line or performing maintenance must comply with the essential safety requisites defined by Reg. EU 2016/425 and the regulations in force in the country where it is installed.

2.11. WARRANTY

- The seller guarantees there are no defects for a period of one year from the date of the invoice considering the current technological stage in relation to the type of machine.
- The right to services under warranty is only acknowledged if it is reported to AVANZINI BRUCIATORI s.r.l. as soon as the defect is noted and simultaneously submitting the relevant repair order.
- Without prejudice to the time frame set out in the previous point concerning the warranty, this also extends to parts of the machine that are not manufactured directly by AVANZINI BRUCIATORI s.r.l., excluding electrical parts.
- The seller shall provide warranty at its own discretion, in accordance with the technical requirements, the repairs or replacement of faulty parts.

There is no right to the warranty if the defect occurs in relation to the following cases:

- when the buyer has not reported the defects to the seller within eight days of their discovery, in writing and commissioning the relevant intervention;
- the machine or its parts have been used differently from the intended use;
- the machine has been previously entrusted to a service not authorised by AVANZINI BRUCIATORI s.r.l. for repairs;
- parts whose use has not been authorised by AVANZINI BRUCIATORI s.r.l. have been fitted or replaced on the machine;
- the requirements for use and maintenance of the machine described in the respective manual have not been complied with.

The warranty does not cover:

- Faults, defects and damage resulting from normal wear, bad weather and natural events, from improper use or poor maintenance.

The warranty provides for the replacement of defective parts free of charge.

Costs for labour and any technician travel expenses are excluded, as well as shipping spare parts and any additional expenses incurred for the repair.

Without prejudice to the buyer's right to services under warranty in accordance with the terms set out above, it is specifically excluded that the buyer can request to terminate the contract, replace the machine, reduce the selling price, and request compensation for any direct or indirect damage.

The right to the warranty must only be exercised toward dealers authorised by the Manufacturer or directly to AVANZINI BRUCIATORI s.r.l..

3. SAFETIES

3.1. SAFETY DEVICES

In order to guarantee full operator safety and prevent access inside the machine while this is moving, the machine has been fitted with a series of safety devices that, in case of activation, ensure its complete stop.



CAUTION!

Removing or tampering with the safety devices implies a dangerous situation for the operator, which could result in a serious accident that could lead to serious physical harm.

Removing or tampering with safety devices relieves AVANZINI BRUCIATORI s.r.l. from any kind of civil or criminal liability and/or any compensation towards the injured party.

The machine is provided with the safety devices listed in the following table.

Refer to the instructions below for the position of these devices.

POS.	NAME
1	THERMOCOUPLE

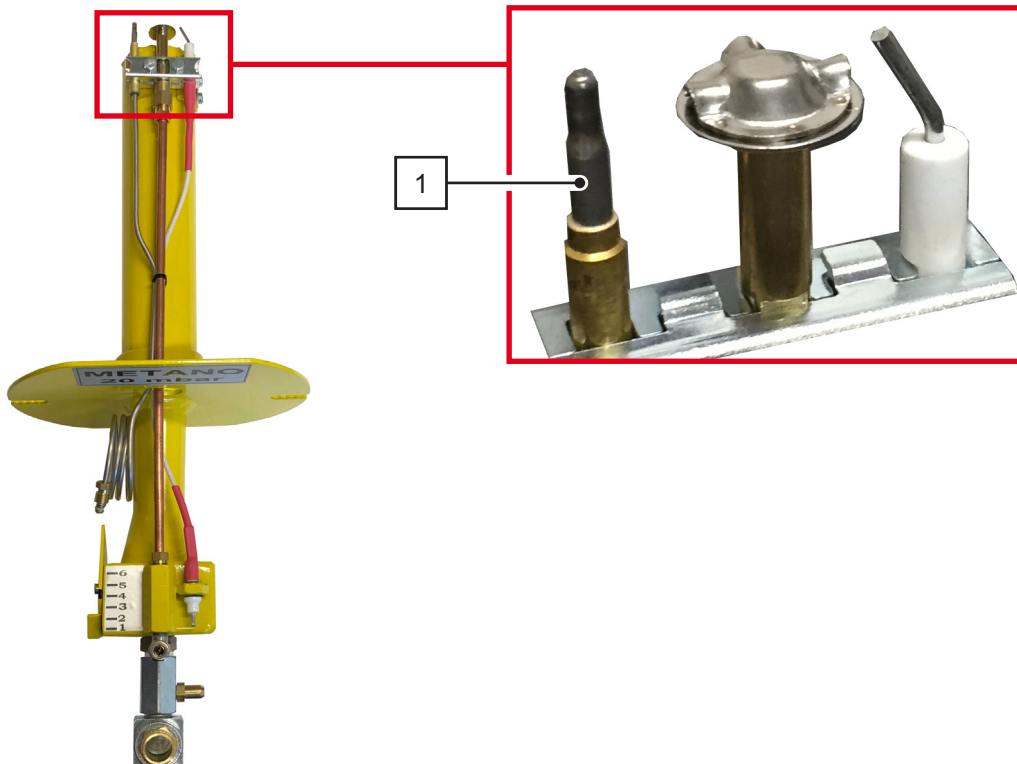

3.2. NOISE

The noise levels have been measured in accordance with the requirements of UNI EN 11200 and UNI EN ISO 3746. During the operating cycles, the levels of exposure to noise for appointed personnel do not exceed 76 dB. The actual noise levels of the installed machine during operation on site in a manufacturing process differ from those detected, as the noise is influenced by factors such as:

- type and features of the site;
- type of processed material;
- other adjacent machines in operation.

It is the user's responsibility to apply the consequent preventive and protective measures, in compliance with the law of the country of installation and use of the machine.

3.3. VIBRATIONS

The machine does not produce any vibrations due to the constructive type and the absence of moving components.

3.4. ELECTROMAGNETIC COMPATIBILITY

The supplied machine contains electronic components subject to the Electromagnetic Compatibility Standards, influenced by conducted and radiated emissions.

The values of the emissions respect the legislative requirements thanks to the use of Electromagnetic Compatibility Standard components, suitable connections and the installation of filters, where required.





The machine, therefore, conforms with the EMC directive.





3.5. RESIDUAL RISKS

This machine was designed to guarantee the essential safety requirements for the operator. Safety has been incorporated, as much as possible, into the design and construction of the machine; however, there are risks from which the operators must be protected, especially during:

- transport and installation;
- normal operation;
- adjustments and fine tuning;
- maintenance and cleaning;
- disassembly and dismantling.

For each residual risk, there is a description of the risk and of the area or part of the machine subject to that residual risk (unless the risk is valid for the entire machine). Information is also provided on proper use of the personal protective equipment foreseen and required by the manufacturer.

RISK	DESCRIPTION AND PROCEDURAL INFORMATION
<p style="text-align: center;">RISKS DUE TO HANDLING</p> <p style="text-align: center;">Required PPE</p> <div style="text-align: center;">  </div>	<p>Handling procedures are described in this instructions and warning manual in the “Transport, handling and installation” chapter.</p> <p>The following operations:</p> <ul style="list-style-type: none"> • unloading the packages; • opening the packages; • handling the parts, • expose operators to the risk of crushing. <p>These operations must only be performed by qualified personnel.</p>
<p style="text-align: center;">RISKS RELATED TO ASSEMBLY, INSTALLATION AND START-UP</p> <p style="text-align: center;">Required PPE</p> <div style="text-align: center;">  </div>	<p>Assembly procedures are described in this instructions and warning manual in the “Transport, handling and installation” chapter.</p> <p>The following operations:</p> <ul style="list-style-type: none"> • assembly, • fastening, • connection to power sources, • operational tests • expose operators to the risk of crushing and electrocution. <p>These operations must only be performed by qualified personnel.</p>
<p style="text-align: center;">USE OF THE MACHINE</p> <p style="text-align: center;">Necessary PPE</p> <div style="text-align: center;">  </div>	<p>Use procedures are described in this instructions and warning manual in the “Use” chapter.</p> <p>The operations expose operators to the risk of contact with hot surfaces.</p>
<p style="text-align: center;">CLEANING AND MAINTENANCE</p> <p style="text-align: center;">Necessary PPE</p> <div style="text-align: center;">  </div>	<p>Cleaning and maintenance procedures are described in this instructions and warning manual in the “Use” Chapter.</p> <p>The operations expose operators to the risk of contact with hot surfaces.</p> <p>These operations must only be performed by qualified personnel.</p>
<p style="text-align: center;">FIRE RISK</p> <p style="text-align: center;">Required PPE</p> <div style="text-align: center;">  </div>	<p>The customer shall take all the measures necessary to prevent the risk of fires.</p> <p>In particular we recommend:</p> <ul style="list-style-type: none"> • Do not smoke near the machine. • Do not use naked flames.

RISK	DESCRIPTION AND PROCEDURAL INFORMATION
<p>RISK OF EXPLOSIVE ATMOSPHERE</p> <p>Required PPE</p> 	<p>The machine is not suitable to operate in explosive or classified environments.</p> <p>Using it in explosive or partially explosive atmospheres is strictly prohibited.</p> <p>The machine is therefore not suitable to work in the following environments:</p> <ul style="list-style-type: none"> • explosive or partially explosive; • with high dust concentrations; • with the risk of fire resulting from any material or triggering source.
<p>STATIC ENERGY RISK</p> <p>Necessary PPE</p> 	<p>Failure to disconnect the electrical part during maintenance and failure to respect the prescriptions indicated by the manufacturer in the instructions and warnings manual.</p>
<p>ELECTRICAL POWER RISK</p> <p>Required PPE</p> 	<p>The following safety measures are recommended:</p> <ul style="list-style-type: none"> • Pay the utmost attention to the safety labels regarding the electrical risk. • Do not perform maintenance without first having electrically cut off and locked the machine. <p> CAUTION! Do not operate without using specific PPE with a double insulation protection.</p>
<p>LIGHTNING</p> <p>Necessary PPE</p> 	<p>The evaluation of the equipment necessary for protection against lightning in order to transmit any electrical discharges to the ground is the responsibility of the user/final customer.</p> <p>Inform maintenance personnel and make sure that they are properly instructed in carrying out the activity as well as aware of the residual risks present.</p> <p>Make sure that the earth connections are always connected and efficient. It is prohibited to perform maintenance on the electrical equipment with the plant running in harsh weather conditions (risk of lightning or storms).</p> <p>Always wear clothing suitable for the work to be performed</p> <p>The earthing system must be checked as frequently as laid down by law.</p>

It is the responsibility of the user to:

- analyse the risks that might occur during handling and installation at his/her premises (the analyses done on the handling of the machine only took into consideration the characteristics of the same);
- awareness-raising and training of the personnel in charge of performing operations on work stations as well as machine operators;
- apply the visual safety signs in the work environment after having evaluated the risks inside the areas of transit or control.

4. DESCRIPTION OF THE MACHINE

In order to assure the maximum operating reliability, AVANZINI BRUCIATORI s.r.l. has carefully chosen the materials and components used in constructing the machinery, having it undergo a regular test inspection before delivery. The materials used are also suitable for contact with food products. Its proper performance over time depends on correct use and proper preventive maintenance according to the instructions provided in this documentation and in the documentation supplied together with the machine.

All the constructive elements and the connection and command devices have been designed and manufactured with a degree of safety capable of withstanding abnormal stress, or anyway higher than that indicated. We use the best quality materials and their introduction to the company, storage and use at the workshop are constantly controlled to guarantee they have no damage, deterioration or malfunctioning.

Despite the design and constructive measures taken, it is of the utmost importance to strictly follow the manufacturer's indications for the proper use, safety, long life and reliability of the machine.

The maintenance section of the instructions and warning manual indicates the types of maintenance foreseen for the machine (routine and extraordinary maintenance), as well as the frequency of maintenance and all the information required to carry it out properly.

4.1. INTENDED USE (CORRECT)

The machine described in this manual called “BurnerDrago P1” was designed and built to heat up ovens for the purpose of baking bread and pizza.

The machine is intended for:

INTENDED USE	UNINTENDED	WORK ENVIRONMENT
Heating of ovens for cooking bread and pizza	Any use other than heating food ovens	Foodstuff

The machine was designed to:

- satisfy the specific demands mentioned on the sales agreement;
- be used according to instructions and limitations for use set out in this manual.

The machine is designed and built to work safely if:

- it is used within the limits stated in the contract and in this manual;
- the usage manual procedures are followed;
- the maximum expected production is not exceeded;
- routine maintenance operations are performed as indicated;
- extraordinary maintenance is performed promptly, in case of need;
- safety devices are not removed and/or modified.

4.1.1. REASONABLY FORESEEABLE IMPROPER USE

Reasonably foreseeable misuse is listed below:

- installation with modes different from what has been specified in this user manual;
- using the machine so as to achieve greater production values than the prescribed limits;
- using the machine with modes different from what has been specified in this user manual.

Any other use of the machine shall be previously authorised in writing by the Manufacturer. Should the user not have written authorisation, any use is to be regarded as "improper use". Therefore, the Manufacturer shall deny any liability for damage caused to persons or objects and the warranty on the line and machinery shall cease.

4.2. OBLIGATIONS AND PROHIBITIONS

4.2.1. USER OBLIGATIONS

The user (entrepreneur or employer) must:

- consider the abilities and conditions of the operators in relation to their health and safety;
- provide personal protective equipment appropriate to the individual procedures;
- request compliance by the single workers to the company provisions and standards with regard to safety and use of the collective and personal protective equipment provided to them;
- train personnel on procedures in case of accident;
- train personnel on the safety devices provided for the operators;
- train personnel on the noise emission risks in the work environment;
- train personnel on the general accident-prevention rules provided by the European Directives and laws in the country of destination of the plant.

Only let personnel who have read this manual and are appropriately trained to work on the machine.

4.2.2. OPERATOR OBLIGATIONS

- Carry out maintenance operations with the machine switched-off.
- Always switch the main switch off when you have to perform interventions on the electrical switchboard, junction boxes, cables or other electrical components.
- When starting the machine, make sure that no-one is standing in the danger zones.
- Appropriately use the protective devices provided by the employer.
- Immediately inform the employer, the manager or the person in charge, of deficiencies of the safety devices.

4.2.3. PROHIBITIONS FOR THE OPERATORS

In particular the operators must not:

- introduce objects other than the food to be cooked near the burner;
- approach body parts to the nozzles and to the electrode with cable;
- use the machine improperly, that is for different uses to those indicated in paragraph “Intended Use”;
- remove or modify safety or warning devices without authorization;
- carry out, upon their own initiative, operations or manoeuvres they are not in charge of or that can jeopardise their own safety and that of other workers;
- work with products other than those provided for herein;
- modify the electric connections to exclude the internal safeties;
- use the machine if it has not been correctly installed according to regulations in force;
- use the machine outside the admitted environmental conditions (consult chap. 5).



CAUTION!

The company AVANZINI BRUCIATORI s.r.l. is not liable for damages to property or people if it has been ascertained that the machine has been used in one of the above environments.

- Disassembling safety devices during operation is prohibited.
- Using the machine, or parts of it, for uses other than those listed in this manual is prohibited.
- Modifying and/or moving parts of the machine is prohibited.
- It is prohibited to use the machine with devices or elements other than those recommended by the Manufacturer.
- Do not operate the machine or the equipment if under the influence of alcohol, medication or drugs.

4.3. TECHNICAL DATA

DIMENSIONS	BURNER DEPTH	P1 vertical 200 mm - P1 square 500 mm
	BURNER WIDTH	200 mm
	BURNER HEIGHT	350 - 600 mm
DIMENSIONS	CONTROL UNIT DEPTH	200 mm
	CONTROL UNIT WIDTH	200 mm
	CONTROL UNIT HEIGHT	200 mm
DATA	BATTERY	AA 1.5 V
	TOTAL MASS (including packaging)	12 kg



CAUTION!

For additional information, consult the wiring diagram provided in the "ATTACHMENTS" chapter of this manual.

4.4. MAIN COMPONENTS

POS.	ELEMENT
1	MANUAL CONTROL PANEL WITH KNOB
2	IGNITION KNOB AND FLAME ADJUSTMENT
3	PILOT FLAME IGNITION BUTTON OR ON BUTTON
4	BURNER FIXING FLANGE
5	THERMOCOUPLE TIP
6	GAS CONNECTION FITTING (from the control panel with knob to the burner)
7	ELECTRICAL IGNITION CONNECTION
8	PILOT FLAME GAS PIPE FITTING
9	AIR REGULATOR
10	IGNITION ELECTRODE
11	PILOT FLAME
12	GAS SUPPLY
13	GAS PRESSURE INLET

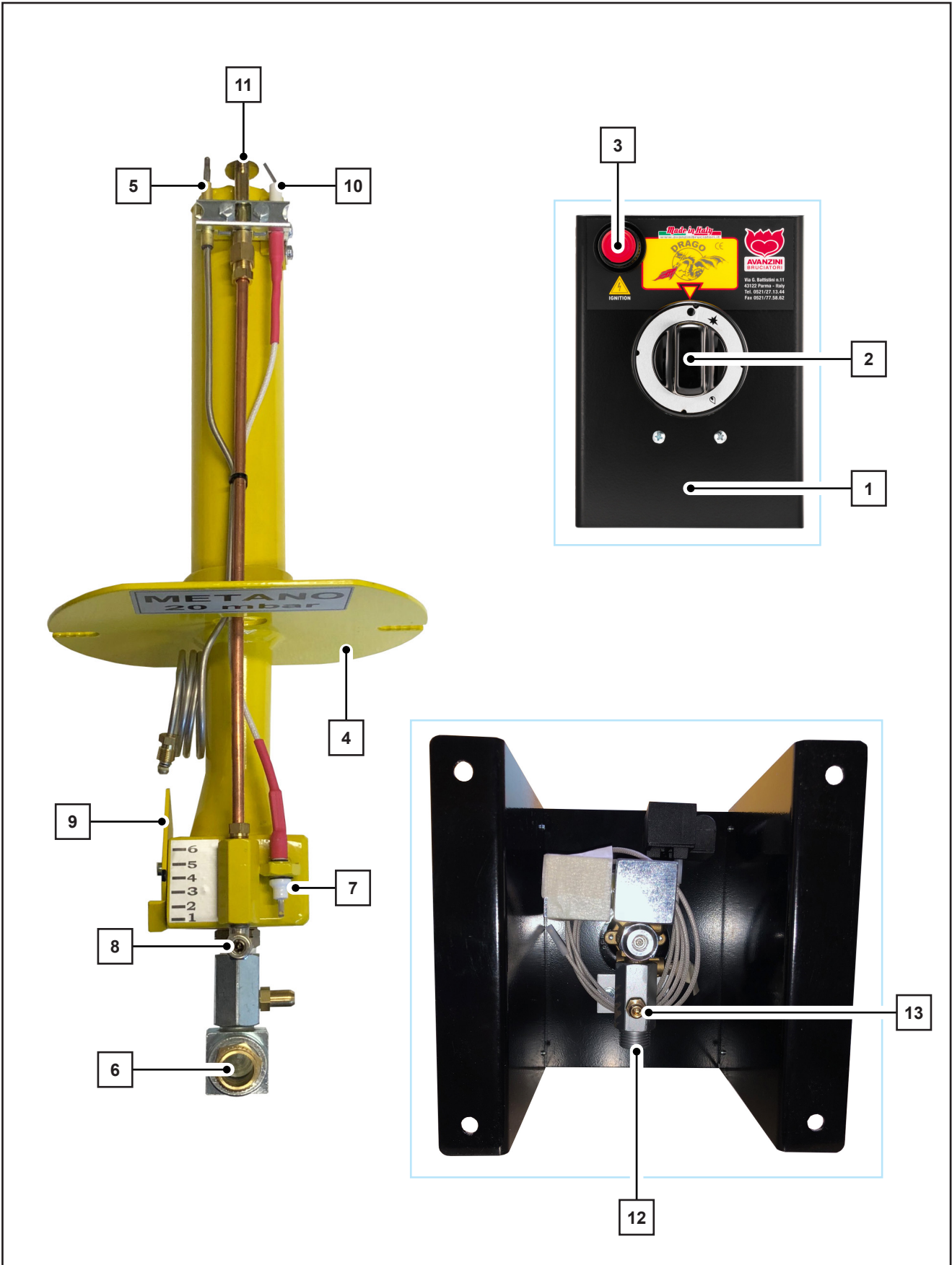

4.5. WORK CYCLE

The machine is designed to heat a food industry oven for baking bread and/or pizza.

The operator turns on the burner pilot flame using the controls on the control panel; using the ignition and flame adjustment knob, the operator can raise or lower the intensity of the flame and consequently, the internal temperature of the oven.

At the end of the work cycle, the operator switches off the flame and the control unit.

5. TRANSPORT AND INSTALLATION

5.1. INTRODUCTION

**CAUTION!**

Lifting and handling must only be done by specialised and trained personnel, who are qualified to perform these activities.

To handle the machine, respect the indications and pictograms shown, using suitable tools and equipment.

During installation, the AVANZINI BRUCIATORI s.r.l. technicians must be assisted by operators who are assigned for future maintenance and operation of the machine.

The machine was designed in such a way as to not require the use of equipment such as cranes, gantries or forklift trucks during the packaging, transport and assembly phases.

5.2. PACKAGING

Depending on the transport distance, on the Customer's specific requests and on the amount of time that the load will stay packed, the machine is shipped as follows:

- protective packaging with polyethylene bubble sheets without base, for short and medium distances;
- protective packaging, securing the machine on a wooden base (with protective crate if necessary) for long distances.

In case the packing is secured to the base, the machine will be secured to such base by means of metal brackets, which must be removed before handling the machine.

Shipment must be made using covered or sheeted transport means depending on the type of load.



CAUTION!

Before opening the packaging, its integrity must be checked and any anomalies must be communicated to AVANZINI BRUCIATORI s.r.l.

Upon receipt of the machine, the customer must verify that there are no damages caused by the method of transport or by the personnel in charge of the specific operations.

In case damages are ascertained, leave the packaging in question as found and immediately request assessment of the damage by the competent shipping company, and then with a surveyor's report, inform the competent transport insurance company and the seller.

After having checked machine integrity, the fastening screws in the wooden base can be removed to then proceed with handling as instructed in the next paragraph.

All the packaging material must be kept for any future transport.

In particular, if there is a wooden base and/or crate, brackets fastening the machine to the packaging must also be carefully kept in addition to the base itself.

The material must be stored in a suitable place so that it is not subject to deterioration, which could dangerously reduce the capacity of the package structure (e.g. weakening of the timber due to constant humidity or parasites).

5.3. TRANSPORT AND HANDLING

AVANZINI BRUCIATORI s.r.l., uses the most appropriate packing and fastening materials based on machine type and mode of transportation to ensure the machine is not damaged during shipping.

The handling procedures described in this paragraph shall be carried out by staff trained for such operations; suitably trained personnel to safely perform loading, unloading and handling operations of parcels by means of lifting equipment, and aware of accident-prevention rules.



CAUTION!

Fragile components and equipment must be packed so as not to be damaged during transport.



CAUTION!

AVANZINI BRUCIATORI s.r.l. is not responsible for any damage to persons or property stemming from accidents caused by failure to follow the instructions laid out in this chapter and those which follow.



CAUTION!

The machine must be installed according to the layout agreed upon with the manufacturer.

5.3.1. INFORMATION ABOUT TRANSPORT AND HANDLING



CAUTION!

Considering that the installation operations (including assembly and start-up) require specific knowledge of the machine and may pose risks for unqualified personnel, the manufacturer requires that the machine be handled and installed, at the customer's premises, only by personnel who are qualified or trained by AVANZINI BRUCIATORI s.r.l.

Before installing the machine and therefore before any handling is carried out, verify that:

- the stability of the load does not lead to danger and/or accidents;
- the means of transport and logistics structures are suitable for this purpose (that they are suitable for the maximum capacity, for example) and in perfect operating conditions;
- the operators are equipped with suitable personal protection equipment;
- the installation surface is large enough, considering the extra space required for assembly;
- the utility connection points are set up as per attached diagrams (and agreed upon with the Customer);
- the area is set up for installation and the access routes are clear of any obstructions;
- the height and width are sufficient for passage (leave at least a distance of 1000 mm from walls, pillars, and anything that may become an impediment to maintenance or escape in case of need);

Observe the precautions and warnings listed below in order to guarantee stability, thus avoiding risks related to the handling of the machine.

5.3.2. TABLE OF UNITS AND OF WEIGHTS

The following table contains weight information on handling the various units constituting the machine.

UNIT	WEIGHT
MACHINE + PACKAGING	12 Kg

Machine transport procedures are described on the following pages.



IMPORTANT!

Check overall mass: if the machine is paired or packaged with other units, you must refer to the transport documents. If these are not available, contact the Manufacturer.

5.4. ARRANGEMENTS TO BE MADE BY THE CUSTOMER

With the due exceptions made in the contract, the machine Customer user must provide:

- auxiliary utilities suited to system requirements (such as gas network, etc.). The requested features are contained in the contract of sale.
- trade tools and consumables required for assembly and installation.

The above data is described in the relative paragraphs.



CAUTION!

All external power supply connections to the machine must be made during installation by AVANZINI BRUCIATORI s.r.l. personnel.

5.5. INSTALLATION ENVIRONMENT

The installation environment is crucial for proper burner operation, since it has to guarantee proper air contribution to the burner.

The burner can be installed in one of the following ways:

- oven installed indoors;
- oven installed indoors, with oven loading door in a separate room;
- oven installed outdoors.



CAUTION!

The configuration of the installation environment is a crucial parameter in order to ensure proper burner operation.

5.5.1. INSTALLATION SITE



IMPORTANT!

The installation environment must be free of draughts that may cause malfunctions, such as irregular flames or burner shut-downs.

If the characteristics of the installation environment make it impossible to eliminate any existing draughts, (e.g., oven installed in a room with 2 windows opposite each other), the base of the oven must be closed on the sides and in the rear (leaving only the front side open) so as to protect the burner from draughts without however isolating it from the environment, and air intake is still possible.

In case the oven is installed by resting it on a closed base, you need to create a minimum opening of 500 x 500 mm under the oven loading door, in order to ensure the burner the proper amount of air.

5.5.2. OVEN INSTALLED INDOORS



IMPORTANT!

The room where the burner is to be installed must be equipped with a **SUITABLE AIR INTAKE**.



CAUTION!

The burner air intake must be such as to make it impossible to close it and/or tamper with it.

AIR INTAKE CHARACTERISTICS FOR OVEN INSTALLED INDOORS

RECTANGULAR OPENING	150 x 150
ROUND OPENING	ø 160 min.

During the installation phase, in case an extractor hood is present in the room, you need to enlarge the air intake, taking into account the air subtracted by said hood.

During regular operation, the burner uses from 30m³ to 40m³ of air every hour; please refer to the data of the extractor hood rating plate in order to properly size the opening of the air intake that services the burner.

5.5.3. OVEN INSTALLED OUTDOORS, WITH OVEN LOADING DOOR IN A SEPARATE ROOM (INDOORS)

In this case, the oven in which the burner is installed is outdoors, while the oven loading door is positioned indoors.

However, for proper operation, the burner and the oven loading door have to take in air from the same environment in order to avoid pressure differences that may result in malfunctions.

In case the burner has to be installed in this type of environment, the following needs to be done:

STEP	ACTION
1	Create an air intake opening under the oven loading door with minimum dimensions of 500 x 500 mm.
2	Completely close the external perimeter of the oven base, so that the burner can take in air only from the same environment as the oven loading door.
3	Carry out all the operations described in the paragraph "OVEN INSTALLED INDOORS".

The proper installation is shown in the following figures:

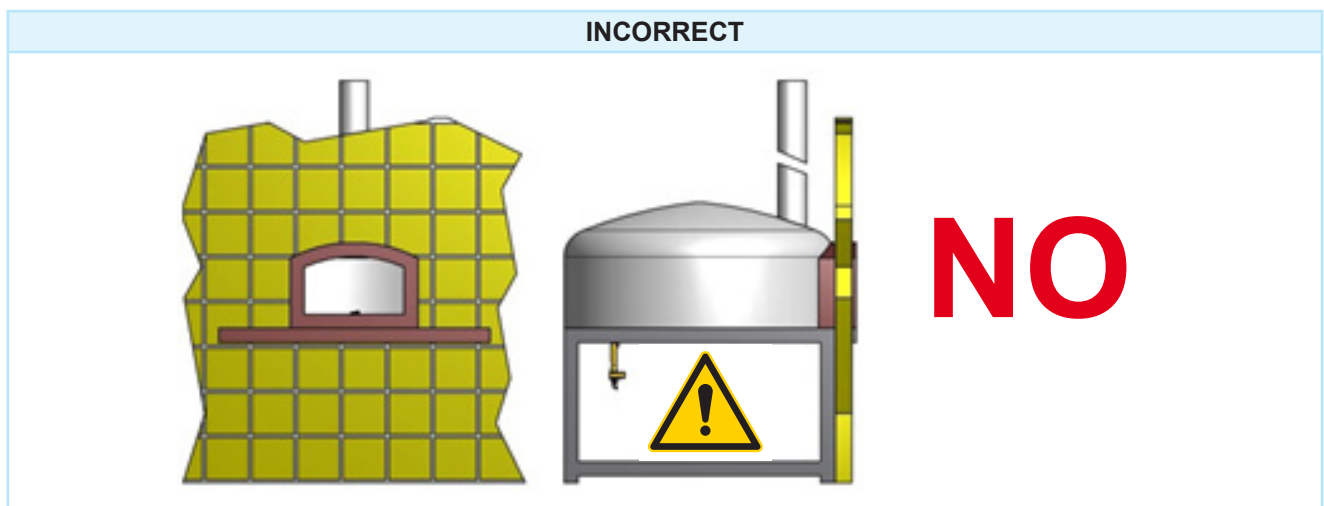
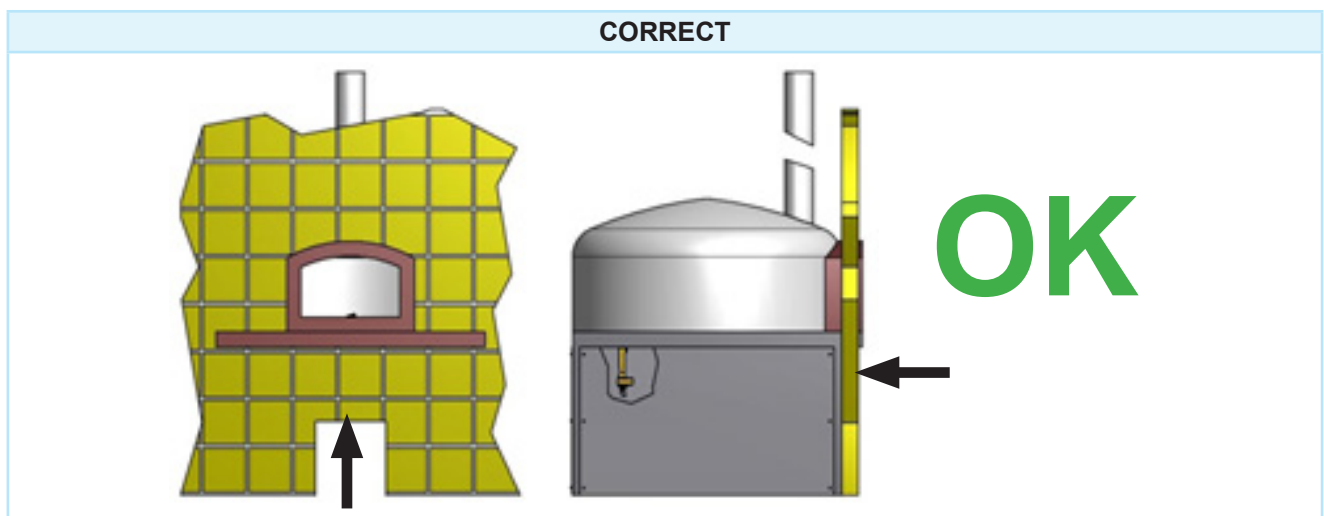

5.5.4. OVEN INSTALLED OUTDOORS

To install the oven outdoors, follow the same instructions provided in item **5.5.3**.

Close the oven base on the 2 sides and in the rear, leaving the front part under the oven loading door open. This configuration will prevent any draughts that would interfere with proper burner operation.

5.6. OPERATIONS ON OVEN INSTALLATIONS

This paragraph describes the physical characteristics and setting up procedures of the oven where the machine will be installed.

The procedure described below can be followed in order to convert a conventional wood-burning oven into an oven equipped with gas burner.

5.6.1. HOLE IN THE COOKING TOP

The Drago P1 burner is installed in the surface of the oven; the extensions of the torches have to pass through the oven base, until they reach the level of the cooking surface.

This is done by means of drilling a special hole with diameter of 110 mm and positioned at 50 mm from the inside wall of the oven.

In the following layout, you can see the area of proper positioning of the hole.

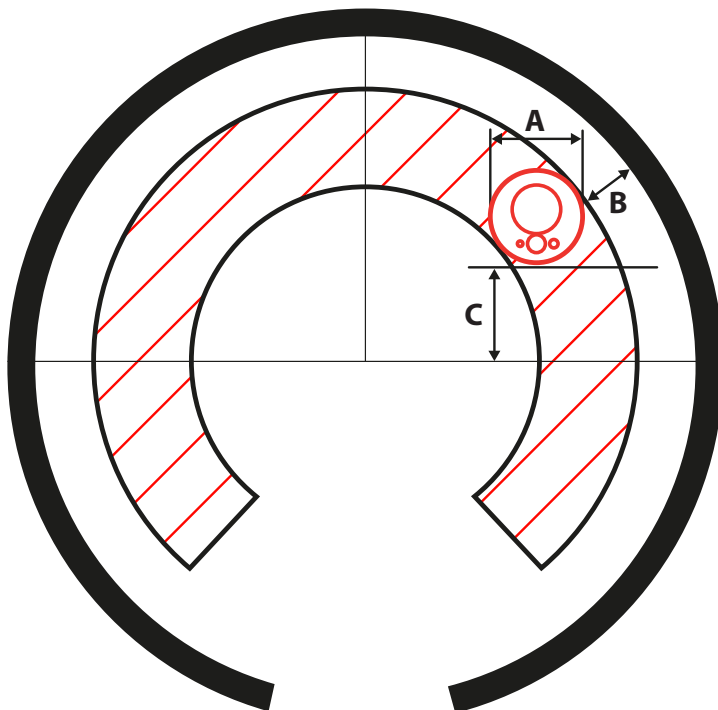

IDEAL POSITION OF THE HOLE

A	110 mm
B	50 mm
C	100mm

The AVANZINI BRUCIATORI s.r.l. recommended position is the side part, either left or right, at a distance of 100 mm from the central axis; nonetheless, you can position the burner anywhere in the area marked off with a red dotted line.

The company AVANZINI BRUCIATORI s.r.l. does not authorise any type of installation other than the indicated layout.

The customer is solely responsible for making sure the final installation is in compliance with the requirements in force.



CAUTION!

The machine, having to be used inside a production plant, is not equipped with its own fire-prevention system. The user must evaluate the need for an adequate fire-prevention system for the machine/site where the machine is installed and used.

5.6.2. POSITION FOR TEMPERATURE MEASUREMENT

The ideal position for measuring the temperature is on the side **opposite** the burner.



IMPORTANT!

THE PROBE MUST ALWAYS BE POSITIONED ON THE SIDE OPPOSITE THE BURNER
(Ex. if the burner is on the right, the probe must be positioned on the left).

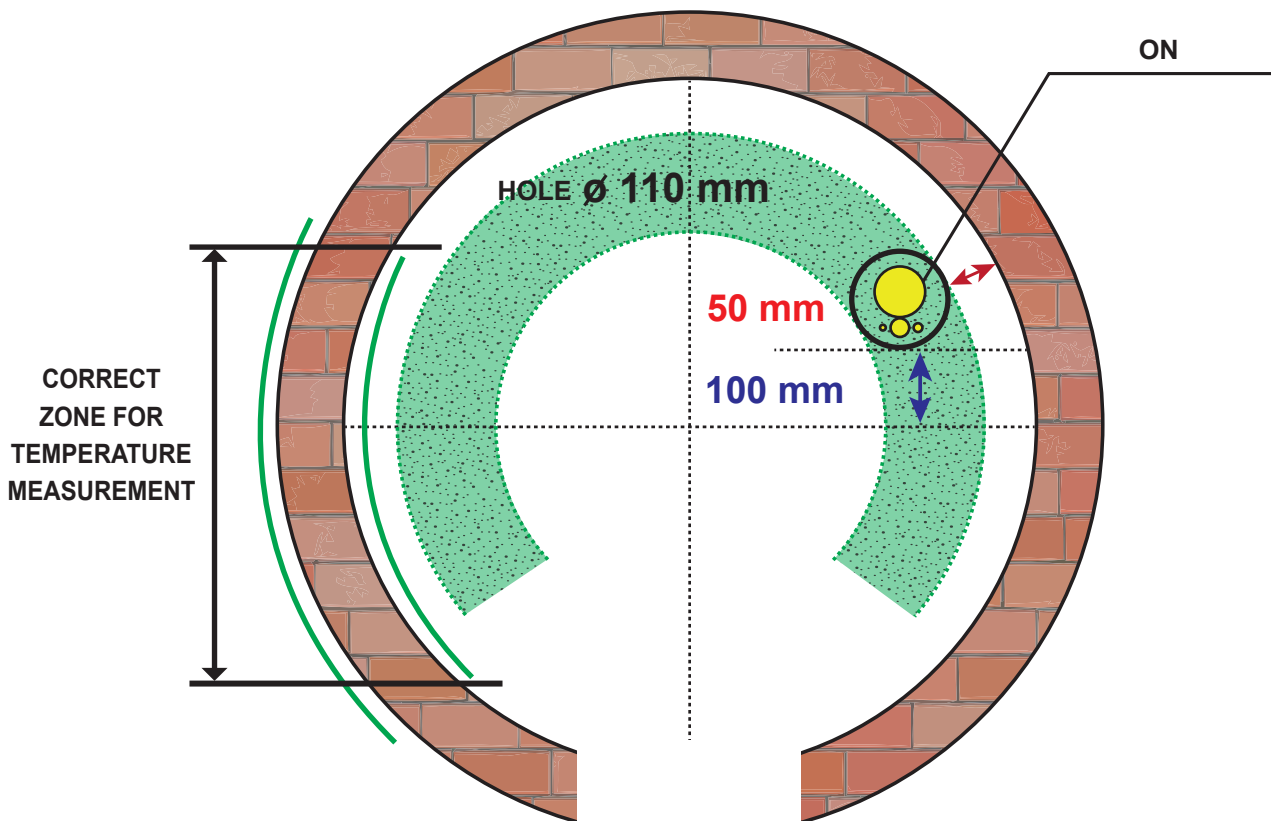

5.6.3. HOLE FOR THE TEMPERATURE PROBE

The temperature probe requires a 10mm diameter hole:

- in the side wall of the oven, making the hole so that it is positioned at a distance of 30 - 40 mm above the cooking surface.

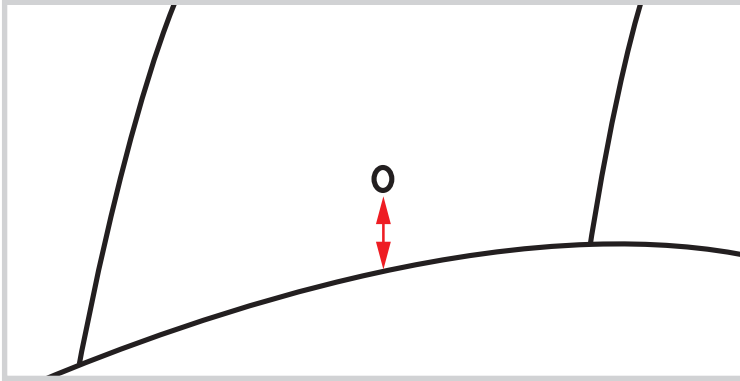
**CAUTION!**

Good burner operation depends on the proper positioning of the temperature probe.

Make sure you position the temperature probe in compliance with the specifications recommended by AVANZINI BRUCIATORI s.r.l.

**CAUTION!**

If the oven does not have a temperature signalling probe, it is possible to request one as an option from AVANZINI BRUCIATORI s.r.l.

5.6.4. FLUE

In order to guarantee flue evacuation, the cooking oven must be equipped with a flue as a continuation of the chimney to the ceiling, which must extend about 50 cm from the top.

The flue diameter cannot be smaller than the chimney outlet diameter.



CAUTION!

Prior to the installation, always carry out the development calculations needed for proper sizing of the flue.

The minimum recommended height of the flue exiting the chimney is at least 3 m vertically, in order to ensure sufficient draught and proper fume evacuation.



CAUTION!

Insufficient draught of the flue may lead to burner malfunctions, such as irregular operation and incorrect heat distribution inside the cooking oven.

AVANZINI BRUCIATORI s.r.l. is relieved of any and all responsibility with regards to breakdowns caused by improper sizing or by incorrect installation of the flue.

In case the flue need to run horizontally in some sections, increase its length by 2 vertical metres for each horizontal metre.

For better burner operation AVANZINI BRUCIATORI s.r.l. recommends the installation of a draught regulator, in order to regulate the amount of heat to vent from the oven through the negative pressure of the chimney.

The draught regulator can be positioned at the exit of the oven chimney or, alternatively, in the first section of the flue exiting the chimney.



CAUTION!

The proper negative pressure measured at the oven door must be equal to $-0.1 \text{ mm H}_2\text{O}$ (negative pressure).

Operate the draught regulator, where present, until the proper value is reached.

The draught pressure can be measured at the oven loading door using a draught gauge, and by manually operating the regulator until the desired value is obtained.

In case a draught gauge suited to the measure to be carried out is not available, carry out the following procedure for the adjustment:

STEP	ACTION
1	Close the draught regulator gate until you can perceive the slightly pungent smell unburnt gases when standing in front of the oven loading door.
2	Gradually open the draught regulator gate until you no longer smell the gases and the heat that comes out of the oven loading door is acceptable when you place your hand near the upper refractory portion of the door.

5.7. INSTALLING THE BURNER

Once the hole has been created in the cooking base, you can proceed to install the burner in the oven; please refer to the procedure described below for burner installation.

5.7.1. FIXING THE FLANGE WITH SLEEVE

Each flange with sleeve is customised to fit the Customer's oven, on the basis of the indications provided at the time of the order.



CAUTION!

The flange with properly installed sleeve must always stick out by about 30 mm from the cooking base surface, in order to protect the burner against potential collisions and falling material.

Each flange with sleeve is equipped with 4 fixing holes.

Under normal conditions it is possible to fix the flange to the lower part of the base using the 4 holes arranged at the corners of the flange.

STEP	ACTION
1	Insert the sleeve in the hole previously created in the base, making sure that the upper end sticks out by about 30 mm inside the cooking chamber.
2	Rotate the flange so that the studs are lined up radially with respect to the centre of the cooking chamber.
3	Secure the flange to the bottom part of the base by using the special holes. <ul style="list-style-type: none"> • use self-threading holes for plate bottoms; • use expansion plugs for masonry bottoms; • use anchors for bottoms made of hollow flat tile.

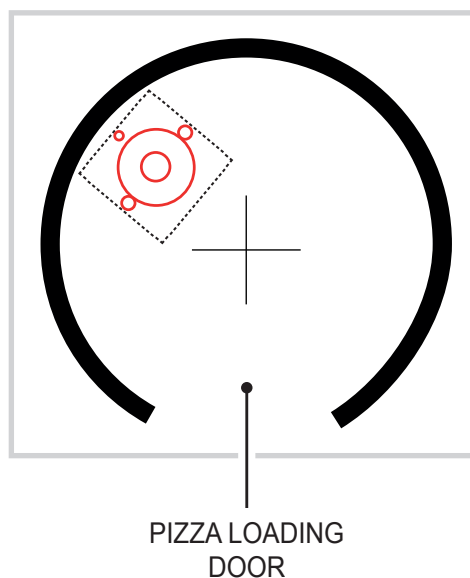

5.7.2. VERIFY POSITIONING OF THE IGNITION ELECTRODE

Before inserting the burner in the flange, check that the ignition electrode is positioned correctly.
The spark generated by the ignition electrode must discharge on the edge of the upper plate of the pilot flame.



CAUTION!

The tip of the electrode must be about 3 millimetres from the pilot plate.

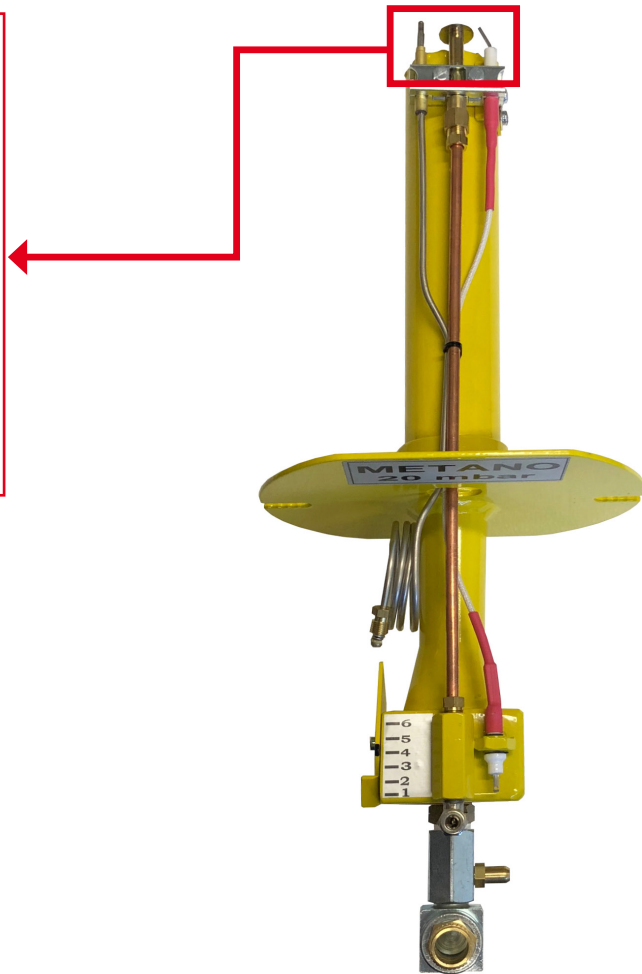
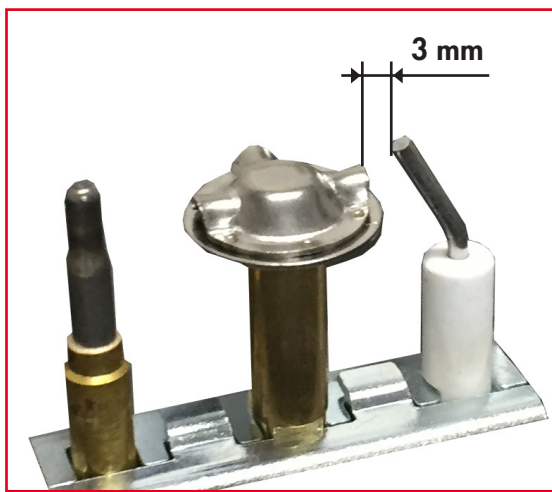

5.7.3. SECURING THE BURNER

CHAPTER 5

Each flange is supplied with coupling points for the burner, made of a spacer, wide-band washer, 8 MA stud and 8 MA nut.

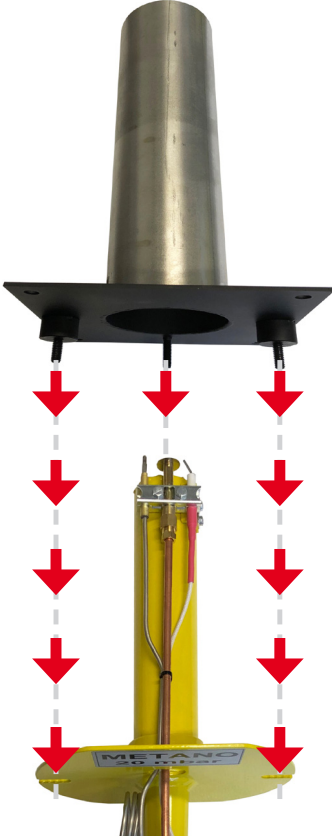
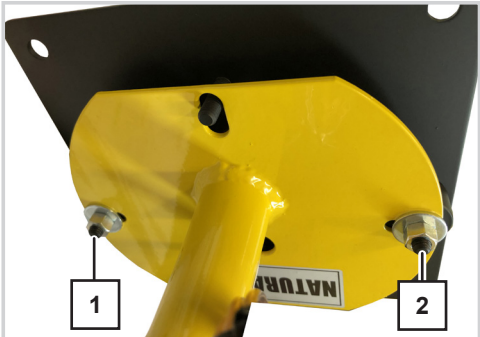
STEP	ACTION	PICTURE
1	Insert the burner into the flange with sleeve, making sure that the three studs of the flange are matched up with the burner eyelets.	
2	Secure the burner by inserting the washers and the relative nuts on the two studs "1" and "2", then proceed to tighten them.	



CAUTION!

The flange with sleeve is equipped with two lateral fixing washers and one in the rear part, so as to make the direction of insertion of the flange unique.

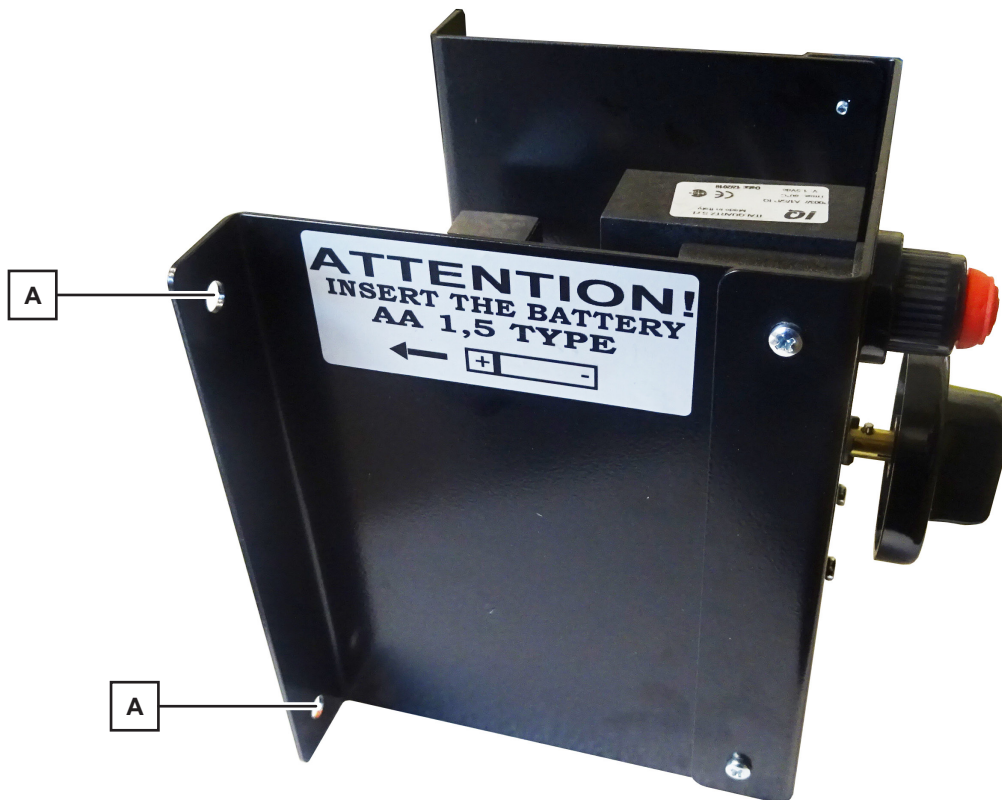

5.7.4. SECURING THE CONTROL PANEL WITH KNOB

STEP	ACTION
1	Identify the best position where to install the control panel (one ideal position is at the side of the oven loading door, since it can be easily accessed by the operator yet it is protected against potential collisions).
2	Secure the control panel using screws or plugs that are suitable for the surface in question in the 4 preset holes "A" (2 right and 2 left).

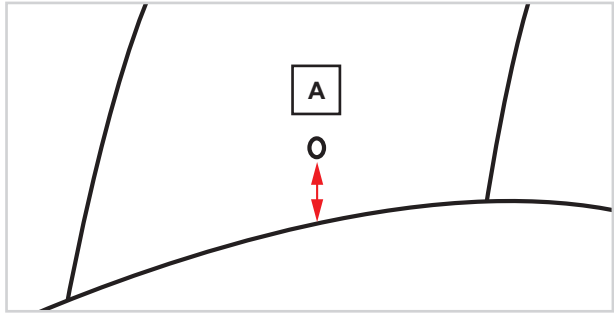

5.7.5. POSITIONING THE TEMPERATURE PROBE - OPTIONAL

Proceed as follows to position the temperature probe:

STEP	ACTION	PICTURE
1	Insert the temperature probe in the previously made hole: <ul style="list-style-type: none"> • 30-40 mm above the cooking surface (Fig. "A"). 	
2	Insert the probe so that the bulb fully enters the cooking chamber and place it parallel to the cupola, without it touching the side or the oven surface.	
3	Secure the probe wire outside the oven so that it cannot be moved accidentally.	

PAGE INTENTIONALLY LEFT BLANK

5.8. CONNECTIONS

CHAPTER 5

To start the Drago P1, secure the necessary connections:

No.	TYPE
1	1/2" GAS PIPE connection (supplied) from the control panel to the burner.

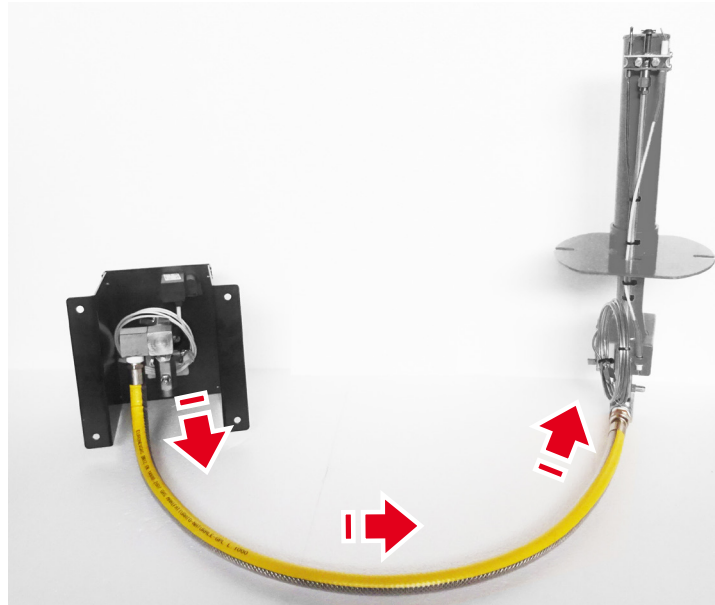

NO.	TYPE
2	THERMOCOUPLE connection from the burner to the control panel.

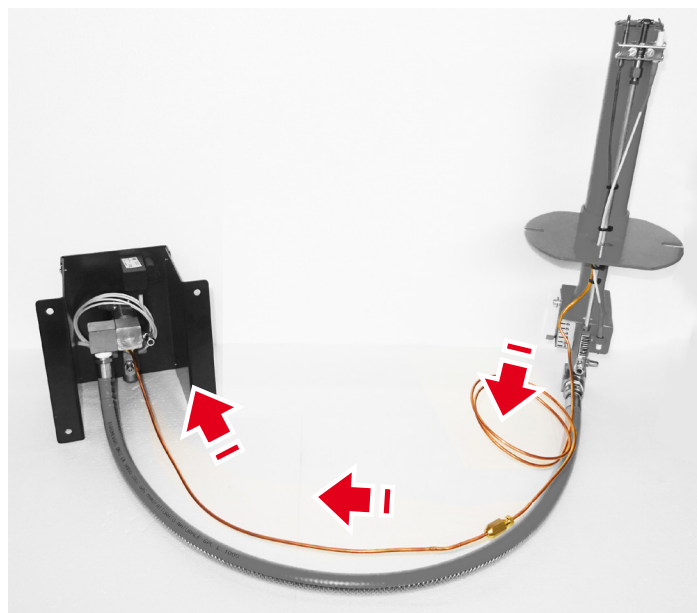

NO.	TYPE
3	Pilot flame COPPER PIPE d.6 connection (supplied) from the burner to the control panel.

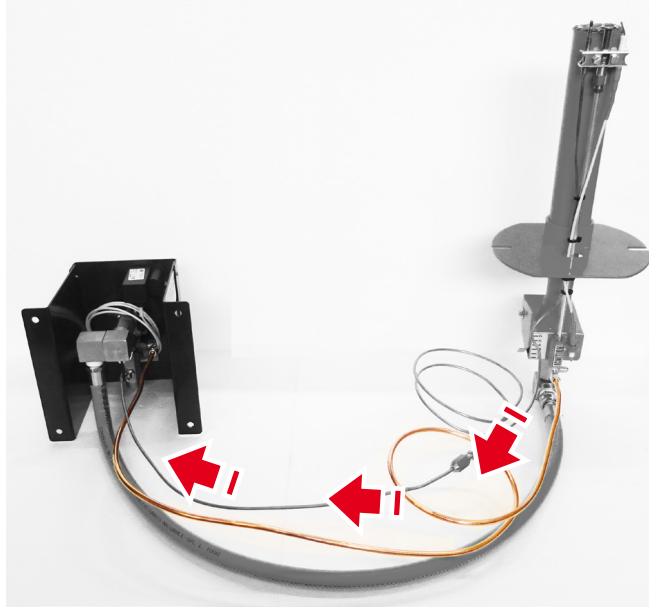

NO.	TYPE
4	IGNITION ELECTRODE connection from the control panel to the burner.

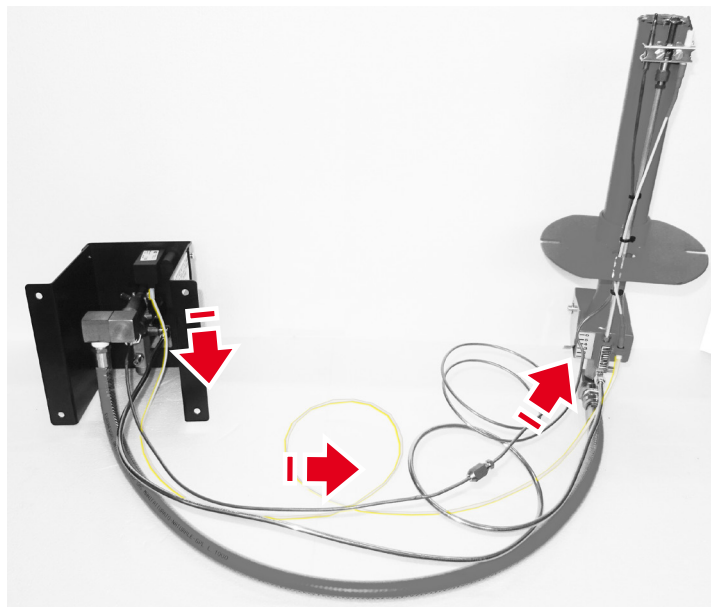

5.8.1. GAS PIPE CONNECTION FROM THE BURNER TO THE CONTROL PANEL WITH A KNOB

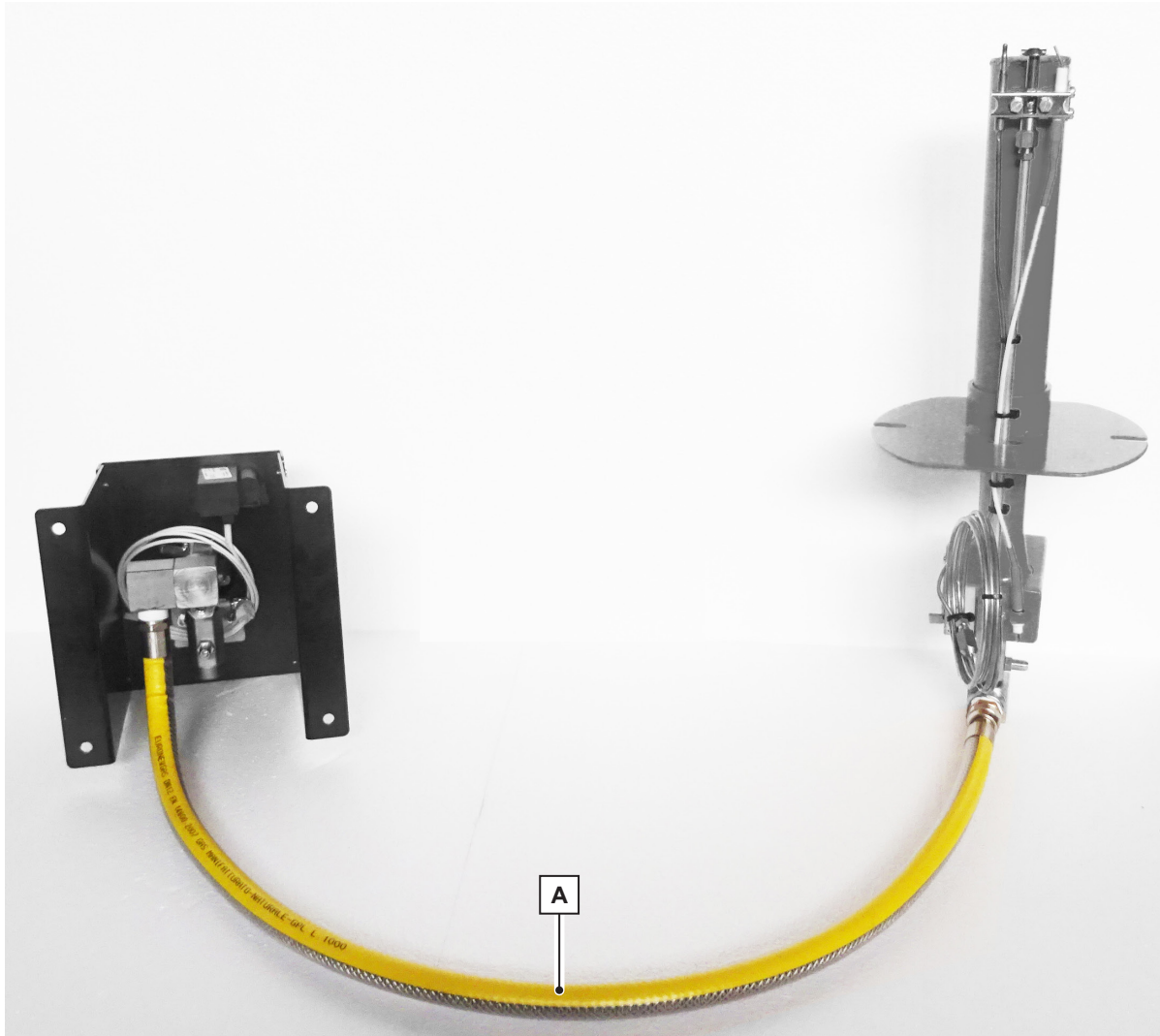

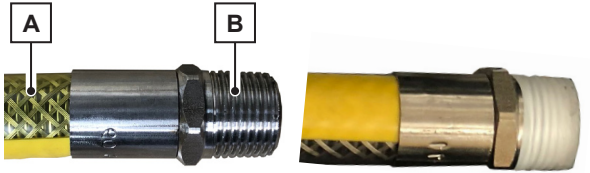
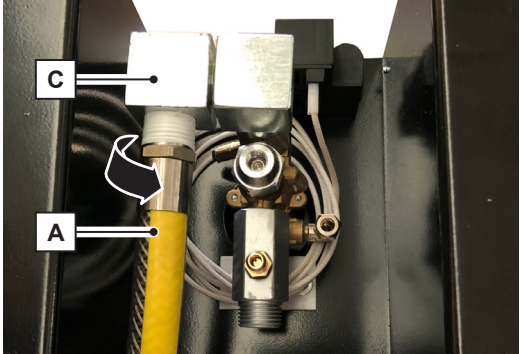
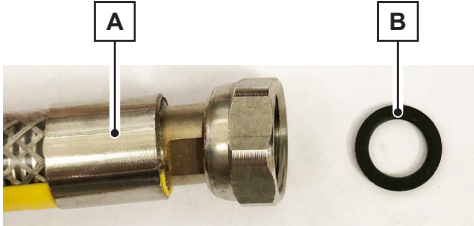
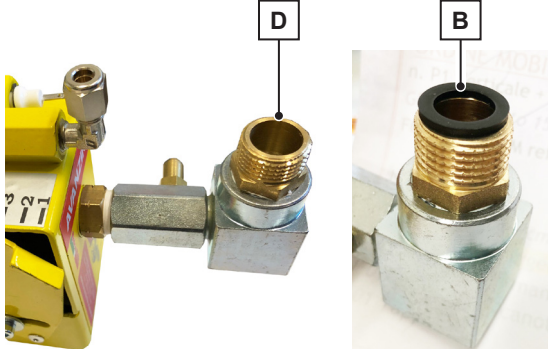
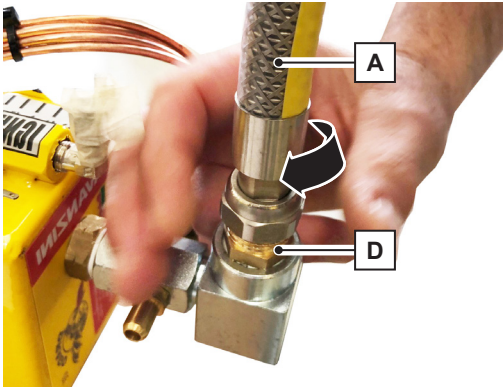

Make the connection by following the steps below:

STEP	ACTION	PICTURE
1	Take the end of the connection pipe "A" (supplied) and wrap the connection thread "B" with Teflon.	
2	Tighten the connection pipe "A" to the connection of the control panel "C" and tighten with a spanner.	
3	Take the other end of the connection pipe "A" (supplied) and its gasket "B".	
4	Place the gasket "B" on connection "D" at the base of the burner.	
5	Tighten the connection pipe "A" to the connection "D" of the burner and tighten with a spanner.	

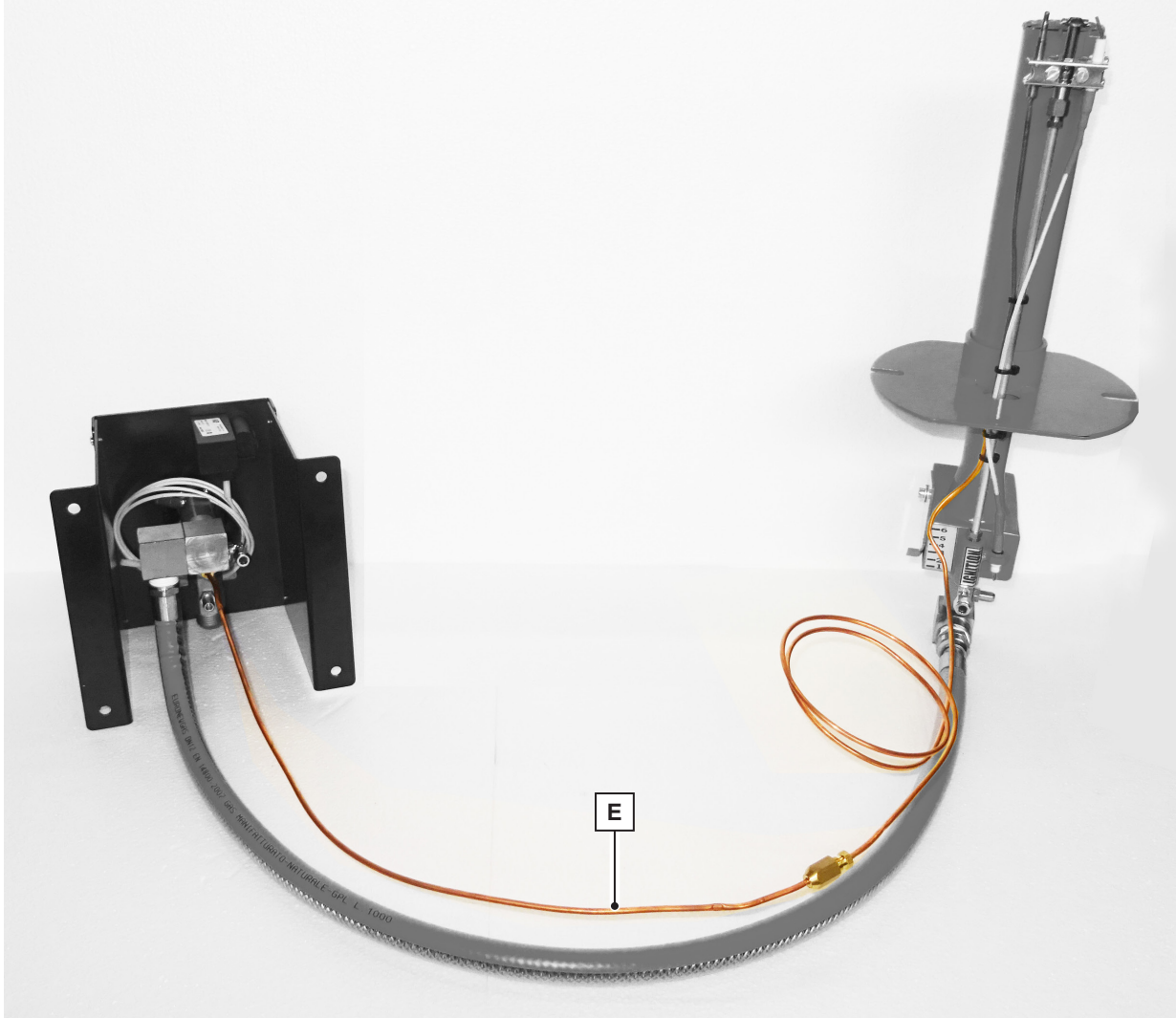
5.8.2. THERMOCOUPLE CONNECTION FROM THE BURNER TO THE CONTROL PANEL WITH A KNOB

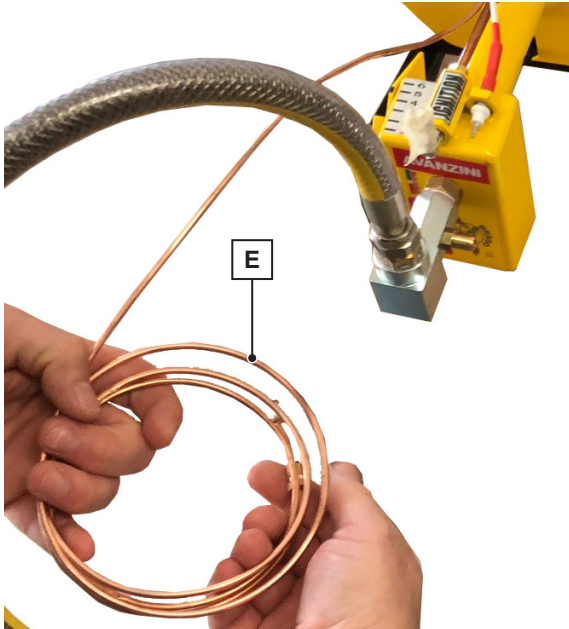

Make the connection by following the steps below:

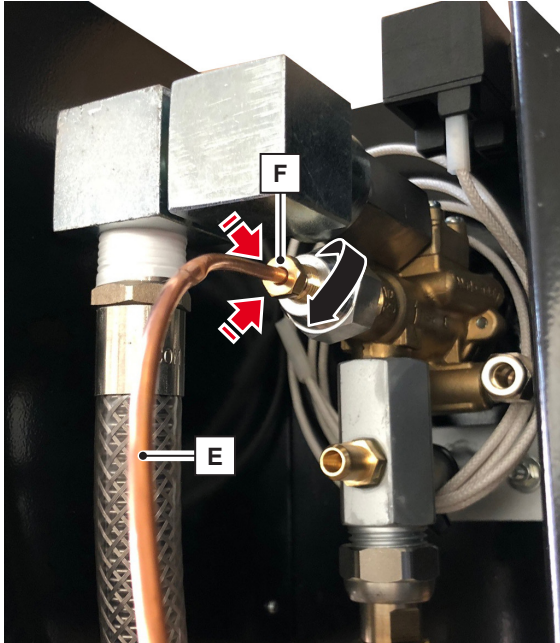
STEP	ACTION	PICTURE
<p>1</p>  <p>CAUTION! Be careful to shape the thermocouple with wide curves so as not to damage it.</p>	<p>Unroll the thermocouple "E" leaving the burner.</p>	
<p>2</p>  <p>CAUTION! Tightening the thermocouple too much could damage it.</p>	<p>Insert the screw-on end of the thermocouple "E" to the grip point "F" of the control panel, screw it by hand and tighten it gently with a spanner (9 mm) for a maximum of 1/4 of a turn.</p>	

5.8.3. COPPER PIPE (PILOT FLAME) CONNECTION FROM THE BURNER TO THE CONTROL PANEL WITH A KNOB

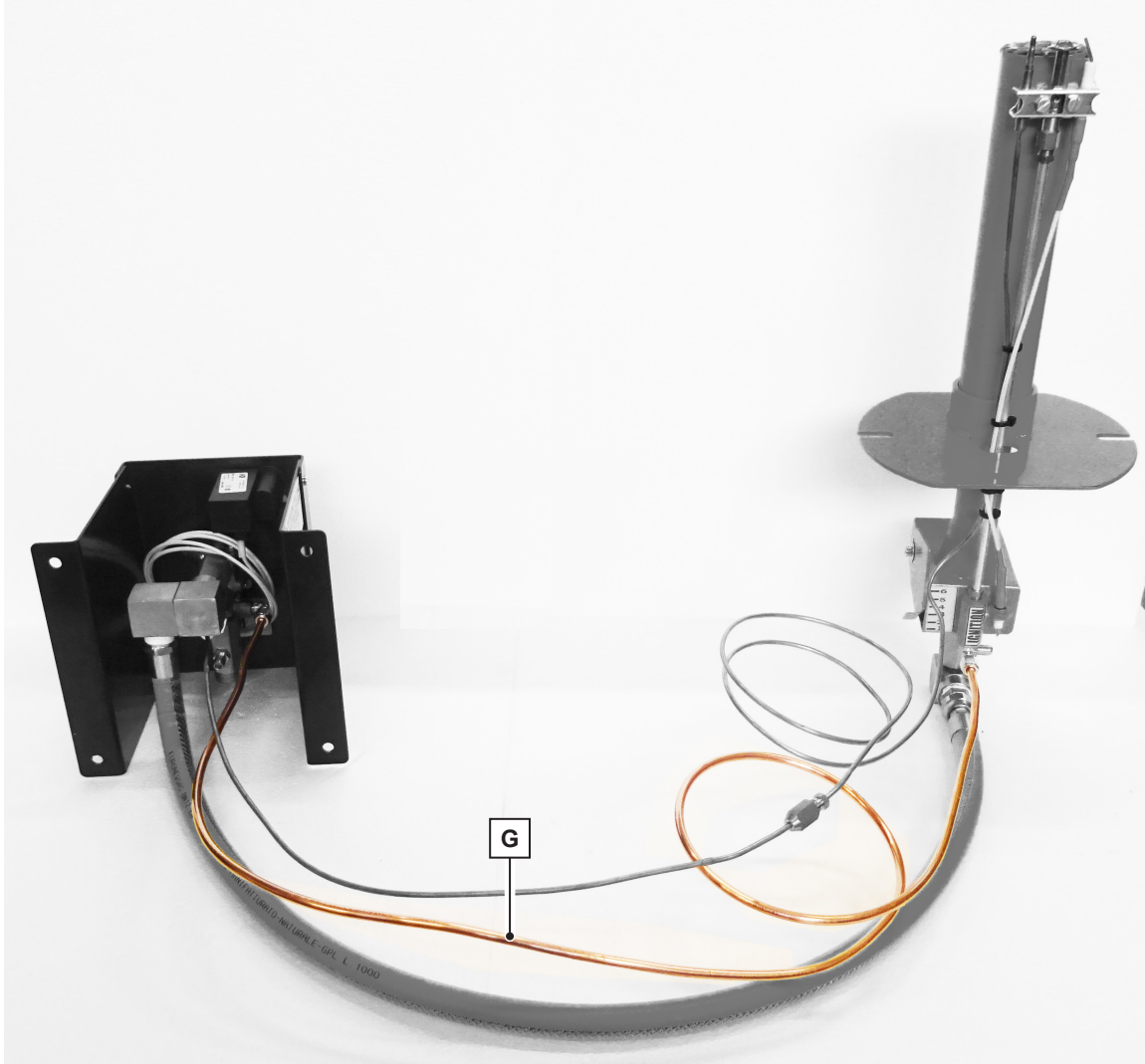

Make the connection by following the steps below:

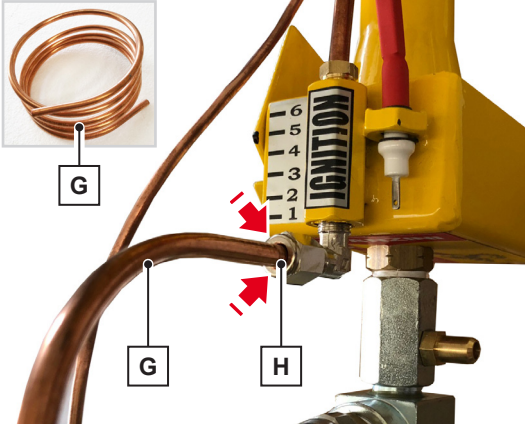
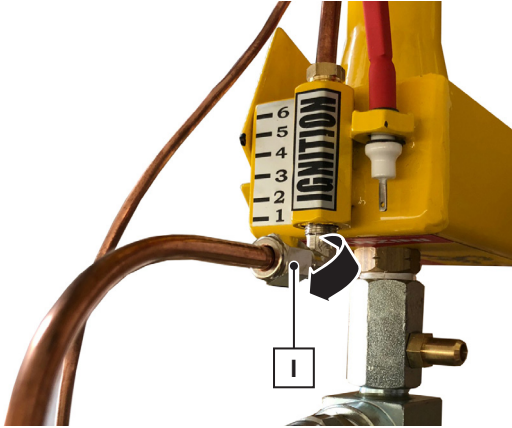
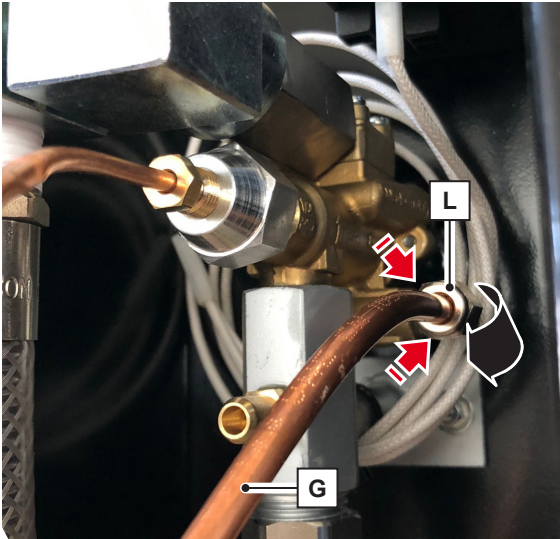
STEP	ACTION	PICTURE
<p>1</p>  <p>CAUTION! Be careful to shape the copper pipe with wide curves so as not to damage it.</p>	<p>Unroll the copper pipe "G" (supplied) and insert the end into the grip point "H" of the burner.</p>	
<p>2</p>	<p>Tighten the nut "I" of the burner until with a spanner (11 mm).</p>	
<p>3</p>	<p>Insert the other end of the copper pipe "G" into the grip point "L" of the control panel and tighten the nut with a spanner (11 mm).</p>	

5.8.4.IGNITION ELECTRODE CONNECTION FROM THE CONTROL PANEL WITH A KNOB TO THE BURNER

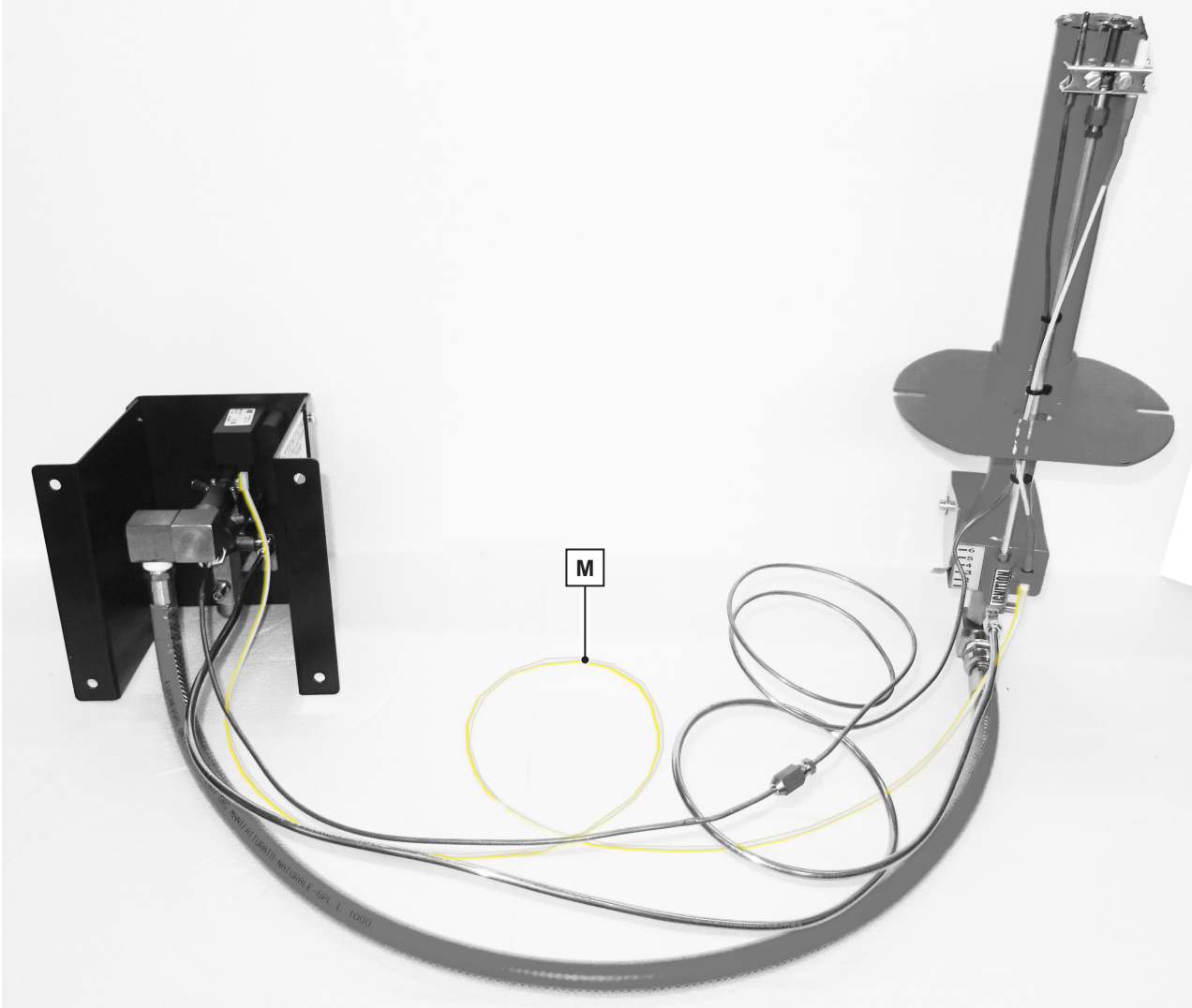

Make the connection by following the steps below:

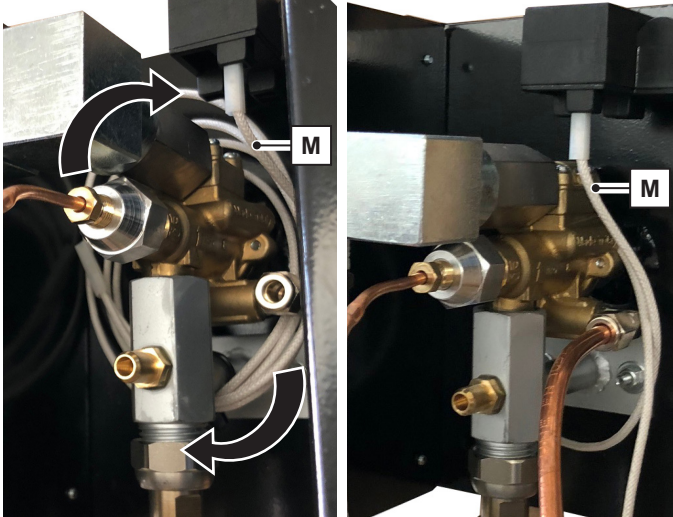
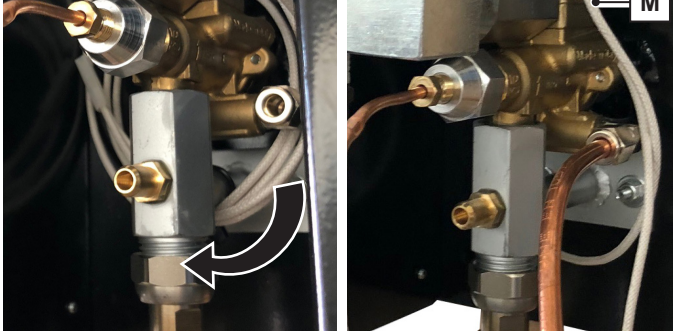
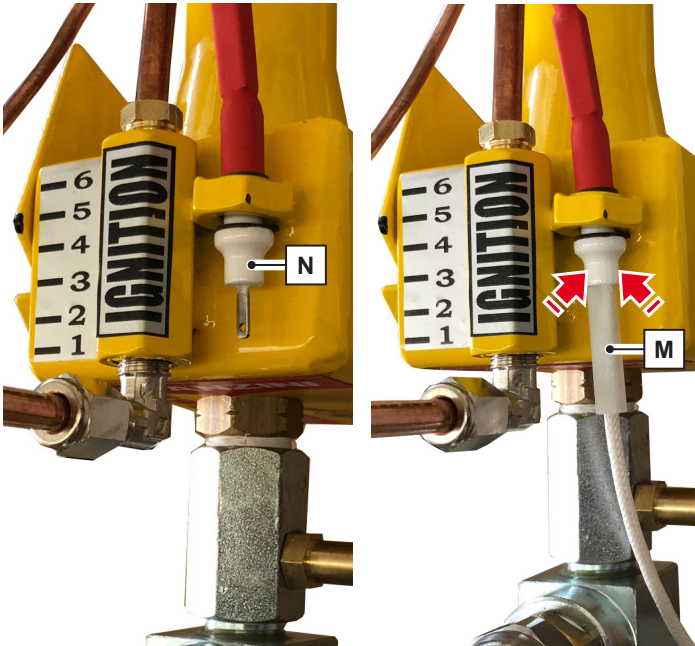
STEP	ACTION	PICTURE
1	Cut the plastic clamp that holds the cable.	
2	Completely unroll the white cable "M" leaving the control panel.	
3	<p>Insert the end of the white cable "M" into the connection point "N" of the burner.</p> <p>NOTE: If necessary, secure the cable along its path with plastic clamps, without tightening them.</p> <p>Do NOT use metal clamps that could short-circuit the electrical ignition.</p>	

5.9. CONNECTIONS

To put the machine into operation, the necessary connections to the local area network must be ensured:

- Control panel connection to the gas mains or LPG system
- NATURAL GAS connection
- LPG connection

The user is in charge of ensuring the connection characteristics required.

The machine uses gas for its own operation, and it is designed and built for the use of specific gases; please refer to the information found on the CE plate affixed to the burner in order to identify the type of gas to be used.

**CAUTION!**

Do not use the burner with gases other than the ones indicated on the CE plate. AVANZINI BRUCIATORI s.r.l. declines any and all responsibility with regards to faults resulting from the use of gases other than the ones indicated on the CE plate of the burner.

**CAUTION!**

The gas supply system must be properly designed and built, according to the regulations in force in the country of installation.

**CAUTION!**

Upstream the burner connection point, install a tap having suitable characteristics. The Customer is responsible for installing the tap.

**CAUTION!**

Connections to the gas network should be carried out by the Customer's qualified personnel.

5.9.4.1. NATURAL GAS CONNECTION

Follow the procedure below to connect to the natural gas network:

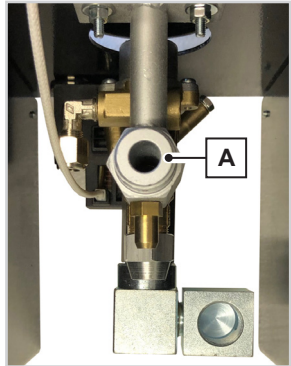
STEP	ACTION	PICTURE
1	Connect the gas supply to the 1/2" male fitting "A" on the burner with a flexible hose (not supplied).	
2	<p>Make sure the pressure is included between 17 and 23 mbar.</p> <p>CAUTION! <u>For countries with 10 mbar standard,</u> make sure the pressure is between 9 and 13 mbar.</p>	



CAUTION!

PERIODICALLY CHECK THAT THE OPERATING PRESSURE IS CORRECT.

In case of insufficient pressure, the burner may experience malfunctions or switch off.

5.9.4.2. LPG CONNECTION

Burner supply using LPG can be via:

- a tank, equipped with a high pressure reducer calibrated to 1.5 bar and low pressure reducer calibrated to 30 mbar;
- cylinders, with a capacity of at least 30 kg, equipped with a manifold with a 30 mm diameter with the following equipment: safety valve, pressure gauge, high pressure reducer APZ 12-14 Kg/h calibrated to 1.5 bar, 6 kg/h low pressure reducer calibrated to 30 mbar (visible from the special pressure gauge) and 1/2" piping.

All accessories needed for burner connection (with systems that use cylinders) are sold separately; please contact AVANZINI BRUCIATORI s.r.l. for information on how to purchase these accessories.

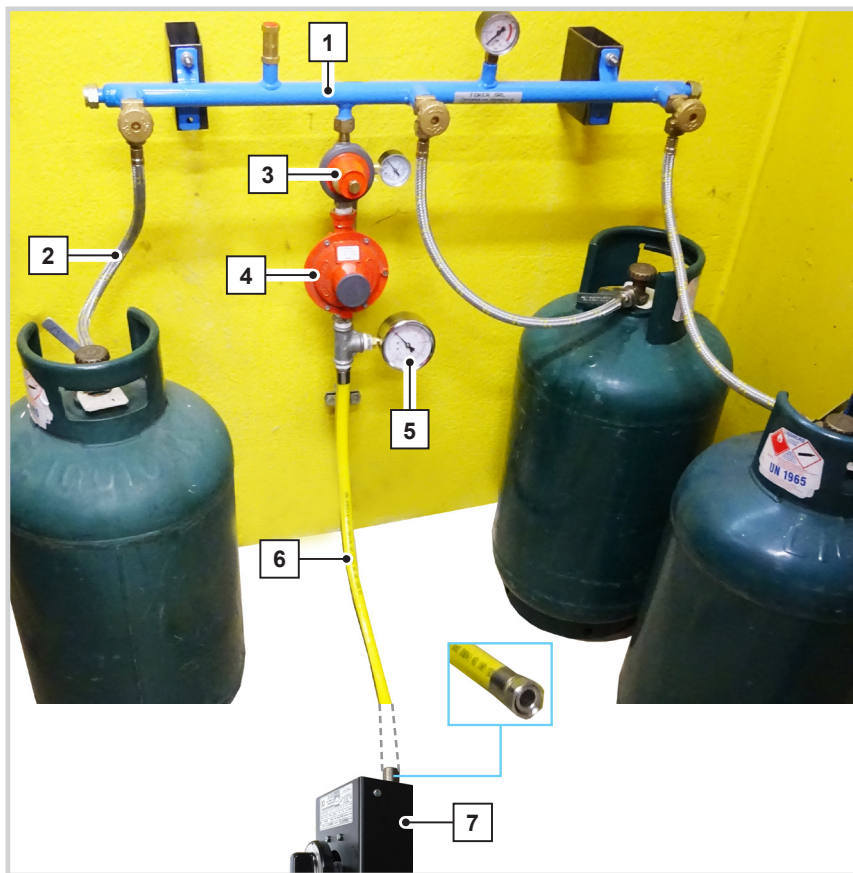

Gas ramp - LPG

1	ø30 manifold with pressure gauge and safety valve.
2	Hoses to the cylinders with Italian coupling.
3	High pressure reducer APZ 12-14 kg/h calibrated to 1.5 bar.
4	6 kg/h low pressure reducer adjusted to 30 mbar.
5	Outfeed pressure gauge.
6	1/2 fitting hose to burner.
7	Drago P1 Burner.



CAUTION!

For component No.2 (flexible hose to the cylinders), it is possible that the connections provided by us are not compatible with the cylinders that the customer is able to find locally; the customer is responsible for the cylinder connection.

5.9.1. GAS PIPE CONNECTION FROM THE CONTROL PANEL WITH A KNOB TO THE DISTRIBUTION SYSTEM

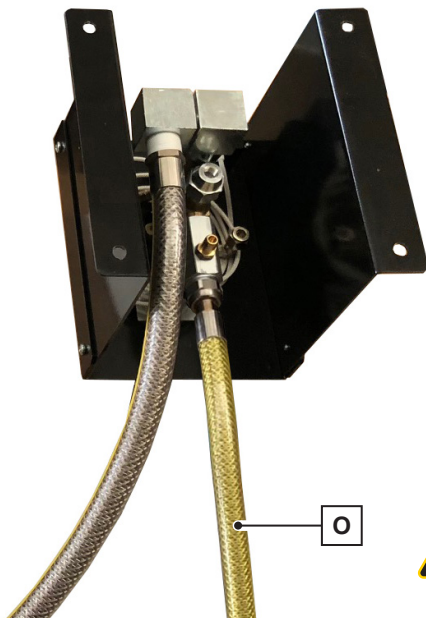

CAUTION!
PIPE NOT SUPPLIED, BUT CAN BE REQUESTED AS AN OPTIONAL ACCESSORY.

Make the connection by following the steps below:

STEP	ACTION	PICTURE
1	Take the end of the 1/2" connection pipe "O" (optional - NOT SUPPLIED) and its gasket "P".	
2	Insert the gasket "P" and tighten the 1/2" connection pipe "O" (optional - NOT SUPPLIED) to the control panel. CAUTION! The connection pipe "O" must be long enough between the control panel and the distribution system: <ul style="list-style-type: none"> • min: 50 cm; • max: 200 cm. 	

5.9.1.1. VERIFYING THE SUPPLY PRESSURE

Below is the procedure to check the supply pressure to the burner:

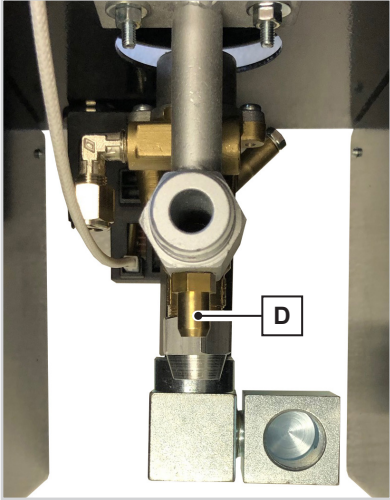
STEP	ACTION	PICTURE
1	Identify the connection point of the pressure gauge in the bottom part of the control panel (pressure inlet).	
2	Loosen the screw cap "D" inside the pressure inlet.	
3	Connect a pressure gauge (not supplied) to the pressure inlet.	
4	Measure the supply pressure with the burner off.	
5	Open the gas valve and read the pressure at the pressure gauge.	
6	Close the gas valve and check that the pressure at the pressure gauge does not drop.	
7	Leave the piping pressurised for 10 minutes and check again that the pressure at the pressure gauge has not dropped. If the pressure drops, this is an indication of a gas leak.	
8	If the pressure has remained stable, open the gas valve again.	
9	Disconnect the pressure gauge from the connection point.	
10	Tighten the screw cap "D" inside the connection point of the pressure gauge.	

The gas supply counter must possess the following minimum requirements:

MINIMUM REQUIREMENTS OF THE NATURAL GAS COUNTER	
DOMESTIC USE	3 m ³
INDUSTRIAL USE	6 m ³

5.10. DISMANTLING AND WASTE DISPOSAL



CAUTION!

Decommissioning and dismantling operations must be entrusted to personnel specialised in such activities. In particular, only those in charge of the dismantling and final waste disposal phase can perform the following activities:

- mechanical and electrical disconnection of parts according to disassembly instructions and design diagrams.
- transporting parts from the plant to the waste disposal facility for separation of parts.

The following operations as well as indications in the manuals of the equipment, machines, partly-completed machinery and components used, supplied by AVANZINI BRUCIATORI s.r.l. as an integral part of the instructions and warning manual, must be taken into consideration for decommissioning.

The machine essentially consists of the following materials:

- painted, plasticised or galvanised ferritic steel;
- stainless steel series 300/400;
- plastic polyethylene material;
- elastomers, PTFE, graphite;
- electric cables with relative gaiters;
- electronic control and actuation devices.
- etc.



IMPORTANT!

The machine does not contain components or hazardous substances which require special removal procedures.

The person in charge of dismantling and waste disposal operates on the whole machine only and exclusively when removing and disposing of the machinery at the end of its life.

Follow the procedure below to perform decommissioning, dismantling and removal of the machine at the end of its operational life. The following operations as well as indications in the manuals of the equipment, machines, partly-completed machinery and components used, supplied by AVANZINI BRUCIATORI s.r.l. as an integral part of the instructions and warning manual, must be taken into consideration for decommissioning purposes.

STEP	ACTION
1	Leave enough space around the machine so that the personnel is able to carry out the movements without any risks, arranging for appropriate equipment.
2	Disconnect all energy sources using the power cut-off devices and lock them in the open position (refer to the wiring diagram for additional information).
3	Disconnect the power cable from the cut-off device (first detach the power conductors and then the earth conductors).
4	Disassemble the machine from the top downwards, paying special attention to the machine units subject to falling by gravity and all parts which could have product residue.
5	As far as possible, separate the various components by type of materials, which must be disposed of through separate waste collection. Have the materials resulting from demolition disposed of by specific companies.
6	Remove the various parts of the machine from the work area.



IMPORTANT!

After having disassembled the machine according to the previous disassembly procedure, the various materials must be segregated in compliance with standards of the country where the machine must be eliminated.



Pursuant to the 2012/19/EU "WEEE" DIRECTIVE, if the purchased component/equipment is marked with the following crossed-out wheeled bin symbol, it means that the product must be collected separately from other waste at the end of its lifespan.



IMPORTANT!

We remind you to comply with the laws in force regarding the disposal of processing residue.

6. HOW TO USE

During machine work phases the operator in charge must run the machine in constant respect of the safety devices foreseen, by checking:

- the correct positioning of the safety devices;
- the correct operation of the safety devices;
- compliance with personal safety standards.





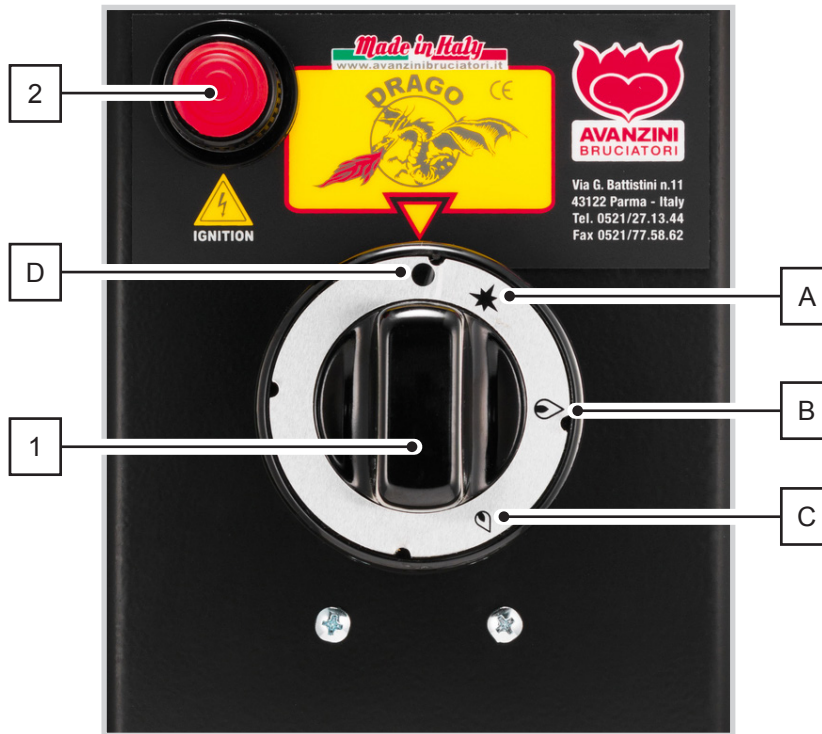

Make sure that the work cycle runs efficiently, ensuring maximum productivity, by checking:

- the integrity and functionality of the main parts of the machine;
- the wear status of work equipment in order to avoid interruptions in the work cycle;
- that the work parameters are the optimal ones for the type of material and processing to be executed;
- the homogeneity of all the material prepared for processing.

6.1. CONTROL PANEL WITH KNOB DRAGO P1

All burner functions can be managed from the Drago P1 control panel, as can be seen below.



POS.	ICON/BUTTON	DESCRIPTION
1		Flame adjustment selector
2		Pilot flame ignition button
A		Pilot flame
B		High flame
C		Low flame
D		Switching off

6.2. FIRST IGNITION AND ADJUSTMENT

Prior to switching on the burner, make sure the oven loading door is open.

**CAUTION!**

Before starting the first ignition, check that the type of gas used matches that indicated on the CE plate of the burner and, if required, proceed with the burner conversion, as described in paragraph 7.5.

**CAUTION!**

THE OVEN LOADING DOOR MUST ALWAYS BE OPENED BEFORE SWITCHING ON THE BURNER, AND IT MUST STAY COMPLETELY OPEN FOR THE ENTIRE TIME THE BURNER IS SWITCHED ON.

**CAUTION!**

If present, make sure you remove the protective optional steel plug, which is used during wood-burning oven operation and is positioned above the burner.

6.2.1. FIRST IGNITION WITH THE CONTROLS OF THE CONTROL PANEL



IMPORTANT!

Open the oven loading door prior to switching on the burner.



FIRST IGNITION

For the first ignition procedure, follow the operations described below:

STEP	ACTION	PICTURE
1	Rotate the control knob and keep it pressed on the ignition position "1", while pressing the button "A" until the pilot flame ignites.	
2	Release the button "A", while continuing to press the control knob for another 30" after the pilot flame ignites.	
3	Release the control knob and the burner must remain on only with the pilot flame.	
4	Move the control knob from the ignition position "1" to the large flame position "2".	
5	Keep the control knob on the large flame position "2" until the desired temperature is reached.	
6	Check the temperature by moving the control knob, if necessary, from the large flame position "2" to the small flame position "3".	

CAUTION!



The first ignition may be difficult as it takes some time to let out all the air in the copper pipe that feeds the pilot.

You must persist until all three flames have been lit on the pilot head for the main burner to ignite properly.

6.2.2. HIGH FLAME ADJUSTMENT



IMPORTANT!

All burners are adjusted by our technicians before being shipped.
To change the factory settings, carry out the procedure described below.

For the high flame adjustment procedure, carry out the operations described below:

STEP	ACTION	PICTURE
1	Press and rotate the selection knob anti-clockwise.	
2	Set the selection knob on the "HIGH FLAME" symbol.	
3	Extract the knob "A" by grasping it with your fingers and pulling it firmly outwards.	
4	Adjust the height of the high flame by actuating the screw "B": <ul style="list-style-type: none"> tighten to reduce the flame; The correct flow rate is obtained when the flame reaches the centre of the oven cupola.	

STEP	ACTION	PICTURE
5	Check the flame colour in connection with the air flow. See paragraph 6.2.4	
6	Once the flame adjustment procedure is completed, refit the knob "A".	



IMPORTANT!

The HIGH FLAME is preset – use the knob to vary the heat required according to the product that is to be cooked.



IMPORTANT!

The colour of the flame indicates the air - gas mixing ratio.
A light blue flame indicates that there is too much oxygen.
A yellow flame indicates that there is not enough oxygen.



6.2.3. LOW FLAME ADJUSTMENT



IMPORTANT!

All burners are adjusted by our technicians before being shipped.
To change the factory settings, carry out the procedure described below.

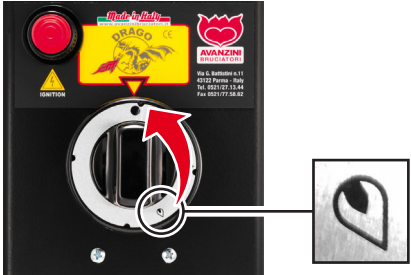
For the low flame adjustment procedure, carry out the operations described below:

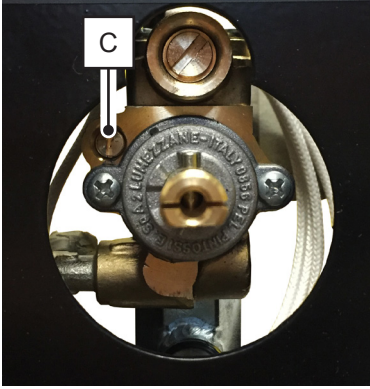
STEP	ACTION	PICTURE
1	Press and rotate the selection knob anti-clockwise.	
2	Set the selection knob on the "LOW FLAME" symbol.	
3	Extract the knob "A" by grasping it with your fingers and pulling it firmly outwards.	
4	Adjust the height of the high flame by actuating the screw "C". The flow rate is correct when the flame touches the cupola and the empty oven does not increase in degrees.	

STEP	ACTION	PICTURE
5	<p>Check the flame colour in connection with the air flow.</p> <p>The flame must be soft, silent and yellow, but it must not colour the cupola of the oven:</p> <ul style="list-style-type: none"> • Methane: open the damper to position 3.5/4. • LPG: open the damper to position 5.5/6. 	
6	<p>Once the flame adjustment procedure is completed, refit the knob "A".</p>	



IMPORTANT!

The LOW FLAME is preset – use the knob to vary the heat required according to the product that is to be cooked.



IMPORTANT!

The colour of the flame indicates the air - gas mixing ratio.
 A light blue flame indicates that there is too much oxygen.
 A yellow flame indicates that there is not enough oxygen.

6.2.4. FLAME AIR ADJUSTMENT



IMPORTANT!

All burners are adjusted by our technicians before being shipped.
To change the factory settings, carry out the procedure described here below.

For the flame air adjustment, follow the procedure below:

STEP	ACTION	PICTURE
1	The burner must be on.	
2	Loosen the hex socket "1" on the air flow adjustment bulkhead of the flame	
3	Manually operate on partition "2" until the desired air flow is obtained. See paragraph 6.2.3 step 5.	
4	Check the flame colour in connection with the air flow. NOTE: the flame must be blue at the base and yellow at the tip, just enough to illuminate the oven, but without forming soot (flame too yellow).	



IMPORTANT!

The colour of the flame indicates the air - gas mixing ratio.
A light blue flame indicates that there is too much oxygen.
A yellow flame indicates that there is not enough oxygen.

6.2.5. SWITCH-OFF WHILE MAINTAINING THE PILOT FLAME

Follow the procedure below to switch off the cooking flame, while keeping the pilot flame on for a subsequent restart:

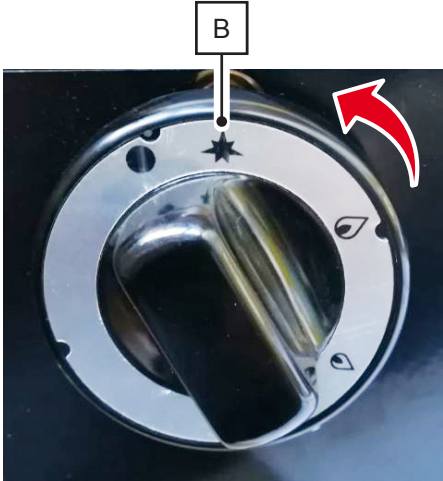
STEP	ACTION	PICTURE
1	Rotate the control knob to "B".	

6.2.6. SWITCHING OFF THE BURNER

No special procedures are required to switch off the burner as this does not require any particular conditions.

Switch off the burner as follows:

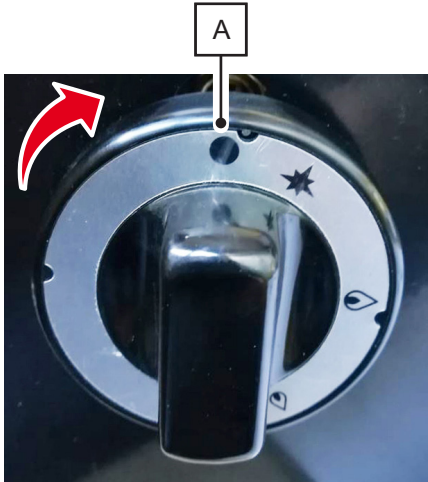
STEP	ACTION	PICTURE
1	Rotate the control knob to the switch-on position "A".	
2	Close the gas supply valve.	
3	Apply the oven closure nozzle.	

7. MAINTENANCE

7.1. INTRODUCTION



CAUTION!

The maintenance operations must be carried out by qualified and authorised personnel.

Burner maintenance includes activities (inspection, check, adjustment and replacement) that become necessary following regular use of the burner.

For proper maintenance operations:

- Only use original spare parts, suitable tools for the purpose and in good status.
- Respect the frequency of intervention indicated in the scheduled maintenance (preventive and periodic) manual. The distance (indicated in time or in working cycles) between operations has to be understood as the maximum acceptable, so it must not be exceeded; however, it can be shortened.
- Good preventive maintenance requires constant attention and continuous monitoring of the burner. Check immediately the cause of any abnormalities such as excessive noise, overheating, fluid leakage, etc. and solve it.
- A timely removal of the any causes of anomaly or malfunctioning avoids further damaging the equipment and guarantees operator safety.

In case of doubt, it is forbidden to operate. Contact the Manufacturer for the necessary clarification.

The personnel in charge of burner maintenance must be properly trained and possess in-depth knowledge of safety standards; unauthorised personnel must stay outside the work area during operations.

The machine cleaning and adjustment operations are also carried out only and exclusively during the maintenance phase and with the burner off.

From an operational point of view, the machine maintenance operations are divided into two main categories:

<p>MAINTENANCE MAINTENANCE</p>	<p>All those operations that the operator must preemptively perform to guarantee proper operation of the burner over time; routine maintenance includes inspection, checks, adjustment, cleaning and lubrication.</p>
<p>EXTRAORDINARY MAINTENANCE</p>	<p>All the operations the operator must perform the moment the burner requires it. Extraordinary maintenance includes service, repair, restoration of nominal operating conditions or replacement of a faulty, defective or worn unit.</p>

7.2. SAFETY WARNINGS



CAUTION!

For the maintenance activities, close the gas supply system.

- Maintenance operators are required to wear all of the personal protective equipment (gloves, goggles) necessary to perform the operation.
- During maintenance operations, unauthorised staff must stay out of the relative operating area.
- If the operation entails removing protections, set barriers up around the area and display signs forbidding access to anyone who is not directly involved in the maintenance work.

The need to place the burner under operating conditions and/or with the protections disabled, requires an adequate competence and knowledge and extreme caution by the maintenance engineer that must be adequately trained on possible and existing risks.

The safety precautions in this paragraph must always be strictly observed, during maintenance of the machine to avoid injuries to personnel and damage to the equipment:

- Before proceeding with any maintenance activities, check that the energy sources are disconnected.
- Only perform the interventions with the machine stopped and de-energised.
- Padlock the gas supply tap.
- He must be able to use the most suitable and adequate instruments to find the fault and know the most suitable equipment for the maintenance interventions.

To perform certain maintenance operations, it could be necessary that the protections and safety devices be deactivated and the guards open. In that case, operators are in hazardous conditions and the following rules must be strictly respected:



CAUTION!

Maintenance personnel must be authorised and specifically instructed regarding the safety and operating procedures to be followed, the danger situations which could arise and the correct methods to avoid them.



IMPORTANT!

During these operations, personnel must pay the utmost attention and operate with extreme caution.

7.3. ROUTINE MAINTENANCE

When the burner is delivered to the user, it is already adjusted for correct operation; nonetheless, to ensure good operation over time, it is necessary to carry out checks as well as periodic and preventive maintenance.

Routine maintenance includes inspections, checks and interventions that, in order to prevent faults, monitor:

- the mechanical status of the equipment,
- the lubrication of the machine,
- machine cleanliness.

The following tables list a series of controls and activities that need to be carried out according to the recommended frequency. The frequency of the routine maintenance activities listed here refer to normal operating conditions, i.e. that fulfil the required operating conditions.

7.3.1. ROUTINE MAINTENANCE TABLE

OPERATION	FREQUENCY			
	Daily	1 month	2 months	6 months
Visually check the integrity of all the machine's protective devices.	♦			
Visually check the wear and cleanliness conditions.	♦			
Check the proper operation of the electrical trigger.			♦	
Check the proper tightening of the gas fittings.			♦	
Check the wear of the insulation (connection cables, connectors).		♦		
Check the fastening devices of the protections.		♦		
Check adjustment operation.		♦		

7.3.2. MACHINE CLEANING



CAUTION!

Before starting any cleaning operation on the machine, isolate and padlock all energy sources and safely lock the mobile units composing it. Affix the sign "Machine being serviced - do not power" near the main switch.

IT IS FORBIDDEN for cleaning personnel to remove the guards and protection devices on the machine.



CAUTION!

Prior to starting any cleaning operation on the machine, you need to wait for the components to cool down (about 40 minutes).

Perform the cleaning cycle according to the following intervals:

FREQUENCY	TYPE OF INTERVENTION
Daily	<ul style="list-style-type: none"> • Clean the machine parts in contact with the inside of the oven. • Manual removal of product residues.
Monthly	<ul style="list-style-type: none"> • Clean the entire machine on the inside and on the outside.

7.4. EXTRAORDINARY MAINTENANCE



CAUTION!

Extraordinary maintenance and repair of the machine are only allowed by qualified, trained and | authorised technicians, employed by the Manufacturer or by the authorised service centre. These procedures require a thorough and specialist knowledge of equipment, necessary operations, related risks and correct procedures to work safely.

The interventions not included among those listed under "routine maintenance" are considered "extraordinary maintenance" interventions.

Should any exceptional circumstances occur, for which extraordinary maintenance is necessary, the user's maintenance operators are required to follow this procedure:

- perform the operations described in the paragraph "Extraordinary Maintenance";
- if the operations to be executed are not provided for in this manual, send the Manufacturer a report of the event occurred, along with the outcome of the inspection and any comments.

The Manufacturer or the authorised service centre will consider the situation on a case-by-case basis.

They will then agree with the routine maintenance engineers the type of procedure to be performed, choosing the most suitable solution among those listed below:

- the Manufacturer sends its skilled technician, who is trained and authorised to perform the necessary operations;
- or the Manufacturer authorises the user's maintenance operators to perform the procedures, providing any additional instructions.

CAUTION!

The spare parts to be replaced are to be ordered from AVANZINI BRUCIATORI s.r.l.



Should the customer not use genuine spare parts or parts authorised in writing by the Manufacturer, the latter shall be relieved of any liability as regards machine operation and operators' safety.

Authorisation and/or instructions must always be given in writing. It is forbidden to operate the machine without written permission and the Manufacturer disclaims any and all responsibility.

7.5. BURNER GAS CONVERSION



CAUTION!

The conversion operation requires the purchase of the special conversion kit, which contains a nozzle; contact AVANZINI BRUCIATORI s.r.l. to obtain all information on how to purchase the conversion kit;

7.5.1. NOZZLE COMPOSITION

Below are the main components of the nozzle:

POS.	DESCRIPTION
A	<u>NOZZLE</u> NOTE: the nozzle can be replaced as needed.
B	<u>HEX STUD BOLT</u> 13mm spanner. NOTE: the stud bolt must NOT be replaced.
C	<u>STUD BOLT</u> fitting

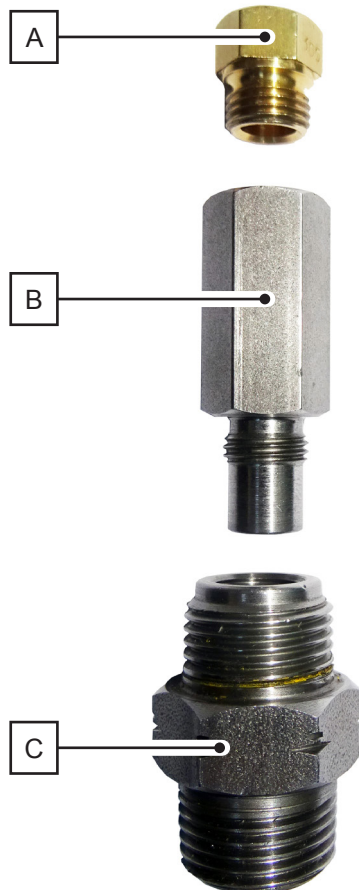

7.5.2. NOZZLE REPLACEMENT

For the gas nozzles replacement procedure, carry out the operations described below:

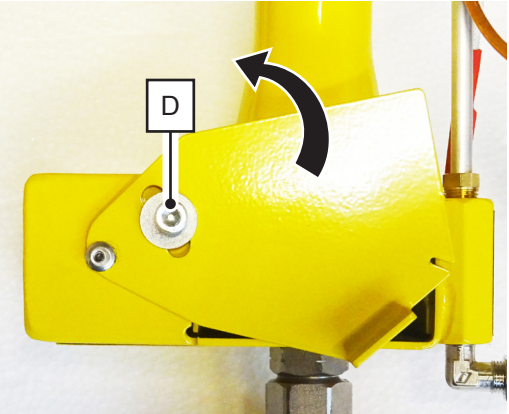
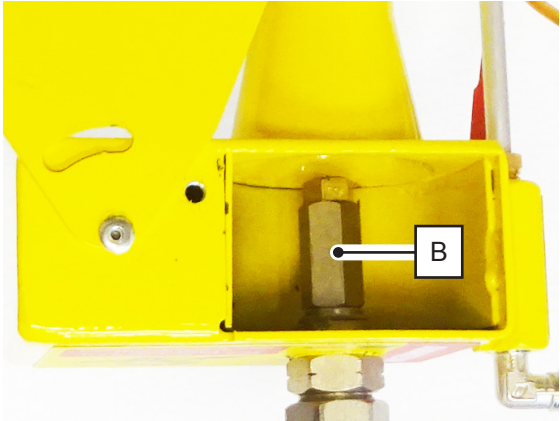
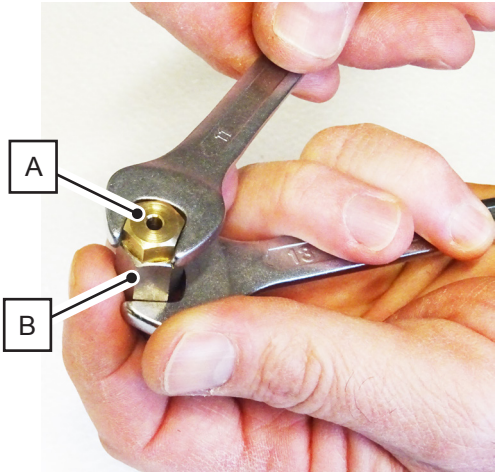
STEP	ACTION	PICTURE
1	Use a $\varnothing 4$ mm spanner to loosen and remove screw "D" to fully open the partition.	
2	Use a 13 mm spanner to dismantle the stud bolt "B" and remove it from the burner.	
3	Use an 11 mm spanner to unscrew nozzle "A" from stud bolt "B", and replace the nozzle required for the type of gas.	

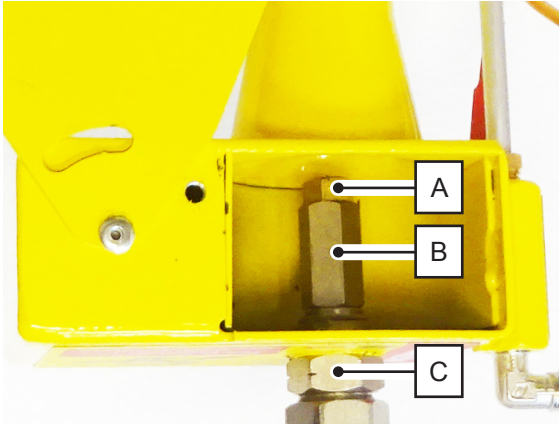
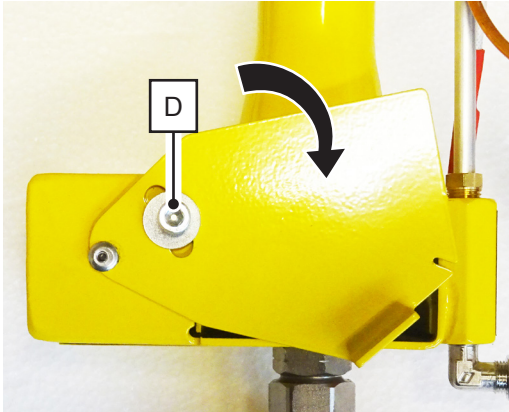
STEP	ACTION	PICTURE
4	Fasten stud bolt "B" and nozzle "A" to fitting "C".	
5	Tighten screw "D" again to fasten the partition.	

CHARACTERISTICS OF ALTERNATIVE NOZZLES	
NOZZLES FOR METHANE GAS 20 mbar: Nozzle diameter 3.25 millimetres	GAS PRESSURE: <ul style="list-style-type: none"> with burner on, minimum 13 mbar, maximum 20 mbar; with burner off, minimum 17 mbar, maximum 23 mbar.
NOZZLES FOR LPG 30 mbar: Nozzle diameter 2.25 millimetres	GAS PRESSURE: <ul style="list-style-type: none"> with burner on, minimum 25 mbar, maximum 45 mbar; with burner off, minimum 30 mbar, maximum 50 mbar.
NOZZLES FOR NATURAL GAS 10 mbar: Nozzle diameter 3.75 millimetres	GAS PRESSURE: <ul style="list-style-type: none"> with burner off, minimum 9 mbar, maximum 13 mbar.

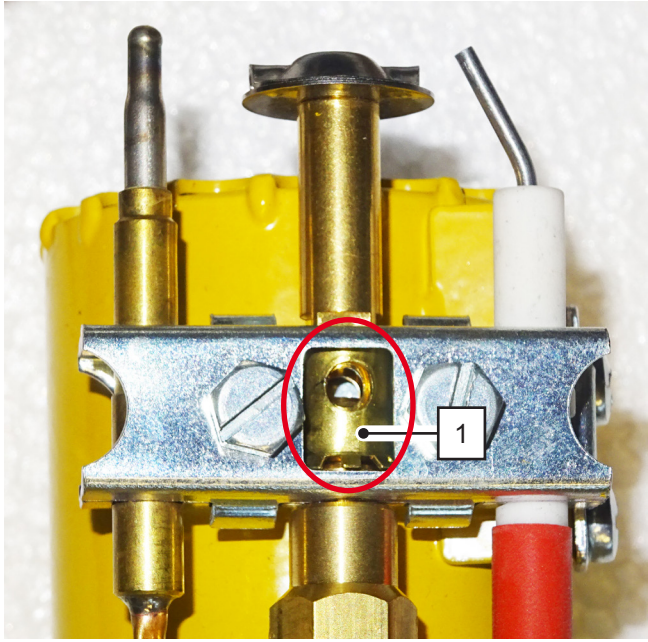
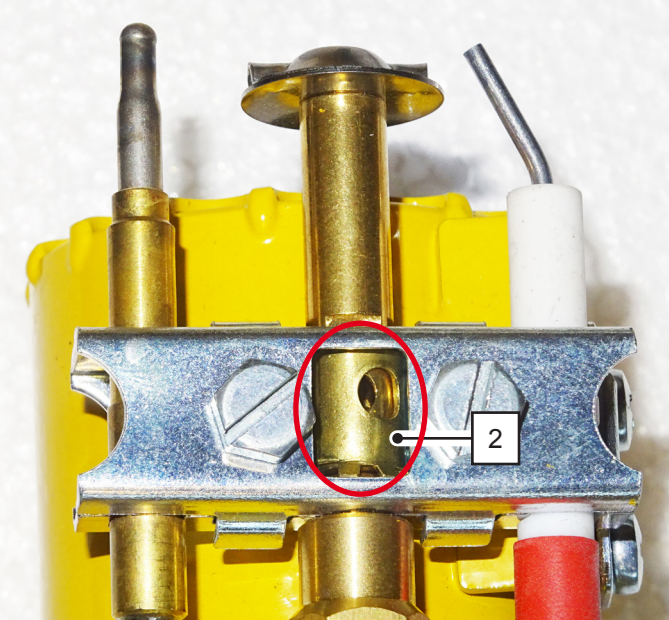

7.5.3.PILOT FLAME AIR ADJUSTMENT

in case of conversion to natural gas or LPG, adjust the pilot flame air as shown below:

POS	TYPE	PICTURE
1	<p>OPEN LPG SUPPLY</p>	
2	<p>1/2 CLOSED NATURAL GAS SUPPLY</p>	

7.5.4. REPLACEMENT SWITCH-ON BATTERY

For the ignition battery replacement procedure, carry out the operations described below:

STEP	ACTION	PICTURE
1	Unscrew and remove the power button "A".	
2	Remove the old battery and insert a new battery in the compartment "B", complying with the polarity.	
3	Tighten the button "A".	
4	Dispose of the replaced battery correctly.	

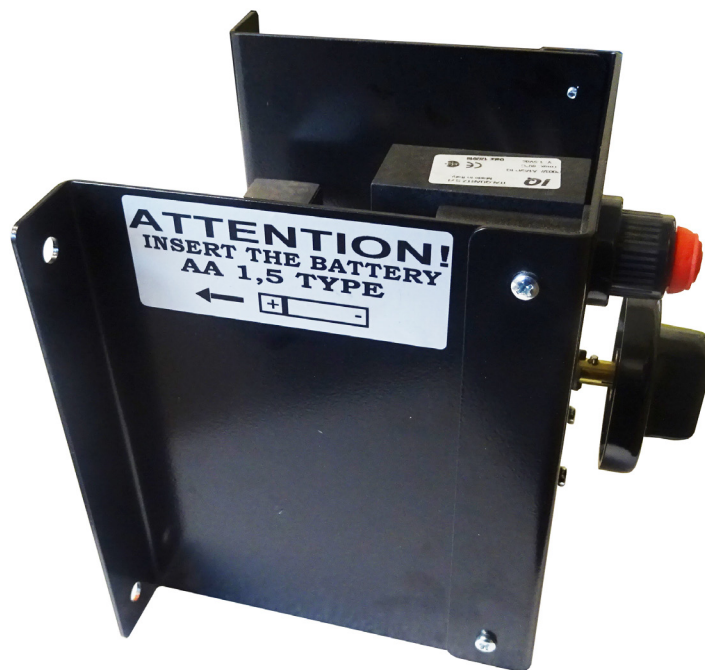

NOTE!
For an AA 1.5 V battery as the new one.

8. TROUBLESHOOTING

8.1. INTRODUCTION



CAUTION!

ALL TROUBLESHOOTING OPERATIONS MUST BE CARRIED OUT WITH THE BURNER SWITCHED OFF.

PROBLEM	CAUSE	SOLUTION
<p>THE START BUTTON IS PRESSED ON THE CONTROL PANEL BUT THE BURNER DOES NOT START.</p> <p>The spark does not strike.</p>	<ul style="list-style-type: none"> Flat batteries under the start button. 	<ul style="list-style-type: none"> Replace the batteries (see par. 7.5.3); Check that the spark does not disperse along the path of the white wire.
<p>THE SPARK STRIKES BUT THE FLAME DOES NOT IGNITE</p>		<ul style="list-style-type: none"> Check that all the gas system valves between the burner and counter are open, including the safety solenoid valves. <p>Disassemble the burner and:</p> <ul style="list-style-type: none"> Clean it: turn it over and, if necessary, blow compressed air from the air intake and flame breaker. Check that the white power cable is intact. Check the integrity and correct positioning of the ignition electrode; if cracked, order a spare kit and replace the electrode. Eventually, order a new pilot flame assembly and replace it.

PROBLEM	CAUSE	SOLUTION
<p>THE PILOT FLAME DOES NOT REMAIN ON</p>		<ul style="list-style-type: none"> • Purge the copper pipe that brings the gas to the pilot flame. • Check the integrity of the thermocouple and replace it if necessary. • Check that the thermocouple connections are tight enough.
<p>SLOWER HEATING THAN THE NORMAL PARAMETERS: if the oven takes longer than normal to reach the temperature (about 1.30/2 hours).</p>		<ul style="list-style-type: none"> • Make sure that the burner is delivering the correct kilocalories by reading the meter or looking at the flame, making sure that it reaches at least the centre of the cupola. Correct it if necessary by adjusting the flame adjustment screw on the valve (see par. 6.2.2 - 6.2.3). • Make sure your plant, meter and cross-section of the pipe are sized correctly in relation to the length. • Make sure there are no pressure drops when the burners of the hob, deep fryer, hot water and heating boilers and kitchen ovens are started up.
<p>TOO MUCH FLAME IN THE BAKING CHAMBER: if the pizza toppings tend to burn and/or the flame visually goes beyond the centre of the cupola.</p>		<ul style="list-style-type: none"> • Slowly adjust the height of the flame so that it reaches approximately the centre of the cupola (see par. 6.2.2 - 6.2.3).

PROBLEM	CAUSE	SOLUTION
<p>SOOT ON THE CUPOLA</p>		<ul style="list-style-type: none"> • Burner (air/gas ratio) not properly adjusted (less air). • Unsuitable environment (proper ventilation suction). • Chimney dirty/closed. • Burner under the oven without oxygen. • Cleaning of the flue in case of conversion of wood-burning oven. • Repeat the phases of the first ignition, paying special attention to the air and gas settings. • Room ventilation check. • Spacer washers are missing between the burner and the flange sleeve • Burner compartment with special opening. • In case of suction in the room: you will need to size the air intake of the room in addition to the air burned by the burner, and also take into account the air extracted by the hook.

8.2. MANUFACTURER'S ADVICE

COMBINED USE OF WOOD + GAS

With this solution the traditional wood-burning aspect is maintained; wood does not change either the taste or the smell of the product

- no cap.
- partition between wood and burner: brick laid on its side.
- wood position in front of the burner; in terms of the door, keep an eye on the wood, not on the wood pile. Clean the ashes on a daily basis.

REQUIREMENTS FOR A COMBINED USE SYSTEM

The flue dimensions and materials must be suitable for the combined wood-plus-gas operation.

Use of the system with wood leads to a significant change in the system, with more stringent regulations that must be complied with.

If the oven is suited for wood-burning operation, it is also suited for gas operation. The opposite, however, is not true. In case of flue suited for wood-burning operation, when switching to gas it is recommended to fit a draught adjustment gate in order to obtain the right consumption and consequently perfect oven operation.

- Switch on the burner, the wood will soon catch fire spontaneously.
- On the contrary of what happens with gas operation only (oven reaches the set R° , the burner does not maintain a constant T°), T° continues to increase for 1F+ wood; the burner is likely to be switched off manually using the switch towards the end of the night or as needed. Management of burner on-off-on.
- Cover the oven loading door.
- Prior to restarting operation, empty out the ashes and put in more wood.

9. ATTACHMENTS

This chapter contains the documentation enclosed with the line.

The enclosed documentation constitutes an integral part of the "INSTRUCTIONS, USE AND MAINTENANCE MANUAL" of the machine supplied by AVANZINI BRUCIATORI s.r.l.. It must be used as a reference for the use, operation and maintenance of the equipment and components.

9.1. TECHNICAL DATA SHEET

MODEL	THERMAL OUTPUT			
	<i>in Kw</i>		<i>in Kcal/h</i>	
	MIN	MAX	MIN	MAX
Drago P1 METHANE GAS	6	15	5.160	12.900
Drago P1 LPG	6	15	5.160	12.900

MODEL	PRESSURE OF GAS		CONNECTION GAS	WEIGHT
	<i>in mbar</i>			
	MIN	MAX		
Drago P1 METHANE GAS	10	25	1/2"	7
Drago P1 LPG	25	50	1/2"	7



Updated on: 10/2022

AVANZINI BRUCIATORI s.r.l.
Via G. Battistini, 11
43122 - Parma (PR) - Italy
tel. +39 0521 271344
info@avanzinibruciatori.it
www.avanzinibruciatori.it