

FIRST ALERT

Onelink[®]

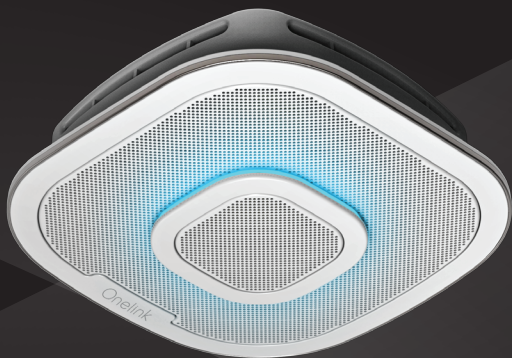

SAFE & SOUND



User's Manual

Important! Please Read Carefully And Save This Document. This User's Manual contains important information about your combination smoke and CO alarm's operation. If you are installing this alarm for use by others, you must leave this manual (or a copy of it) with the end user.

NOTE: See Safe & Sound ID and Pairing Code Label on back cover of User's Manual.



FIRST ALERT

Onelink[®]



SAFE & SOUND

User's Manual Model: 1039102

Installed On _____

Replace By _____

Table of Contents

Welcome	4 - 5
Parts of This Alarm	5
Smoke & Carbon Monoxide Alarm	6
Where to Install	7
Where Not to Install	8
Setup and Installation	9 - 13
When the Alarm Sounds	14
Using the Silence Feature	15
Factory Reset	15
Weekly Testing	16
Regular Maintenance	17
Alarm End of Life	17
Ionization and Photoelectric Technology	18
Fire Safety Tips	18 - 19
What You Need to Know About CO	20
Potential Sources of CO in the Home	21 - 22
Regulatory Information	23 - 25
Special Compliance	26 - 27
General Limitations	27 - 28
Troubleshooting Guide	29
Limited Warranty	30
Copyright and Technical Specifications	31

Welcome

Welcome to your Onelink Safe & Sound alarm. Thank you for choosing Onelink by First Alert for your safety needs. In addition to the alarm sounds, you can receive notifications in case of an emergency to help provide a warning of a fire or carbon monoxide while you are home or away. Please take time to read this manual and make this alarm an integral part of your family's safety plan. Visit onelink.firstalert.com for additional information.

Amazon Alexa

Alexa is built in the cloud, so it is always getting smarter. The more you use Alexa, the more Alexa adapts to your speech patterns, vocabulary, and preferences with new features continually being added. Ask Alexa to answer questions, play music, hear the news, get weather and traffic reports, control your smart home, and more.

Contents



Onelink Safe & Sound



Mounting Bracket

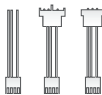

Power Connector / Adapter Plugs



Junction Box Screws



User's Manual



Alexa Quick Start Guide

System Requirements



Wireless Network

Required to use a 2.4 GHz wireless connection and a compatible 802.11 b/g/n/ac router.



Android or iOS Device

You can use your Onelink Safe & Sound with Android 5 or later and with iOS 10 or later.



Onelink Home App

Search and download the Onelink Home app from the App Store or Google Play.

Parts of this Alarm

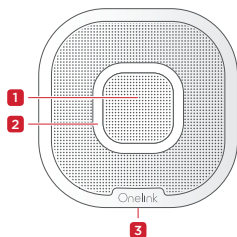

1.	Speaker
2.	Color Indicator Ring
3.	Test/Silence Button (on the side of the product)

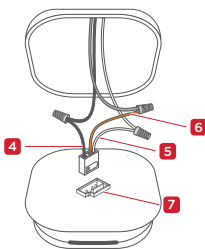

4.	Hot (black) AC Wire
5.	Neutral (white) AC Wire
6.	Interconnect (orange) AC Wire
7.	Quick Connect Power Connector

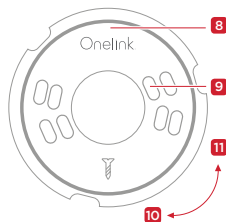

8.	Mounting Bracket
9.	Mounting Slots
10.	Turn Alarm Clockwise on Bracket to Attach
11.	Turn Alarm Counter Clockwise to Remove from Bracket

Smoke & Carbon Monoxide Alarm

LED Color Patterns	Smoke / CO Events	Voice Guide
 Multicolored	Power Up	Power Up
	Programming, Silencing & Pairing	"[Location, example: "Hallway"] Location saved."
	Testing	"The testing is complete." [Test Complete - interchanging to next test/Safe & Sound out of alarm mode]
 White	Welcome	Hello and welcome to your Onelink Safe & Sound. Download the Onelink Home App through the App Store or Google Play. The app will walk you through the process.
	Power Indicator and Night Light	N/A
 Blue	Pairing	N/A
	Testing	"This is only a test. The alarm will sound and for your protection is very loud. The test will start in 5 seconds. 5...4...3...2...1."
 Green	Power Indicator when Night Light is Off	N/A
 Red	Testing	"Testing smoke" [beep beep beep!]
		"Testing carbon monoxide" [beep beep beep beep!]
		"Evacuate, evacuate, there's fire in the [Location]!"
		"Highest carbon monoxide level was 0 PPM."
	Emergency	"Evacuate! Evacuate! There is smoke [or carbon monoxide] in the [Location]!" "Highest carbon monoxide level was [Number] PPM."
 Yellow	Malfunction	"Error, please see users manual or contact customer service." "Alarm has reached its end of life. Replace your alarm."
	Low Battery	N/A
	Main Alexa Color Patterns For When You Are Using Alexa On Your Safe & Sound	
 Blue Cyan	Solid Blue with Cyan	Alexa is busy processing your request. The device is starting up.
 Red White	Half Red	Mute: You have turned off the microphones on your device [tone]. *Note: Two (2) LEDs will remain red while the device is muted.

Where to Install

Minimum coverage for smoke alarms, as recommended by the National Fire Protection Association (NFPA), is one smoke alarm on every level, and in every bedroom (See "Regulatory Information For Smoke Alarms" for details on the NFPA recommendations). For CO alarms, the National Fire Protection Association (NFPA) recommends that CO alarms be installed on every level and in the central location outside each bedroom. For added protection, install additional CO alarms in every bedroom.

NOTE: For added protection, install an additional smoke/CO alarm at least 20 feet (6 meters) away from the furnace or fuel burning heat source where possible. In smaller homes or in manufactured homes where this distance cannot be maintained, install the alarm as far away as possible from the furnace or other fuel burning source. Installing the alarm closer than 20 feet (6 meters) will not harm the alarm, but may increase the frequency of unwanted alarms.

In General, Install Combination Smoke and Carbon Monoxide Alarms:

- On every level of your home, including finished attics and basements.
- Inside every bedroom, especially if people sleep with the door partly or completely closed.
- In the hall near every sleeping area. If your home has multiple sleeping areas, install a unit at each end. In each. If a hall is more than 40 feet (12 meters) long, install a unit at each end.
- At the top of first-to-second floor stairs.
- At the bottom of the basement stairs.
- For additional coverage, install alarms in all rooms, halls, and storage areas, where temperatures normally remain between 40° F and 100° F (4.4° C and 37.8° C).

Recommended Placement

- **Ceiling installation only:** Place the alarm as close to the center as possible.
- See Avoiding "Dead Air" Spaces for more information.

NOTE: For any location, make sure no door or other obstruction could keep carbon monoxide or smoke from reaching the alarm.

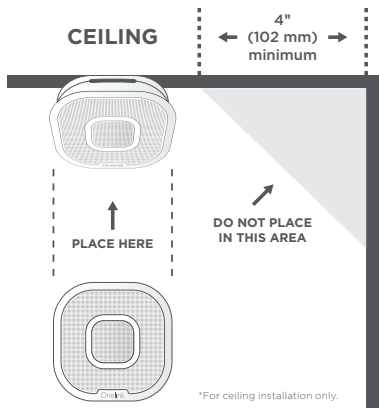

Where Not to Install

Do Not Place Your Smoke & CO Alarm:

- In garages, furnace rooms, crawl spaces and unfinished attics. Avoid extremely dusty, dirty or greasy areas.
- Where combustion particles are produced. Combustion particles form when something burns. Areas to avoid include poorly ventilated kitchens, garages, and furnace rooms. Keep units at least 20 feet (6 meters) from the sources of combustion particles (stove, furnace, water heater, space heater) if possible. In areas where a 20 foot (6 meter) distance is not possible - in modular, mobile, or smaller homes, for example - it is recommended the smoke alarm be placed as far from these fuel-burning sources as possible. The placement recommendations are intended to keep these alarms at a reasonable distance from a fuel-burning source, and thus reduce "unwanted" alarms. Unwanted alarms can occur if a smoke alarm is placed directly next to a fuel-burning source. Ventilate these areas as much as possible.
- Within 5 feet (1.5 meters) of any cooking appliance. In air streams near kitchens. Air currents can draw cooking smoke into the smoke sensor and cause unwanted alarms.
- In extremely humid areas. This alarm should be at least 10 feet (3 meters) from a shower, sauna, humidifier, vaporizer, dishwasher, laundry room, utility room, or other source of high humidity.
- In direct sunlight.
- In turbulent air, near ceiling fans or open windows. Blowing air may prevent CO/smoke from reaching the sensors.
- In areas where temperature is colder than 40° F (4.4°C) or hotter than 100° F (37.8°C). These areas include non air conditioned crawl spaces, unfinished attics, uninsulated or poorly insulated ceilings, porches, and garages.
- In insect infested areas. Insects can clog the openings to sensing chamber.
- Less than 12 inches (305 mm) away from fluorescent lights. Electrical "noise" can interfere with the sensor.
- In "dead air" spaces. See below for additional information.
- On walls.

Setup & Installation



DANGER: ELECTRICAL SHOCK HAZARD. Turn off power to the area where you will install this unit at the circuit breaker or fuse box before beginning installation. Failure to turn off the power before installation may result in serious electrical shock, injury or death.



WARNING: Make sure the alarm is not receiving excessively noisy power. Examples of noisy power could be major appliances on the same circuit, power from a generator or solar power, light dimmer on the same circuit or mounted near fluorescent lighting. Excessively noisy power may cause damage to your alarm.



WARNING: Installation of this unit must conform to the electrical codes in your area; Article 760 of NFPA 70 (NEC), NFPA 72, NFPA 101; SBC (SBCCI); UBC (ICBO); NBC (BOCA); OTFDC (CABO), and any other local or building codes that may apply. Wiring and installation must be performed by a licensed electrician. Failure to follow these guidelines may result in injury or property damage. This unit must be powered by a 24-hour, 120VAC pure sine wave 60Hz circuit. Be sure the circuit cannot be turned off by a switch, dimmer, or ground fault circuit interrupter. Failure to connect this unit to a 24-hour circuit may prevent it from providing constant protection.

Tools You Will Need:

- Needle-nose pliers or utility knife
- Wire strippers
- Standard phillips screwdriver
- Ladder

Before you begin, ensure the Android device is updated to 5 or later and iOS device is updated to iOS 10.0 or later, then download the free Onelink Home App from the App Store or Google Play and follow the installation and setup instructions.

NOTE: You must enable iCloud Keychain to use Onelink Safe & Sound on an iOS device. On your iOS device, tap Settings > [your name] > iCloud, tap Keychain and slide to turn on iCloud Keychain, follow onscreen instructions.

This smoke/CO alarm is designed to be mounted on any standard wiring junction box up to a 4-inch (10 cm) size, on the ceiling. Read "Where to Install" and "Where Not to Install" before you begin installation.

Setup & Installation (Continued)

Installing the Mounting Bracket

- Step 1** Turn off power.
- Step 2** Remove existing alarm and mounting bracket (if necessary).
- Step 3** Attach the Onelink mounting bracket to the junction box.



WARNING: Improper wiring of the power connector or the wiring leading to the power connector will cause damage to the alarm and may lead to a non-functioning alarm.

Stand-Alone Alarm Only:

- Connect the white wire on the power connector to the neutral wire in the junction box.
- Connect the black wire on the power connector to the hot wire in the junction box.
- Tuck the orange wire inside the junction box. It is used for interconnect only.

Interconnected Units Only:

NOTE: Visit www.firstalert.com/product/safe-sound to view alarms compatible with Onelink Safe & Sound.

Strip off about 1/2" (12 mm) of the plastic coating on the orange wire on the power connector.

- Connect the white wire on the power connector to the neutral wire in the junction box.
- Connect the black wire on the power connector to the hot wire in the junction box.
- Connect the orange wire on the power connector to the interconnect wire in the junction box. Repeat for each unit you are interconnecting. Never connect the hot or neutral wires in the junction box to the orange interconnect wire. Never cross hot and neutral wires between alarms.

Setup & Installation (Continued)

Installing Power Connectors

If replacing an existing First Alert alarm and the power connector is in good working condition skip to the "Installing Onelink Safe & Sound" instructions.

If installing the First Alert power connector:



Step 1 Using wire nuts, connect the white wire on the power connector to the neutral wire in the junction box, connect the black wire on the power connector to the hot wire in the junction box, connect the orange wire on the power connector to the interconnect wire in the junction box, you will need to splice the orange casing off before connecting.

Step 2 Move to the "Installing Onelink Safe & Sound" instructions.

If replacing a non-First Alert alarm use one of the other adapters supplied with the unit:



Step 1 Connect the black end of the appropriate adapter plug supplied with the unit to the existing power connector.

NOTE: There may not be enough room for the Adapter Plug and additional wiring to fit in the junction box. If not, the old power connector must be removed and replaced with the First Alert Power Connector.

Step 2 Move to the "Installing Onelink Safe & Sound" instructions.

Setup & Installation (Continued)

Installing Onelink Safe & Sound

Step 1 Connect the power connector to the First Alert® alarm.

Step 2 Check all connections. Make sure all plugs are completely connected and snapped together. Ensure the Adapter Plug is securely connected to the existing Power Connector.

NOTE: If you need to remove the power connector, turn **POWER OFF** first. Insert a flat screwdriver blade between the power connector and the security tab inside the power input block. Gently pry back the tab and pull the connector free.

Step 3 Line up the tabs on the unit with the notches on the mounting bracket.

Step 4 Install the base of the alarm to the mounting bracket, apply firm pressure, and turn clockwise until a single, non-repeating audible chirp is heard.

Stand-Alone Alarm Only:

- If you are only installing one smoke alarm, restore power to the junction box.

Interconnected Units Only:

- If you are interconnecting multiple smoke alarms, repeat steps 1-5 for each smoke alarm in the series. When you are finished, restore power to the junction box.

Step 5 Restore power to the junction box.

NOTE: After you activate the alarm for the first time, the Color Indicator Ring will power up and the alarm will welcome you. To program your alarm, follow the instructions provided in the Onelink Home App.

Step 6 Test each alarm. Press and hold the test button until the unit alarms. When testing a series of interconnected units you must test each unit individually. Make sure all units alarm when each one is tested.

NOTE: Removing the alarm from the mounting bracket will turn the alarm off.



IMPORTANT: If your alarm is not fully affixed to the mounting bracket the alarm will produce a repeating audible chirp.

Visit www.firstalert.com/product/safe-sound to view alarms compatible with Onelink Safe & Sound.

Interconnected Units Must Meet All of the Following Requirements:

- A maximum of 12 compatible units may be interconnected (Maximum of 12 smoke alarms).
- The same fuse or circuit breaker must power all interconnected units.
- The total length of wire interconnecting the units should be less than 1000 feet (300 meters). This type of wire is commonly available at Hardware and Electrical Supply stores.
- All wiring must conform to all local electrical codes and NFPA 70 (NEC). Refer to NFPA 72, NFPA 101, and/or your local building code for further connection requirements.



DANGER: If any unit in the series does not alarm, **TURN OFF POWER** and recheck connections. **RESTORE POWER.** If any unit within interconnected alarms does not alarm, replace it immediately.

Setup & Installation (Continued)

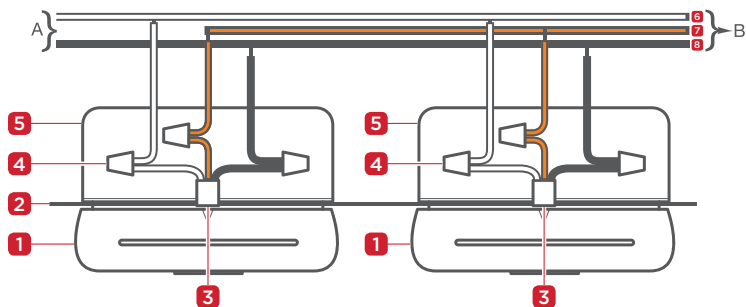

1. Smoke/CO Alarm	5. Junction Box
2. Ceiling	6. Neutral Wire (white)
3. Power Connector	7. Interconnect Wire (orange)
4. Wire Nut	8. Hot Wire (black)



WARNING: Android and iOS device notifications require a functional Wireless connection. It is required to use with a 2.4 GHz wireless connection and a compatible 802.11b/g/n/ac router. The notifications are only as reliable as your Wireless network and are not a substitute for a third party emergency monitoring service.



IMPORTANT: Interconnect units within a single family residence only. Otherwise all households will experience unwanted alarms when you test any unit in the series. Interconnected units will only work if they are wired to compatible units and all requirements are met. This unit is designed to be compatible with most First Alert® and BRK Electronics® Models listed in the User's Manual.



WARNING: Failure to meet any of the above requirements could damage the units and cause them to malfunction, removing your protection. AC and AC/DC alarms can be interconnected. Under AC power, all units will alarm when one senses smoke. When power is interrupted, only the AC/DC units in the series will continue to send and receive signals. AC powered alarms will not operate.

When the Alarm Sounds

What to Do If Your Smoke Alarm Sounds

- If the unit alarms and you are not testing the unit, it is warning you of a potentially dangerous situation that requires your immediate attention. NEVER ignore any alarm. Ignoring the alarm may result in injury or death.
- If the unit alarms get everyone out of the house immediately.

What to Do in Case of a Fire

- Don't panic; stay calm. Follow your family escape plan.
- Get out of the house as quickly as possible. Don't stop to get dressed or collect anything.
- Feel doors with the back of your hand before opening them. If a door is cool, open it slowly. Don't open a hot door. Keep doors and windows closed, unless you must escape through them.
- Cover your nose and mouth with a cloth (preferably damp). Take short, shallow breaths.
- Meet at your planned meeting place outside your home, and do a head count to make sure everybody got out safely. Call the Fire Department as soon as possible from outside. Give your address, then your name.
- Never go back inside a burning building for any reason.
- Contact your Fire Department for ideas on making your home safer.

What to Do if the CO Alarm Sounds

1. Press the Test/Silence button (On App or on unit).
2. Call your emergency services, Fire Department or 911.
3. Immediately move to fresh air—outdoors or by an open door or window. Do a head count to check that all persons are accounted for. Do not re-enter the premises, or move away from the open door or window until the emergency services responder has arrived, the premises have been aired out, and your CO alarm remains in its normal condition.
4. After following steps 1-3, if your CO alarm reactivates within a 24-hour period, repeat steps 1-3 and call a qualified appliance technician to investigate for sources of CO from fuel-burning equipment and appliances, and inspect for proper operation of this equipment. If problems are identified during this inspection have the equipment serviced immediately. Note any combustion equipment not inspected by the technician, and consult the manufacturers' instructions, or contact the manufacturers directly, for more information about CO safety and this equipment. Make sure that motor vehicles are not, and have not, been operating in an attached garage or adjacent to the residence.

NOTE: A qualified appliance technician is defined as "a person, firm, corporation, or company that either in person or through a representative, is engaged in and responsible for the installation, testing, servicing, or replacement of heating, ventilation, air conditioning (HVAC) equipment, combustion appliances and equipment, and/or gas fireplaces or other decorative combustion equipment."

Using the Silence Feature

The Alarm Silence Feature

This feature is intended to temporarily silence the horn while you identify and correct the problem. Do not use the Silence Feature in emergency situations. It will not correct a CO problem or extinguish a fire. The Silence Feature can temporarily quiet an unwanted alarm for several minutes. You can silence this smoke/CO alarm by pressing the Test/Silence button on the side of alarm for at least 3-5 seconds or via the Onelink Home App. After the Test/Silence button is released, the Red LED stops during the silence mode.

Silence the End of Life Signal

This silence feature can temporarily quiet the End of Life warning "chirp" for up to 2 days. You can silence the End of Life warning "chirp" by pressing the Test/Silence button or via the Onelink Home App. The horn will chirp, acknowledging that the End of Life silence feature has been activated. After approximately 2 days, the End of Life "chirp" will resume.



WARNING: Never discharge the unit to quiet an unwanted alarm. Discharging the alarm disables the unit and removes your protection.

When the Smoke Alarm Is Silenced	When the CO Alarm Is Silenced
The smoke alarm will remain silent for up to 15 minutes, then return to normal operation.	The CO alarm will remain silent for up to 4 minutes.
If the smoke has not cleared or continues to increase, the device will go back into alarm.	After 4 minutes, if CO levels remain potentially dangerous, the horn will start sounding again.

Factory Reset

This feature is intended to reset the alarm to the original factory settings. There are two ways to reset the alarm to factory settings.

1. Press the Test/Silence button located on the alarm 3 times.
2. From the Onelink Home App.

Weekly Testing



WARNING: NEVER use an open flame of any kind to test this unit. You might accidentally damage or set fire to the unit or to your home. NEVER use vehicle exhaust! Exhaust may cause permanent damage and voids your warranty.



WARNING: DO NOT stand close to the alarm when the horn is sounding. Exposure at close range may be harmful to your hearing. When testing, step away when horn starts sounding.



CAUTION: It is important to test this unit every week to make sure it is working properly. Using the test button is the recommended way to test this smoke/CO alarm.

You can test this smoke/CO alarm by pressing and holding the Test/Silence button on the side of the alarm until alarm voice says "Testing" (typically 3-5 seconds).

During Testing, You Will See and Hear the Following Sequence:

- "The alarm voice will say "This is only a test. The alarm will sound and for your protection is very loud. The test will start in 5 seconds. 5...4...3...2...1." The LED chases Blue. The alarm voice will say "Testing Smoke." The horn will sound 3 beeps, twice. The LED chases and flashes Red. The alarm voice will say "Evacuate, evacuate, there's fire in the [Location. Example: "Kitchen"]." The LED flashes green."
- "Next, the alarm voice will say "Testing Carbon Monoxide." The horn will sound 4 beeps, twice. The LED chases and flashes Red. The alarm voice will say "Evacuate, evacuate, there's carbon monoxide in the [Location. Example: "Kitchen"]." The LED flashes green. The alarm voice will say "Highest carbon monoxide level was 0 PPM." The LED chases Blue. The alarm voice will then say "The testing is almost complete." After a pause, the alarm voice will say "The test is done, and you are protected." The LED flashes green.

If the unit does not alarm, make sure it has been activated correctly, and test again. If the unit still does not alarm, replace it immediately.

Regular Maintenance

This unit has been designed to be as maintenance-free as possible, but there are a few simple things you must do to keep it working properly:

- Test it at least once a week.
- Clean the smoke/CO alarm at least once a month; gently vacuum the outside of the smoke/CO alarm using your household vacuum's soft brush attachment. A can of clean compressed air (sold at computer or office supply stores) may also be used. Follow manufacturer instructions for use. Test the smoke/CO alarm. Never use water, cleaners or solvents since they may damage the unit.
- After cleaning test the alarm.
- If the smoke/CO alarm becomes contaminated by excessive dirt, dust and/or grime, and cannot be cleaned to avoid unwanted alarms, replace the unit immediately.
- Relocate the unit if it sounds frequent unwanted alarms. See "Where Not To Install" for details.



IMPORTANT: Actual battery service life depends on the smoke/CO alarm and the environment in which it is installed. Regardless of the manufacturer's suggested battery life, you **MUST** replace the alarm immediately once the unit starts "chirping" (the "low battery warning").

Alarm End of Life

Discharging the Alarm

After 10 years of operation or low battery warning, discharge the alarm by following the diagram below: Puncture label in the dotted circle with a screwdriver and slide switch all the way to the left to DISCHARGE.

NOTE: At end of life or low battery indication (chirp): unit must be put into discharge mode to discharge remaining stored energy in battery. Unit will no longer function once put into this mode. Unit will resist re-mounting. Once discharged, replace alarm immediately.

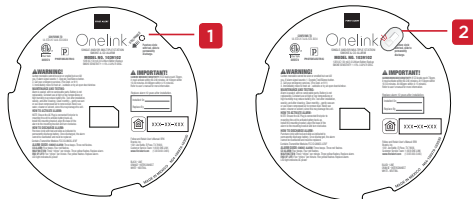

1. Puncture label on dotted circle

2. Slide switch to the left

Ionization & Photoelectric Technology

This alarm uses photoelectric technology.

All First Alert® Onelink® smoke alarms conform to regulatory requirements, including UL217 and are designed to detect particles of combustion. Smoke particles of varying number and size are produced in all fires.

Ionization Technology



Ionization technology is generally more sensitive than photoelectric technology at detecting small particles, which tend to be produced in greater amounts by flaming fires, which consume combustible materials rapidly and spread quickly. Sources of these fires may include paper burning in a wastebasket, or a grease fire in the kitchen.

Photoelectric Technology



Photoelectric technology is generally more sensitive than ionization technology at detecting large particles, which tend to be produced in greater amounts by smoldering fires, which may smolder for hours before bursting into flame. Sources of these fires may include cigarettes burning in couches or bedding.

NOTE: For maximum protection, use both types of smoke alarms on each level and in every bedroom of your home.

Fire Safety Tips

Follow Safety Rules and Prevent Hazardous Situations:

1. Use smoking materials properly. Never smoke in bed.
2. Keep matches or lighters away from children.
3. Store flammable materials in proper containers.
4. Keep electrical appliances in good condition and don't overload electrical circuits.
5. Keep stoves, barbecue grills, fireplaces and chimneys grease-free and debris-free.
6. Never leave anything cooking on the stove unattended.
7. Keep portable heaters and open flames, like candles, away from flammable materials.
8. Don't let rubbish accumulate.

Fire Safety Tips (Continued)

Basic Safety Information

Keep alarms clean, and test them weekly. Replace alarms immediately if they are not working properly. Smoke alarms that do not work cannot alert you to a fire. Keep at least one working fire extinguisher on every floor, and an additional one in the kitchen. Have fire escape ladders or other reliable means of escape from an upper floor in case stairs are blocked.



IMPORTANT: Dangers, Warnings and Cautions alert you to important operating instructions or to potentially hazardous situations. Pay special attention to these items. This smoke/CO alarm is approved for use in single-family residences. It is NOT designed for marine or RV use.



CAUTION: This combination smoke/carbon monoxide alarm has two separate alarms. The CO alarm is not designed to detect fire or any other gas. It will only indicate the presence of carbon monoxide gas at the sensor. Carbon monoxide gas may be present in other areas. The smoke alarm will only indicate the presence of smoke that reaches the sensor. The smoke alarm is not designed to sense gas, heat or flames.



WARNING: This unit will not operate without power. The smoke/CO alarm cannot work until you activate the battery power pack and connect to the power connector. NEVER ignore any alarm. See "What To Do If Your Smoke/CO Alarm Sounds" on page 18 for more information on how to respond to an alarm. Failure to respond can result in injury or death. The Silence Features are for your convenience only and will not correct a problem. See "Using the Silence Feature" on page 19 for details. Always check your home for a potential problem after any alarm. Failure to do so can result in injury or death. Test this smoke/CO alarm once a week. If the alarm ever fails to test correctly, have it replaced immediately! If the alarm is not working properly, it cannot alert you to a problem. This product is intended for use in ordinary indoor locations of family living units. It is not designed to measure CO levels in compliance with Occupational Safety and Health Administration (OSHA) commercial or industrial standards. Individuals with medical conditions that may make them more sensitive to carbon monoxide may consider using warning devices which provide audible and visual signals for carbon monoxide concentrations under 30ppm. For additional information on carbon monoxide and your medical condition, contact your physician.

What You Need to Know About CO

What is CO?

Carbon Monoxide (CO) is an invisible, odorless, tasteless gas produced when fossil fuels do not burn completely, or are exposed to heat (usually fire). Electrical appliances typically do not produce CO.

These Fuels Include: Wood, coal, charcoal, oil, natural gas, gasoline, kerosene, and propane.

Common appliances are often sources of CO. If they are not properly maintained, are improperly ventilated, or malfunction, CO levels can rise quickly. CO is a real danger now that homes are more energy efficient. "Air-tight" homes with added insulation, sealed windows, and other weatherproofing can "trap" CO inside.

Symptoms of CO Poisoning

These symptoms are related to CO POISONING and should be discussed with ALL household members.

Mild Exposure: Slight headache, nausea, vomiting, fatigue ("flu-like" symptoms).

Medium Exposure: Throbbing headache, drowsiness, confusion, fast heart rate.

Extreme Exposure: Convulsions, unconsciousness, heart and lung failure.

Exposure to carbon monoxide can cause brain damage, death.



IMPORTANT: This CO alarm measures exposure to CO over time. It alarms if CO levels are extremely high in a short period of time, or if CO levels reach a certain minimum over a long period of time. The CO alarm generally sounds an alarm before the onset of symptoms in average, healthy adults. Why is this important? Because you need to be warned of a potential CO problem while you can still react in time. In many reported cases of CO exposure, victims may be aware that they are not feeling well, but become disoriented and can no longer react well enough to exit the building or get help. Also, young children and pets may be the first affected. The average healthy adult might not feel any symptoms when the CO alarm sounds. However, people with cardiac or respiratory problems, infants, unborn babies, pregnant mothers, or elderly people can be more quickly and severely affected by CO. If you experience even mild symptoms of CO poisoning, consult your doctor immediately!

Finding the Source of CO After an Alarm

Carbon monoxide is an odorless, invisible gas, which often makes it difficult to locate the source of CO after an alarm. These are a few of the factors that can make it difficult to locate sources of CO:

- House well ventilated before the investigator arrives.
- Problem caused by "backdrafting."
- Transient CO problem caused by special circumstances.

Because CO may dissipate by the time an investigator arrives, it may be difficult to locate the source of CO.

BRK Brands, Inc. shall not be obligated to pay for any carbon monoxide investigation or service call.

Potential Sources of CO in the Home

Fuel-Burning Appliances: Like portable heater, gas or wood burning fireplace, gas kitchen range or cooktop, gas clothes dryer.

Damaged or Insufficient Venting: Corroded or disconnected water heater vent pipe, leaking chimney pipe or flue, or cracked heat exchanger, blocked or clogged chimney opening.

Improper Use of Appliance/Device: Operating a barbecue grill or vehicle in an enclosed area (like a garage or screened porch).

Transient CO Problems: "Transient" or on-again-off-again CO problems can be caused by outdoor conditions and other special circumstances. The following conditions can result in transient CO situations:

1. Excessive spillage or reverse venting of fuel appliances caused by outdoor conditions such as:
 - Wind direction and/or velocity, including high, gusty winds. Heavy air in the vent pipes (cold/humid air with extended periods between cycles).
 - Negative pressure differential resulting from the use of exhaust fans.
 - Several appliances running at the same time competing for limited fresh air.
 - Vent pipe connections vibrating loose from clothes dryers, furnaces, or water heaters.
 - Obstructions in or unconventional vent pipe designs which can amplify the above situations.
2. Extended operation of unvented fuel burning devices (range, oven, fireplace).
3. Temperature inversions, which can trap exhaust close to the ground.
4. Car idling in an open or closed attached garage, or near a home.

These conditions are dangerous because they can trap exhaust in your home. Since these conditions can come and go, they are also hard to recreate during a CO investigation.

Potential Sources of CO in the Home (Continued)

How Can I Protect My Family from CO Poisoning?

A CO alarm is an excellent means of protection. It monitors the air and sounds a loud alarm before carbon monoxide levels become threatening for average, healthy adults.

A CO alarm is not a substitute for proper maintenance of home appliances.

To help prevent CO problems and reduce the risk of CO poisoning:

- Clean chimneys and flues yearly. Keep them free of debris, leaves, and nests for proper air flow. Also, have a professional check for rust and corrosion, cracks, or separations. These conditions can prevent proper air movement and cause back-drafting. Never "cap" or cover a chimney in any way that would block air flow.
- Test and maintain all fuel-burning equipment annually. Many local gas or oil companies and HVAC companies offer appliance inspections for a nominal fee.
- Make regular visual inspections of all fuel-burning appliances. Check appliances for excessive rust and scaling. Also check the flame on the burner and pilot lights. The flame should be blue. A yellow flame means fuel is not being burned completely and CO may be present. Keep the blower door on the furnace closed. Use vents or fans when they are available on all fuel-burning appliances. Make sure appliances are vented to the outside. Do not grill or barbecue indoors, or in garages or onscreen porches.
- Check for exhaust back-flow from CO sources. Check the draft hood on an operating furnace for a back-draft. Look for cracks on furnace heat exchangers.
- Check the house or garage on the other side of shared wall.
- Keep windows and doors open slightly. If you suspect that CO is escaping into your home, open a window or a door. Opening windows and doors can significantly decrease CO levels.

Regulatory Information for CO Alarms

What Levels of CO Cause an Alarm?

Underwriters Laboratories Inc. Standard UL2034 requires residential CO alarms to sound when exposed to levels of CO and exposure times as described below. They are measured in parts per million (ppm) of CO over time (in minutes).

UL2034 Required Alarm Points*:

- If the alarm is exposed to 400 ppm of CO, IT MUST ALARM BETWEEN 4 & 15 MINUTES.
- If the alarm is exposed to 150 ppm of CO, IT MUST ALARM BETWEEN 10 & 50 MINUTES.
- If the alarm is exposed to 70 ppm of CO, IT MUST ALARM BETWEEN 60 & 240 MINUTES.
*Approximately 10% of COHb exposure at levels of 10% to 95% Relative Humidity (RH).

This unit is designed not to alarm when exposed to a constant level of 30 ppm for 30 days.



IMPORTANT: CO alarms are designed to alarm before there is an immediate life threat. Since you cannot see or smell CO, never assume it's not present. An exposure to 100 ppm of CO for 20 minutes may not affect average, healthy adults but after 4 hours the same level may cause headaches. An exposure to 400 ppm of CO may cause headaches in average, healthy adults after 35 minutes, but can cause death after 2 hours.

Standards

Underwriters Laboratories Inc. Single and Multiple Station carbon monoxide alarms UL2034. According to Underwriters Laboratories Inc. UL2034, Section 1-1.2: "Carbon monoxide alarms covered by these requirements are intended to respond to the presence of carbon monoxide from sources such as, but not limited to, exhaust from internal-combustion engines, abnormal operation of fuel-fired appliances, and fireplaces. CO alarms are intended to alarm at carbon monoxide levels below those that could cause a loss of ability to react to the dangers of carbon monoxide exposure." This CO alarm monitors the air at the alarm, and is designed to alarm before CO levels become life threatening. This allows you precious time to leave the house and correct the problem. This is only possible if alarms are located, installed, and maintained as described in this manual.

Gas Detection at Typical Temperature and Humidity Ranges

The CO alarm is not formulated to detect CO levels below 30 ppm typically. Tested for false alarm resistance to Methane (500 ppm), Butane (300 ppm), Heptane (500 ppm), Ethyl Acetate (200 ppm), Isopropyl Alcohol (200 ppm) and Carbon Dioxide (5000 ppm). Values measure gas and vapor concentrations in parts per million.

Audible Alarm

85 dB minimum at 10 feet (3 meters).

Regulatory Information for Smoke Alarms

Installing Smoke Alarms in Single-Family Residences

NOTE: This information is specific to the smoke and carbon monoxide alarm and is not applicable to the home automation capability.

The National Fire Protection Association (NFPA), recommends one smoke alarm on every level and in every bedroom. In new construction, the smoke alarms must be AC powered and interconnected. See "Recommended Placement" for details. For additional coverage, it is recommended that you install a smoke alarm in all rooms, halls, storage areas, finished attics, and basements, where temperatures normally remain between 40° F (4.4° C) and 100° F (37.8° C). Make sure no door or other obstruction could keep smoke from reaching the smoke alarms.

For your information, the National Fire Alarm and Signaling Code, NFPA 72, reads as follows:

Required Detection. Where required by applicable laws, codes, or standards for a specific type of occupancy, approved single- and multiple-station smoke alarms shall be installed as follows:

- In all sleeping rooms and guest rooms.
- Outside of each separate dwelling unit sleeping area, within 21 ft (6.4 m) of any door to a sleeping room, the distance measured along a path of travel.
- On every level of a dwelling unit, including basements.
- On every level of a residential board and care occupancy (small facility), including basements and excluding crawl spaces and unfinished attics.
- In the living area(s) of a guest suite In the living area(s) of a residential board and care occupancy

NOTE: When using cleaning products, make sure accommodation spaces are well ventilated.



IMPORTANT: Specific requirements for smoke alarm installation vary from state to state and from region to region. Check with your local Fire Department for current requirements in your area. It is recommended AC or AC/DC units be interconnected for added protection.

Recommended Placement



Smoke Alarm
One on every level and in every bedroom



Carbon Monoxide
One on every level and in every bedroom



Fire Extinguisher
One on every level, plus kitchen and garage



Regulatory Information

Federal Communications Commission (FCC) Compliance Statement

NOTE: This equipment has been tested and found to comply with the limits for a Class B digital device, pursuant to Part 15 of the FCC Rules. These limits are designed to provide reasonable protection against harmful interference in a residential installation. This equipment generates, uses and can radiate radio frequency energy and, if not installed and used in accordance with the instructions, may cause harmful interference to radio communications. However, there is no guarantee that interference will not occur in a particular installation. If this equipment does cause harmful interference to radio or television reception, which can be determined by turning the equipment off and on, the user is encouraged to try to correct the interference by one or more of the following measures:

- Reorient or relocate the receiving antenna.
- Increase the separation between the equipment and receiver.
- Connect the equipment into an outlet on a circuit different from that to which the receiver is connected.
- Consult the dealer or an experienced radio/TV technician for help.



WARNING: Changes or modifications to this unit not expressly approved by the party responsible for compliance could void the user's authority to operate the equipment.

This device complies with Part 15 of the FCC Rules. Operation is subject to the following two conditions: (1) this device may not cause harmful interference, and (2) this device must accept any interference received, including interference that may cause undesired operation.

RF Exposure Information: This equipment complies with FCC radiation exposure limits set forth for an uncontrolled environment. In order to avoid the possibility of exceeding the FCC radio frequency exposure limits, human proximity to the antenna shall not be less than 20cm during normal operation.

Modular Devices FCC and Compliance Statements

OEM Responsibilities to Comply With FCC Regulations

The A76F Module has been certified for integration into products only by OEM integrators under the following condition:

1. The transmitter module must not be co-located or operating in conjunction with any other antenna or transmitter.

As long as the condition above is met, further transmitter testing will not be required. However, the OEM integrator is still responsible for testing their end-product for any additional compliance requirements required with this module installed (for example, digital device emissions, PC peripheral requirements, etc.).



IMPORTANT: In the event that these conditions cannot be met (for certain configurations or co-location with another transmitter), then the FCC authorizations are no longer considered valid and the FCC ID cannot be used on the final product. In these circumstances, the OEM integrator will be responsible for re-evaluating the end product (including the transmitter) and obtaining a separate FCC authorization.

End Product Labeling

The A76F Module is labeled with its own FCC ID. If the FCC ID is not visible when the module is installed inside another device, then the outside of the device into which the module is installed must also display a label referring to the enclosed module. In that case, the final end product must be labeled in a visible area with the following:

“Contains Transmitter Modules FCC ID: 2ANOG-A76F”

Or

“Contains FCC ID: 2ANOG-A76F”

The OEM of the A76F Module must only use the approved antenna(s) listed above, which have been certified with this module. The OEM integrator has to be aware not to provide information to the end user regarding how to install or remove this RF module or change RF related parameters in the user manual of the end product.

To comply with FCC RF radiation exposure limits for general population, the antenna(s) used for this transmitter must not be co-located or operating in conjunction with any other antenna or transmitter.

Special Compliance Considerations

This smoke alarm is suitable for use in apartments, condominiums, townhouses, hospitals, day care facilities, health care facilities, boarding houses, group homes and dormitories provided a primary fire detection system already exists to meet fire detection requirements in common areas like lobbies, hallways, or porches. Using this smoke alarm in common areas may not provide sufficient warning to all residents or meet local fire protection ordinances/regulations.

This smoke alarm alone is not a suitable substitute for complete fire detection systems in places housing many people—like apartment buildings, condominiums, hotels, motels, dormitories, hospitals, health care facilities, nursing homes, day care facilities, or group homes of any kind. It is not a suitable substitute for complete fire detection systems in warehouses, industrial facilities, commercial buildings, and special-purpose non-residential buildings which require special fire detection and alarm systems. Depending on the building codes in your area, this smoke alarm may be used to provide additional protection in these facilities. In new construction, most building codes require the use of AC or AC/DC powered smoke alarms only. In existing construction, AC, AC/DC, or DC powered smoke alarms can be used as specified by local building codes. Refer to NFPA 72 (National Fire Alarm and Signaling Code) and NFPA 101 (Life Safety Code), local building codes, or consult your Fire Department for detailed fire protection requirements in buildings not defined as “households”.

HUD MAP Program: Certain HUD battery powered smoke alarm applications, especially those that fall under HUD 223(f) MAP (Multi-family Accelerated Processing), may require a 10 Year sealed tamper resistant battery. This alarm does not have a 10 Year sealed battery.



General Limitations for Smoke/CO Alarms

This smoke/CO alarm is intended for residential use. It is not intended for use in industrial applications where Occupational Safety and Health Administration (OSHA) requirements for carbon monoxide alarms must be met. The smoke alarm portion of this device is not intended to alert hearing impaired residents. Special purpose smoke alarms should be installed for hearing impaired residents (CO alarms are not yet available for the hearing impaired).

Smoke/CO Alarms May Not Waken All Individuals. Practice the escape plan at least twice a year, making sure that everyone is involved – from kids to grandparents. Allow children to master fire escape planning and practice before holding a fire drill at night when they are sleeping. If children or others do not readily waken to the sound of the smoke/CO alarm, or if there are infants or family members with mobility limitations, make sure that someone is assigned to assist them in fire drill and in the event of an emergency. It is recommended that you hold a fire drill while family members are sleeping in order to determine their response to the sound of the smoke/CO alarm while sleeping and to determine whether they may need assistance in the event of an emergency.

General Limitations for Smoke/CO Alarms (Continued)

Smoke/CO Alarms Cannot Work Without Power. Battery operated units cannot work if the batteries are missing, disconnected or dead, if the wrong type of batteries are used, or if the batteries are not installed correctly. If the AC power is cut off for any reason (open fuse or circuit breaker, failure along a power line or at a power station, electrical fire that burns the electrical wires, etc.). If you are concerned about the limitations of battery or AC power, install both types of units.

This Smoke/CO Alarm Will Not Sense Smoke or CO that Does Not Reach the Sensors. It will only sense smoke or CO at the sensor. Smoke or CO may be present in other areas. Doors or other obstructions may affect the rate at which CO or smoke reaches the sensors. If bedroom doors are usually closed at night, we recommend you install an alarm device (Combination CO and smoke alarm, or separate CO alarms and smoke alarms) in each bedroom and in the hallway between them.

This Smoke/CO Alarm May Not Sense Smoke or CO on Another Level of the Home. Example: This alarm device, installed on the second floor, may not sense smoke or CO in the basement. For this reason, one alarm device may not give adequate early warning. Recommended minimum protection is one alarm device in every sleeping area, every bedroom, and on every level of your home. Some experts recommend battery powered smoke and CO alarms be used in conjunction with interconnected AC powered smoke alarms. For details, see "About Smoke Alarms" for details.

Smoke/CO Alarms May Not Be Heard. The alarm horn loudness meets or exceeds current UL standards of 85 dB at 10 feet (3 meters). However, if the smoke/CO alarm is installed outside the bedroom, it may not wake up a sound sleeper or one who has recently used drugs or has been drinking alcoholic beverages. This is especially true if the door is closed or only partly open. Even persons who are awake may not hear the alarm horn if the sound is blocked by distance or closed doors. Noise from traffic, stereo, radio, television, air conditioner, or other appliances may also prevent alert persons from hearing the alarm horn. This smoke/CO alarm is not intended for people who are hearing impaired.

The alarm may not have time to alarm before the fire itself causes damage, injury, or death, since smoke from some fires may not reach the unit immediately. Examples of this include persons smoking in bed, children playing with matches, or fires caused by violent explosions resulting from escaping gas.

This Smoke/CO Alarm Is Not a Substitute for Life Insurance. Though this smoke/CO alarm warns against increasing CO levels or the presence of smoke, BRK Brands, Inc. does not warrant or imply in any way that they will protect lives. Homeowners and renters must still insure their lives.

This Smoke/CO Alarm Has a Limited Life. Although this smoke/CO alarm and all of its parts have passed many stringent tests and are designed to be as reliable as possible, any of these parts could fail at any time. Therefore, you must test this device weekly. The unit should be replaced immediately if it is not operating properly.

This Smoke/CO Alarm Is Not Foolproof. Like all other electronic devices, this smoke/CO alarm has limitations. It can only detect smoke or CO that reaches the sensors. It may not give early warning of the source of smoke or CO is in a remote part of the home, away from the alarm device.

Troubleshooting Guide

App FAQ		
If the App...	Problem...	You Should...
Is unable to be downloaded or installed.	You cannot download or install the app.	Contact Customer Service Team
Alarm FAQ		
If the Alarm...	Problem...	You Should...
Light flashes yellow and Horn sounds three "chirps" every minute. Voice: "Detector error. Please see manual or call customer service" every 5 hours.	Malfunction Signal. Device is not working properly and needs to be replaced.	Units under warranty should be returned to manufacturer for replacement. See "Limited Warranty" for details.
Horn sounds 5 "chirps" every minute.	End of Life Signal. Alarm needs to be replaced.	Immediately replace and discharge the alarm.
White LED light turns off.	Alarm is running on battery back-up.	Check all connections or restore power.
Does not connect to your Wireless / Bluetooth or opportunity missed for pairing.	Alarm will not pair or you would like to reset the device to clear all settings.	Press the test button 3 times to reset alarm and try to pair to Wireless and Bluetooth again.
"Chirps" once per minute.	The back-up battery is not activated.	Ensure the alarm is correctly attached to the mounting bracket.
Carbon Monoxide Alarm ONLY:		
CO alarm goes back into alarm 4 minutes after you Silence it.	CO levels indicate a potentially dangerous situation.	If you are feeling symptoms of CO poisoning, evacuate your home and call 911 or the Fire Department. Refer to "What To Do if the CO Alarm Sounds" on page 18 for details.
CO alarm sounds frequently even though no high levels of CO are revealed in an investigation.	The CO alarm may be improperly located. Refer to "Where to Install" on page 7 for details.	Relocate your alarm. If frequent alarms continue, have home rechecked for potential CO problems. You may be experiencing an intermittent CO problem.
Smoke Alarm ONLY:		
Smoke alarm sounds when no smoke is visible.	Unwanted alarm may be caused by non-emergency source like cooking smoke.	Silence alarm on App or using unit button; clean the alarm's cover with a soft, clean cloth. If frequent unwanted alarms continue, relocate your alarm. Alarm may be too close to kitchen, cooking appliance, or steamy bathroom.
NOTE: This alarm contains new Wireless and HomeKit technology that is not wirelessly compatible with previously branded OneLink wireless alarms.		
If you have questions that cannot be answered by reading this manual, contact our Customer Service Team at onelinksupport@firstalert.com or 1 (833) ONE-LINK (1-833-663-5465)		

Limited Warranty

BRK Brands, Inc., ("BRK") the maker of First Alert® brand products warrants that for a period of three years from the date of purchase, this product will be free from defects in material and workmanship. BRK, at its option, will repair or replace this product or any component of the product found to be defective during the warranty period. Replacement will be made with a new or re-manufactured product or component. If the product is no longer available, replacement may be made with a similar product of equal or greater value. This is your exclusive warranty. This warranty is valid for the original retail purchaser from the date of initial retail purchase and is not transferable. Keep the original sales receipt. Proof of purchase is required to obtain warranty performance. BRK dealers, service centers, or retail stores selling BRK products do not have the right to alter, modify or any way change the terms and conditions of this warranty. This warranty does not cover normal wear of parts or damage resulting from any of the following: negligent use or misuse of the product, use on improper voltage or current, use contrary to the operating instructions, disassembly, repair or alteration by anyone other than BRK or an authorized service center. Further, the warranty does not cover Acts of God, such as fire, flood, hurricanes and tornadoes or any batteries that are included with this unit. BRK shall not be liable for any incidental or consequential damages caused by the breach of any express or implied warranty. Except to the extent prohibited by applicable law, any implied warranty of merchantability or fitness for a particular purpose is limited in duration to the duration of the above warranty. Some states, provinces or jurisdictions do not allow the exclusion or limitation of incidental or consequential damages or limitations on how long an implied warranty lasts, so the above limitations or exclusion may not apply to you. This warranty gives you specific legal rights, and you may also have other rights that vary from state to state or province to province.

How to Obtain Warranty Service

Service: If service is required, do not return the product to your retailer. In order to obtain warranty service, contact our Customer Service Team at onelinksupport@firstalert.com or **1 (833) ONE-LINK** (1-833-663-5465). To assist us in serving you, please have the model number and date of purchase available when calling.

For Warranty Service Return To: 1301 Joe Battle, El Paso, TX 79936

Disposal: Waste electrical products should not be disposed of with regular household waste. Please recycle where facilities exist. Check local requirements for disposal of Lithium powered electronic devices. The alarm should be discharged before disposal. See, "Discharging the Alarm". You can also return your alarm to us for disposal. For return address see above. Please include a note confirming the product is being returned for disposal.

Communication distance between alarms may vary from home to home depending on environment, construction materials and size of structure. The quantity of alarm required will depend on these factors. See page 12 for details.

Copyright and Technical Specifications

©2018 BRK Brands, Inc. All rights reserved. Distributed by BRK Brands, Inc., Aurora, Illinois 60504. BRK Brands, Inc. is a subsidiary of Newell Brands Inc. (NYSE:NWL). Printed in USA.

Apple HomeKit

Apple, iPhone, iPad, iPad Air, and iPod touch are trademarks of Apple Inc., registered in the U.S. and other countries. HomeKit is a trademark of Apple Inc. App Store is a service mark of Apple Inc. The Bluetooth® word mark and logos are registered trademarks owned by Bluetooth SIG, Inc. and any use of such marks by BRK Brands, Inc., is under license. Other trademarks and trade names are those of their respective owners. Wi-Fi® is a registered trademark of Wi-Fi Alliance.

Controlling this HomeKit-enabled accessory automatically and away from home requires an Apple TV with tvOS 10.0 or later or an iPad with iOS 10.0 or later set up as a home hub.

To control this HomeKit-enabled accessory, iOS 10.0 or later is recommended.

FIRST ALERT

Onelink[®]



SAFE & SOUND

©2018 BRK Brands, Inc. All rights reserved. • Distributed by BRK Brands, Inc.

BRK Brands, Inc. is a subsidiary of Newell Brands Inc. (NYSE:NWL)

3901 Liberty Street Road, Aurora, IL 60504-8122

Customer Service Team: 1 (833) ONE-LINK (1-833-663-5465) • onelink.firstalert.com

06/18 • Printed in USA • MOB-159406-163529