



Parts in the box

Latch A B	Interior Assembly <i>Traditional</i> M <i>Contemporary</i> M	Exterior Assembly <i>Traditional</i> F <i>Contemporary</i> F
Strike C	Keys E	Fasteners 03809 N P 46780 Q S
Adapter Ring D	Mounting Plate G	SmartKey Tool H
		Fasteners 48654 T 49191 U 64109 V

*"B" is not included. If needed, please contact Kwikset to order a drive-in latch for your lock.

ENGLISH

SMARTCODE 914

TOUCHPAD ELECTRONIC DEADBOLT

Installation and User Guide

Required tools

Ruler Phillips head screwdriver

Additional Tools (depending on application)

Hammer Wood block

Kwikset Technical Support
1-866-863-6584
www.kwikset.com

1 Prepare the door and check dimensions

If drilling a new door, use the supplied template and the complete door drilling instructions available at www.kwikset.com/doorprep.

<p>A Measure to confirm that the hole in the door is either 2-1/8" (54 mm) or 1-1/2" (38 mm).</p>	<p>B Measure to confirm that the backset is either 2-3/8" or 2-3/4" (60 or 70 mm).</p>	<p>C Measure to confirm that the hole in the door edge is 1" (25 mm).</p>	<p>D Measure to confirm that the door is between 1-3/8" and 2" (35 mm and 51 mm) thick.</p>
--	---	--	--

Note: Additional door preparation may be required for doors with 1-1/2" (38 mm) holes. Consult the deadbolt drilling instructions at www.kwikset.com/doorprep.

2 Install the latch and strike

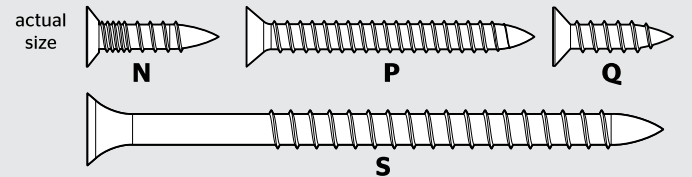

<p>A Is the door edge chiseled?</p> <p>YES chiseled Use latch "A". If the latch bolt is not already extended, extend the latch bolt as shown.</p> <p>NO not chiseled Use latch "B" (not included). If the latch bolt is not already extended, extend the latch bolt as shown.</p>	<p>B Hold the latch in front of the door hole, with the latch face flush against the door edge.</p>	<p>D Which latch are you installing?</p> <p>Latch "A" or Latch "B"</p> <p>N or P (2x)</p> <p>wood block</p>
	<p>C Is the D-shaped hole centered in the door hole?</p> <p>YES D-shaped hole No adjustment is required. Proceed to next step.</p> <p>NO D-shaped hole Rotate latch face as shown to extend latch.</p>	<p>E Install strike on the door frame.</p> <p>⚠ Make sure the hole in the door frame is drilled a minimum of 1" (25 mm) deep.</p> <p>Longer screws install closest to the door jamb. S (2x) Q (2x) door frame</p>

3 Install the exterior keypad

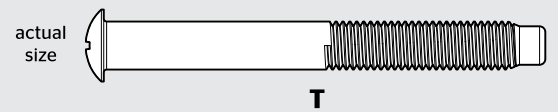

A What is the diameter of the hole in the door?

<p>Diameter is 2-1/8" (54 mm)</p> <p>"D" is required for installation. Install "D" on "F".</p>	<p>or</p>	<p>Diameter is 1-1/2" (38 mm)</p> <p>"D" is not needed for installation. Discard "D".</p>
---	------------------	--

B Locate screws for step 3C and keep them within reach.



C Install exterior keypad and mounting plate.

<p>a</p> <p>Cable goes underneath latch.</p>	<p>b</p> <p>Support exterior assembly during mounting plate installation.</p> <p>Route cable through center hole, then push cable into bottom hole.</p>
<p>c</p> <p>Keep parallel to edge of door.</p> <p>Tighten T (2x) screws evenly.</p>	<p>d</p> <p>Insert key and test latch. If latch does not extend or retract smoothly, adjust screws (T). Remove key when finished and make sure the latch bolt is fully extended.</p>

4 Install the interior assembly

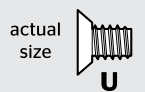

A Remove battery cover and battery pack from interior assembly.

<p>a</p> <p>If the turnpiece is pointing down (as shown above), rotate the turnpiece 180° clockwise until you hear it click. You may need to apply some force.</p>	<p>b</p>
<p>c</p> <p>Incorrect:</p> <p>If the turnpiece is pointing down (as shown above), rotate the turnpiece 180° clockwise until you hear it click. You may need to apply some force.</p>	<p>d</p> <p>Do not install batteries until step 5.</p>

B Install interior assembly onto mounting plate.

<p>a</p> <p>Ensure tight cable connection.</p>	<p>b</p> <p>Lay excess cable flat inside the bottom of the interior housing.</p>
<p>c</p>	<p>d</p> <p>U (2x) bottom hole</p>

5 Set locking and unlocking direction

CAUTION: Your lock will not function properly if this step is not completed. This step will teach your lock the orientation of your door and is crucial to lock operation.

A Install 4 AA batteries in battery pack.

B Make sure the door is open and the latch is extended.

C Press and hold the Lock button. Do not release.

D Insert the battery pack and continue holding the Lock button.

H The latch bolt will retract and extend on its own to learn the locking and unlocking direction of the door.

K

Ensure correct polarity. For best results, use new, non-rechargeable Alkaline batteries only.

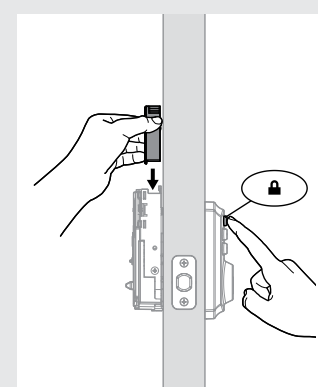
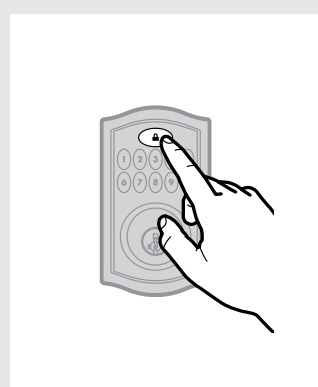
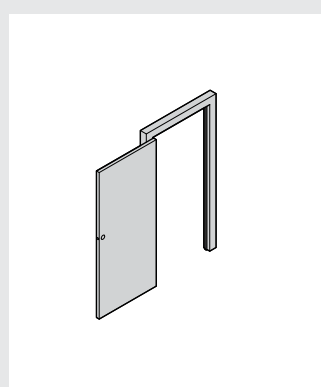

Status LED will indicate success or failure.

Success: LED flashes green
Failure: LED remains solid red

Note: Latch bolt will only retract half way.

If unsuccessful, repeat from step A, moving swiftly between each step.

5 Add the lock to your smart home system

A Initiate the process to add the lock to your system at your smart home controller. Refer to your smart home system instructions for more information.

B When prompted by your smart home system to add the lock, press button "A" on the lock interior one time. The red LED will illuminate when the lock enters Add Mode.

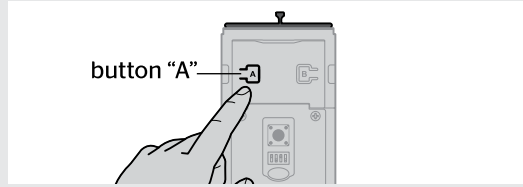

Please allow time for the controller to add the lock.

C If successful, re-name the lock in your system (if applicable).

D If unsuccessful, follow your system's instructions to remove the lock from the controller and any other network, then press button "A" on the lock one time. Perform steps 6A-6C again.

If still unsuccessful, consult the Programming and Troubleshooting Guide on the SmartCode 914 page at www.kwikset.com.

6 Add user codes (30 max)

It is recommended that you add and delete all user codes through your smart home control system. If your system does not allow this, codes may be added directly to the lock as shown here.

Programming Timeout

During programming, if no button is pressed for five seconds, the system will time out (indicated by three beeps and a red flashing keypad), and you will need to restart the procedure.

A Make sure the door is open. Press the Program button once.

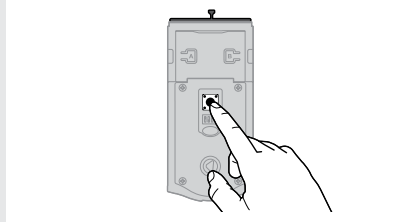

B Enter user code. A total of 30 user codes may be programmed.

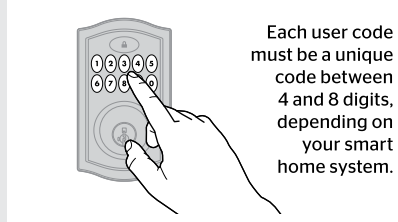

Each user code must be a unique code between 4 and 8 digits, depending on your smart home system.

C Press Lock button once.

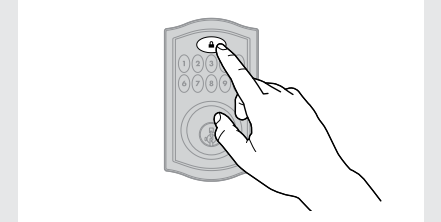

D What lights and sounds does the lock produce?

Mastercode

For enhanced security, a mastercode may be used when adding and deleting user codes. For more information about the mastercode, download the Programming and Troubleshooting Guide on the SmartCode 914 page at kwikset.com.

One green flash with one beep

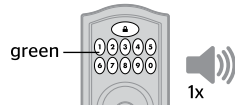

Programming was successful.

or

Three red flashes with three beeps

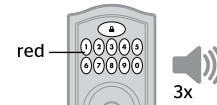

Programming was unsuccessful.

Make sure not to pause for more than 5 seconds during programming. Make sure the user code is not a duplicate and that it is between 4 and 8 digits during your next attempt. Make sure the lock has room for an additional code. If all user code positions are filled, delete a code to make room for this one.

*Beeping sound will only be heard if switch #3 (on the lock interior) is in the on position. See "Switches and Status LED Colors" on page 4.

7 Test the lock (review normal operation)

Confirm that the code(s) added in previous step can unlock the door.

Locking the Door

Press Lock button once.

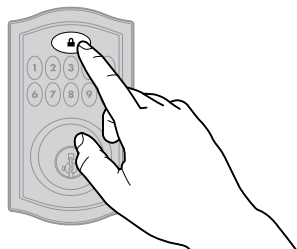

Unlocking the Door

Enter user code.

Tip: You can press the Lock button before entering your user code to light up the keypad at night.

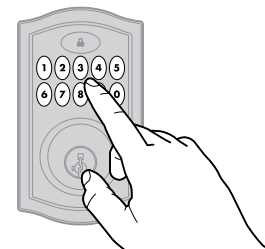

9 Install the interior cover

actual size

Important Information about the interior cover

The window on the interior cover is locked by default to prevent someone from tampering with your lock's settings.

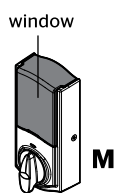

For easy access to the battery pack, unlock the window by removing the security screw.

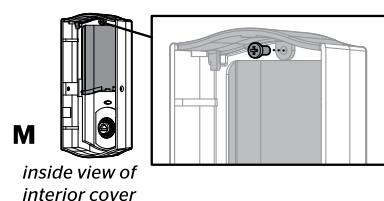

You can now slide up the window for more convenient access to the programming buttons and the battery pack while the cover is installed.

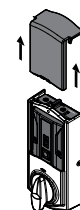

Cover Installation

a Install cover.

Note: You may need to rotate the turnpiece to align with the turnpiece shaft.

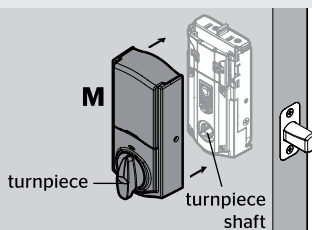

b Install screws.

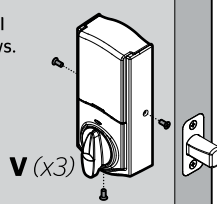

Battery Pack Access

If the window is unlocked, slide up the window to access the battery pack.

If the window is locked, remove the interior cover and screws to access the battery pack.

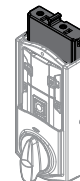

SmartCode at a Glance

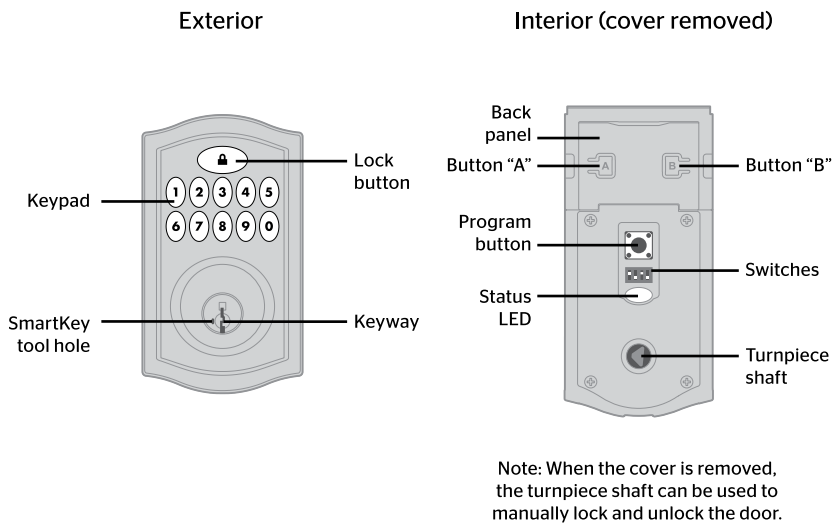

Re-key the lock (if needed)

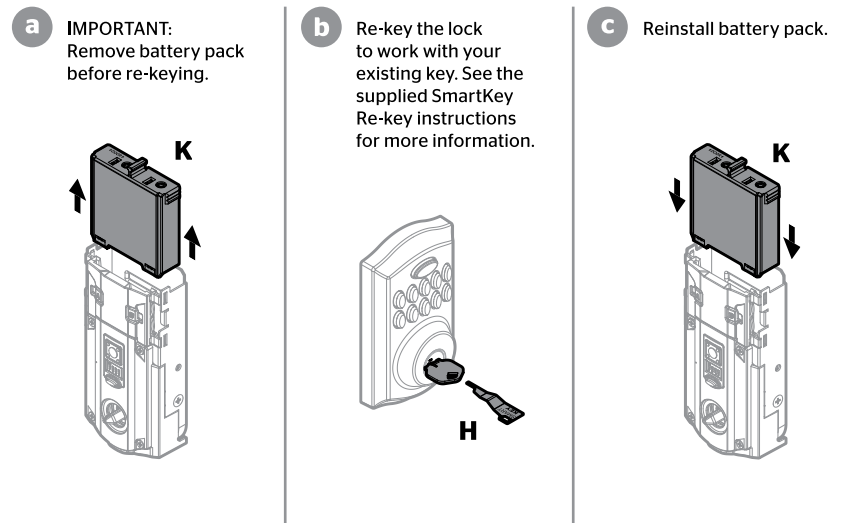

Switches and Status LED colors



Switch	Function
1	Door lock status LED blinks every 6 seconds
2	Lock automatically re-locks door 30 seconds after unlocking. Disabled if no codes are programmed.
3	Audio
4	Not used.

Color	Lock Status
Blinking green	Unlocked
Blinking amber	Locked
Blinking red	Low battery
Solid red	Door handing process did not work properly. See the online Programming and Troubleshooting Guide.

System Alerts

Alert	Reason	Solution
Keypad flashes red once with one beep*.	One incorrect code entered.	Re-enter code.
Keypad flashes red three times with three beeps*.	No user code programmed.	Program at least one user code.
	Programming timeout after five seconds. Unsuccessful programming.	Attempt programming procedure again.
Keypad flashes red 15 times with 15 beeps*	Three consecutive incorrect codes entered.	Re-enter code after 60 second keypad lockout.
Keypad flashes red 10 times with 10 beeps.*	Low battery.	Replace batteries.
Keypad flashes green with continuous beeping sound for two seconds.*	Deadbolt is jammed and stuck in the locked position.	Manually re-lock door. If needed, reposition strike.
Keypad flashes red with continuous beeping sound for two seconds.*	Deadbolt is jammed and stuck in the unlocked position.	Manually re-lock door. If needed, reposition strike.
Lock beeps continuously.*	Interior assembly is disconnected from exterior.	Remove battery pack, reconnect the interior to the exterior, then reinstall battery pack.

*Beeping sound will only be heard if switch #3 is on.

Deleting a single user code

Note: All codes may be deleted at once if the mastercode is enabled. For more information about the mastercode, consult the Programming and Troubleshooting Guide.

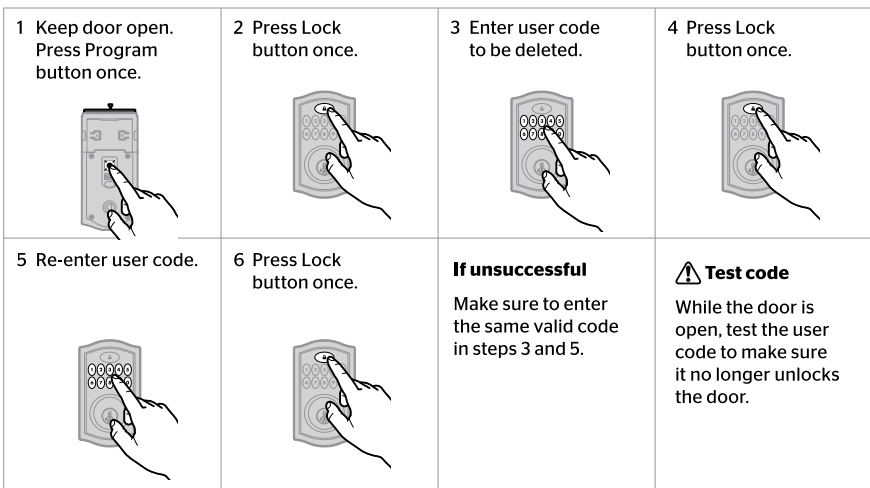

If no button is pressed for five seconds, the system will time out, and you will need to restart the procedure.

Factory Reset

A factory reset will delete all codes associated with the lock, and it will remove it from your smart home system.

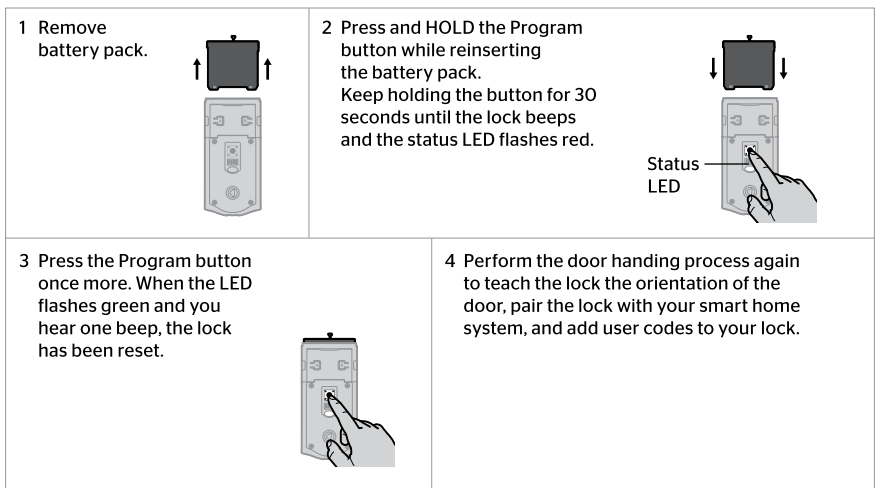

Troubleshooting

A complete Programming and Troubleshooting Guide is available on the SmartCode 914 page at www.kwikset.com.

Network Information

Removing the lock from the network

Follow your smart home system's instructions to remove the lock from the network. When prompted by the system, press button A on the lock interior once.

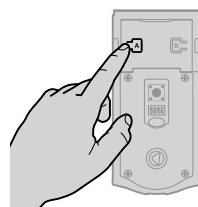

Z-Wave System Notes

This product is a security enabled Z-wave Plus product and must be used with a Security Enabled Z-Wave controller to be fully utilized. Z-Wave is a "Wireless mesh network," and results may vary based on building construction and communication path.

To assure interoperability, each Z-Wave product must pass a stringent conformance test to assure that it meets the Z-Wave standard for complete compliance with all other devices and controls. The Z-Wave identity mark assures consumers, integrators, dealers and manufacturers that their products will reliably perform with any other Z-Wave device. And, regardless of the vendor, always powered nodes may act as a repeater for Kwikset/Weiser/Baldwin products.

Z-Wave Configuration and Association Parameters are available on the SmartCode 914 page at www.kwikset.com.

Important Safeguards

1. Read all instructions in their entirety.
2. Familiarize yourself with all warning and caution statements.
3. Remind all family members of safety precautions.
4. Protect your user codes and mastercode.
5. Dispose of used batteries according to local laws and regulations.

CAUTION: Prevent unauthorized entry. Since anyone with access to the back panel can change the user codes, you must restrict access to the back panel and routinely check the user codes to ensure they have not been altered without your knowledge. The use of a mastercode can help protect your system's settings.

WARNING: This Manufacturer advises that no lock can provide complete security by itself. This lock may be defeated by forcible or technical means, or evaded by entry elsewhere on the property. No lock can substitute for caution, awareness of your environment, and common sense. Builder's hardware is available in multiple performance grades to suit the application. In order to enhance security and reduce risk, you should consult a qualified locksmith or other security professional.