

SPARX

SKATE SHARPENER



OPERATING MANUAL

SAFETY	1
Safety Precautions	1
FCC Notice (for U.S. Customers)	2
Industry Canada Compliance	2
SÉCURITÉ	3
Consignes de sécurité	3
Conformité aux normes d'Industrie Canada	4
INTRODUCTION	5
Technical Specifications	5
Getting to Know Your Sparx Sharpener	6
What's In the Box?	7
Getting to Know the Keypad	8
Grinding Ring Life Indicator Behavior	9
SETUP	10
Lifting Head Unit	10
Assembling the Sharpener	11
Alignment	11
OPERATION	15
Loading a Skate	15
Adjusting the Grinding Ring Height	16
Selecting the Number of Cycles	17
Sharpening a Skate	18
Unloading a Skate	18
Edge Deburring	19
Powering Off	19
Goalie Skates	20
Figure Skates	21
Sharpening New Steel	22
TROUBLESHOOTING	23
Error Types	23
User Interface Prompts	24
Error Codes	25
MAINTENANCE	26
Removing the Head Unit	26
Removing and Emptying the Sharpener Base	27
Replacing the Air Filter	27
Traveling with the Sharpener	29
WARRANTY	30

SAFETY

SAFETY PRECAUTIONS

1. Before operating the Sparx™ Skate Sharpener, you should familiarize yourself with the product and read and understand all applicable instructions and warnings in this manual.
2. Use personal protective equipment. Always wear eye protection and a dust mask while operating the sharpener.
3. For emergencies: press the  **Cancel Button** two times. This will stop the **Grinding Ring** in its place. Do not stop the **Grinding Ring** unless it is an emergency, as this may damage the skate blade.
4. We do not recommend that children under 13 years of age be permitted to use the Sparx™ Skate Sharpener.
5. The Sparx™ Skate Sharpener is not intended for use by persons (including children 13 years and over) with reduced physical, sensory or mental capabilities, or lack of experience and knowledge, unless they have been given supervision or instruction concerning use of the Skate Sharpener by a qualified adult.
6. Children should be supervised to ensure that they do not play with the Sparx™ Skate Sharpener.
7. The Sparx™ Skate Sharpener may only be used for sharpening skates.
8. Only Sparx™ **Grinding Rings** may be used with this machine.
9. Set up the product securely on a stable surface and in a protected location. It must be placed where no one can step on or trip over the **Power Cord** and where the **Power Cord** cannot be damaged.
10. Always use the Sparx™ Skate Sharpener in a dry, well-lit and non-condensing environment. To avoid the risk of electric shock, do not use the Sparx™ Skate Sharpener in wet or damp conditions.
11. To avoid injury, always use caution when operating the Sparx™ Skate Sharpener or when changing the **Grinding Ring**.
12. Do not attempt to touch the **Grinding Ring**, **Carriage**, or **Skate Clamp** while the **Grinding Ring** is moving. Wait for the **Carriage** and **Grinding Ring** to come to a complete stop before attempting any adjustments or **Grinding Ring** replacement.
13. Make sure that the **Thumb Nut** is tightened down onto the **Grinding Ring** before starting any grinding operation
14. Do not leave the Sparx™ Skate Sharpener running unattended.
15. Never disconnect the **Power Cord** by pulling the wire to disconnect it from the socket.
16. Store the Sparx™ Skate Sharpener in a dry place, out of the reach of children.
17. Maintain the sharpener according to the Maintenance section of this manual. Cleaning the **Sharpener Base** and Replacing the **Air Filter**, at specified intervals, are necessary steps for performance and safety.
18. If at any time the product does not operate normally, see the Troubleshooting section of this manual.
19. There are no user-serviceable parts on the sharpener. The sharpener should only be repaired by a professional Sparx™ Hockey technician, using only original spare parts. Unauthorized repairs could lead to hazardous conditions for the user and/or void the warranty.
20. For any further questions about the sharpener, please contact Sparx™ Hockey Support at 1-855-SPARXHQ (1-855-772-7947) or by email at help@sparxhockey.com.



Warning: Please see the manual for operating instructions.



Caution: Pinch point hazard. Keep hands, hair and other body parts clear of the **Skate Clamp** area.

FCC NOTICE (FOR U.S. CUSTOMERS)

This device complies with Part 15 of the FCC Rules:

Operation is subject to the following conditions:

1. This device may not cause harmful interference, and
2. This device must accept any interference received, including interference that may cause undesired operation

Changes and Modifications not expressly approved by Velasa Sports, Inc. can void your authority to operate this equipment under Federal Communications Commissions rules.

INDUSTRY CANADA COMPLIANCE

This device complies with Industry Canada license-exempt RSS standard(s). Operation is subject to the following two conditions: (1) this device may not cause interference, and (2) this device must accept any interference, including interference that may cause undesired operation of the device.

ENVIRONMENTAL PROTECTION

Waste electrical products should not be disposed of with household waste. Please recycle where facilities exist. Check with your Local Authority or retailer for recycling advice.



CONFORMITY WITH DIRECTIVES

This product is CE marked to denote conformity with: Low Voltage Directive 2014/35/EC, EMC Directive 2014/30/EU, RoHS Directive 2015/863, Radio Equipment Directive 2014/53/EU, WEEE Directive 2012/19/EU

1

SÉCURITÉ

CONSIGNES DE SÉCURITÉ

1. Avant d'utiliser l'affûteuse de patins Sparx^{MC}, vous devez vous familiariser avec le produit et lire et comprendre toutes les instructions et mises en garde dans ce manuel.
2. Portez un équipement de protection individuelle. Portez toujours des lunettes de sécurité et un masque anti-poussières lorsque vous utilisez l'affûteuse de patins.
3. En cas d'urgence : appuyez deux fois de suite sur le bouton  Annuler (Cancel). Ceci immobilise immédiatement la meule d'affûtage. N'arrêtez la meule d'affûtage qu'en cas d'urgence, car cela pourrait endommager la lame du patin.
4. Il n'est pas recommandé que les enfants de moins de 13 ans soient autorisés à utiliser l'affûteuse de patins Sparx^{MC}.
5. L'affûteuse de patins Sparx^{MC} ne doit pas être utilisée par des personnes (y compris des enfants de 13 ans et plus) ayant des capacités physiques, sensorielles ou mentales réduites, ou un manque d'expérience et de connaissances, à moins qu'elles soient surveillées ou qu'elles aient reçu une bonne formation sur l'utilisation de l'affûteuse par un adulte compétent.
6. Les enfants doivent être surveillés pour s'assurer qu'ils ne jouent pas avec l'affûteuse de patins Sparx^{MC}.
7. L'affûteuse de patins Sparx^{MC} doit être utilisée exclusivement pour l'affûtage de patins.
8. La machine doit être utilisée exclusivement avec des meules d'affûtage Sparx^{MC}.
9. Pour assurer la sécurité de tout le monde, installez la machine sur une surface stable et dans un endroit protégé. Elle doit être placée dans un endroit où il n'y a aucun risque que quelqu'un puisse marcher ou trébucher sur le cordon d'alimentation ou le cordon d'alimentation puisse être endommagé.
10. Utilisez l'affûteuse de patins Sparx^{MC} toujours dans un environnement sec, bien éclairé, et sans condensation. Pour éviter tout risque de décharge électrique, n'utilisez jamais l'affûteuse de patins Sparx^{MC} dans des conditions humides ou mouillées.
11. Pour éviter les blessures, soyez toujours prudent lors de l'utilisation de l'affûteuse de patins Sparx^{MC}, ou lors du remplacement de la meule d'affûtage.
12. N'essayez pas de toucher la meule d'affûtage, le guide-meule mobile ou la pince de serrage pendant la rotation et le mouvement de la meule. Attendez l'arrêt complet du guide-meule et de la meule d'affûtage avant de tenter un réglage ou le remplacement de la meule.
13. Assurez-vous que l'écrou à ailettes est serré sur la meule d'affûtage avant de commencer l'affûtage.
14. Ne laissez jamais l'affûteuse de patins Sparx^{MC} sans surveillance pendant qu'elle est en marche.
15. Ne débranchez jamais le cordon d'alimentation en tirant sur le cordon.
16. Rangez l'affûteuse de patins Sparx^{MC} dans un endroit sec, hors de la portée des enfants.
17. Entretenez l'affûteur conformément aux instructions de ce manuel. Le nettoyage de la base de l'affûteur et le remplacement du filtre à air à des intervalles spécifiés sont des étapes nécessaires pour la performance et la sécurité.
18. Si, à tout moment, la machine cesse de fonctionner normalement, consultez la section Diagnostic des pannes de ce manuel.
19. L'affûteuse ne comporte aucune pièce réparable par l'utilisateur. Elle ne doit être réparée que par un technicien professionnel Sparx^{MC} Hockey, exclusivement avec des pièces de rechange d'origine. Les réparations non autorisées pourraient créer des conditions dangereuses pour l'utilisateur ou annuler la garantie.
20. Pour toute question au sujet de l'affûteuse, veuillez communiquer avec le service technique de Sparx^{MC} Hockey au (855-772-7947) ou par courriel à help@sparxhockey.com.



Mise en garde : Veuillez consulter les instructions dans le manuel.



Attention : Danger de pincement. Gardez les mains, les cheveux et d'autres parties du corps à l'écart de la zone de la pince de serrage.

AVIS DE LA FCC (POUR LES CLIENTS DES ÉTATS- UNIS)

Cet appareil est conforme à la section 15 de la réglementation de la FCC :

Le fonctionnement est soumis aux conditions suivantes :

1. Cet appareil ne doit pas causer d'interférences nuisibles, et
2. Cet appareil doit accepter toute interférence reçue, y compris des interférences pouvant provoquer un fonctionnement indésirable.

Tous changements et modifications non explicitement approuvés par Velasa Sports, Inc. peuvent annuler votre droit d'utiliser cet équipement conformément aux règles de la Federal Communications Commission.

CONFORMITÉ À INDUSTRIE CANADA

Cet appareil est conforme à la ou aux normes RSS exemptes de licence d'Industrie Canada. Le fonctionnement est soumis aux deux conditions suivantes : (1) cet appareil ne doit pas causer d'interférences et (2) cet appareil doit accepter toutes les interférences, y compris celles pouvant entraîner un fonctionnement indésirable de l'appareil.

PROTECTION ENVIRONNEMENTALE

Les déchets de produits électriques ne doivent pas être jetés avec les ordures ménagères. Veuillez recycler où les installations existent. Renseignez-vous auprès de votre autorité locale ou de votre revendeur pour obtenir des conseils sur le recyclage.



CONFORMITÉ AUX DIRECTIVES

Ce produit est marqué CE pour indiquer la conformité avec : La directive Basse tension 2014/35/CE, la directive CEM 2014/30/EU, la directive RoHS 2015/863, la directive Équipements radio 2014/53/EU, la directive DEEE 2012/19/EU

2

INTRODUCTION

TECHNICAL SPECIFICATIONS**SKATE COMPATIBILITY**

Hockey Skates

Goalie Skates

Figure Skates*

**Requires an additional adapter, which is sold separately.*

DIMENSIONS AND WEIGHT

Width: 26.5 Inches / 673 mm

Height: 5.0 Inches / 127 mm

Depth: 11.9 Inches / 303 mm

Weight: 22.1 Pounds / 10 kg

ELECTRICAL

Line Voltage: 100-240 Volts AC (50-60 Hz single phase)

Maximum Power Consumption: 140 W



For detailed videos on the individual steps of
the sharpening process, head to:

sparxhockey.com/howto

GETTING TO KNOW YOUR SPARX SHARPENER

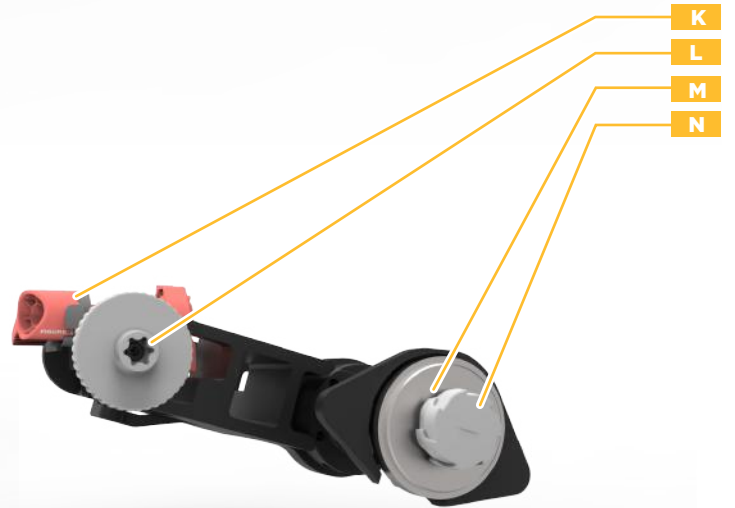
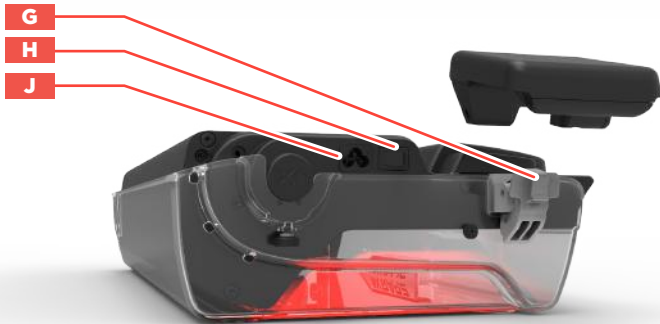

PART	DESCRIPTION
A	Skate Clamp
B	Keypad
C	Clamp Lever
D	Triggers
E	Slot Covers
F	Sharpener Base

PART	DESCRIPTION
G	Lever Dock
H	Power Switch
J	Power Input Port

PART	DESCRIPTION
K	Height Adjustment Knob
L	Alignment Adjustment Driver Slot
M	Grinding Ring Arbor
N	Thumb Nut

WHAT'S IN THE BOX?

1



2



3



4



5



6

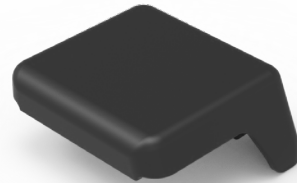

7



PART	DESCRIPTION
1	Travel Guard
2	Power Cord
3	Goalie Risers (2)
4	Optical Alignment Tool
5	Alignment Ring
6	Clamp Lever
7	Alignment Driver

GETTING TO KNOW THE KEYPAD



PART	BUTTON	DESCRIPTION
A	Play	Initiates the sharpening.
B	Grinding Ring Life Indicator	Indicates Grinding Ring life status. See Grinding Ring Life Indicator Behavior table on page 9.
C	Cycle Counter	<ul style="list-style-type: none"> Shows the current number of cycles selected. Shows error codes.
D	Minus Cycles / Move Left	<ul style="list-style-type: none"> Subtracts cycles from the Cycle Counter. If in Move Mode, moves Carriage to the left.
E	Cancel / Error	<ul style="list-style-type: none"> Push 1 time to stop the Carriage at the conclusion of the current pass. Push 2 times for emergency stop, motor stops immediately. When illuminated red, the sharpener is in an error state, see Troubleshooting section of manual.
F	Move	Initiates Move Mode .
G	Alignment	Initiates Alignment Mode .
H	Add Cycles / Move Right	<ul style="list-style-type: none"> Adds cycles from the Cycle Counter. If in Move Mode, moves Carriage to the right.
J	Filter	Indicates replacement needed.

GRINDING RING LIFE INDICATOR BEHAVIOR



In normal operation, each part of the **Grinding Ring Life Indicator** corresponds to 10% of the **Grinding Ring's** life. These parts are the one circle and the nine bars to the right (10 parts total or 100%). The circle represents the final 10% of **Grinding Ring** life and each bar to the right is an additional 10%. When a part is illuminated, that corresponding 10% life is present on the **Grinding Ring**. When the part is no longer illuminated that amount of the wheel life has been consumed.

The circle of the **Grinding Ring Life Indicator** can also behave in other ways to indicate different operating conditions to the user. Refer to the table below for more information.

ICON	ACTION	DESCRIPTION
	Circle is white and steady.	The Grinding Ring has more than 10% of life remaining.
	Circle is white and pulsing.	Grinding Ring has less than 10% of life remaining. We Recommend that the user order a replacement Grinding Ring by visiting www.sparxhockey.com .
	Circle is white and blinking.	User has attempted to start Alignment Mode while a Grinding Ring is installed.
	Circle is red and steady.	No Grinding Ring installed.
	Circle is red and pulsing.	During sharpening, the Grinding Ring has less than 10% of life remaining. We Recommend that the user order a replacement Grinding Ring by visiting www.sparxhockey.com .
	Circle is red and blinking.	Grinding Ring is Empty.
	Circle half red/half white - alternate blinking.	User has attempted to sharpen with a cycle count greater than the number of cycles remaining on the Grinding Ring .

3 SETUP

In order to begin setup of the sharpener, you must retrieve the included accessories that are stored within the Sharpener Base. To gather the accessories and begin setup you must lift the head unit as explained below.

LIFTING HEAD UNIT

▶ To watch the How-To video, visit sparxhockey.com/howto

1 LOCATE THE TRIGGERS

Located on the top of the sharpener head unit are two **Triggers** (A), one on each side of the sharpener.

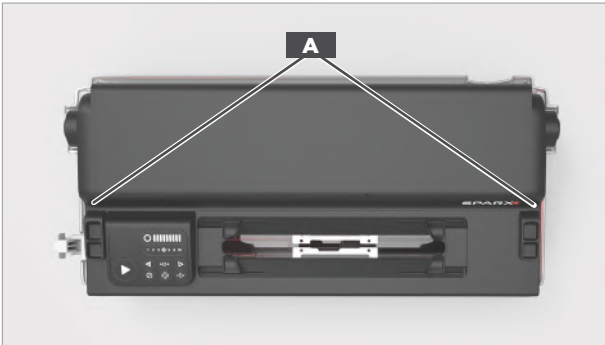

2 SLIDE THE TRIGGERS AND LIFT HEAD UNIT

Slide the triggers down as shown below.



With the triggers slid down, raise the head unit.



3 CLOSE THE HEAD UNIT

Slide the triggers down and place the head unit back into position.

ASSEMBLING THE SHARPENER

▶ To watch the How-To video, visit sparxhockey.com/howto

1 INSTALL THE CLAMP LEVER

Slide the **Clamp Lever** (A) onto the **Lever Dock** (B). Press the lever down until it clicks into place. When the **Clamp Lever** is engaged, it will lay at a slight angle.



2 REMOVE THE TRAVEL GUARD

Open the **Skate Clamp** by pressing and holding down the **Clamp Lever**. Remove the **Travel Guard**. Release the **Clamp Lever**.



Transporting or moving the Sharpener without the **Travel Guard** installed voids your **Warranty** and/or **Extended Service Plan**. Always remove the **Travel Guard** before operating the Sparx Sharpener.

3 PLUG IN THE POWER CORD

Plug the **Power Cord** into the **Power Input Port** on the side of the sharpener. Plug the other end into a wall outlet. Toggle the switch on the **Power Input Port** to the on position (I=on, O=off).

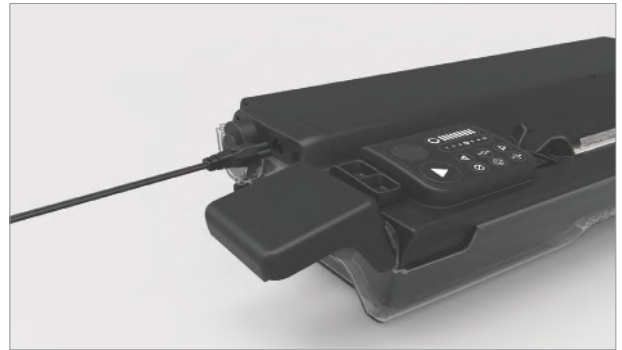

ALIGNMENT

▶ To watch the How-To video, visit sparxhockey.com/howto



The **Alignment** process is required when you first receive your Sparx Sharpener. Be sure to inspect the alignment after every time the sharpener is moved and/or travels.

1 INSTALL THE ALIGNMENT RING

Lift the **Head Unit**. The **Carriage** will automatically move into the install position, and the sharpener will play a “ready” tone. While holding the **Grinding Ring Arbor** (C), unscrew the **Thumb Nut** (A). Slide the **Alignment Ring** (B) onto the **Grinding Ring Arbor** (C), with the label facing out. Replace and tighten the **Thumb Nut** until hand-tight. Close the **Head Unit**.

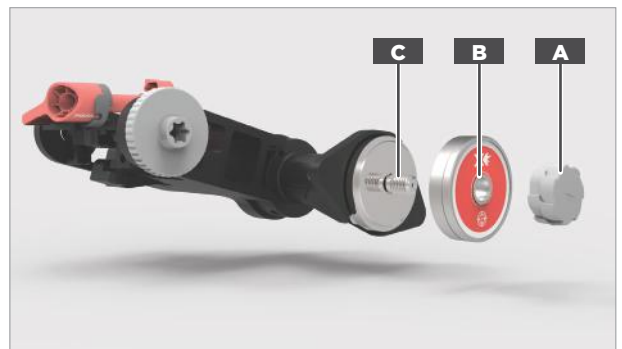

2 INSTALL THE OPTICAL ALIGNMENT TOOL

Press down on the **Clamp Lever** to open the **Skate Clamp**. Place the **Optical Alignment Tool** (with Sparx™ logo facing towards the user) into the **Skate Clamp**. Place the **Optical**

Alignment Tool into the slot and let it fall into place. Release the **Clamp Lever**.



3 INITIATE ALIGNMENT MODE

Press the **Alignment Button** to send the **Carriage** to its alignment position. When the **Carriage** is in place, a tone will sound and the case will illuminate white.

4 LOCATE THE TAB AND GROOVE

Look through the eyepiece of the **Optical Alignment Tool** and locate the indicator tab (A) of the **Optical Alignment Tool** and the groove (B) on the **Alignment Ring**.

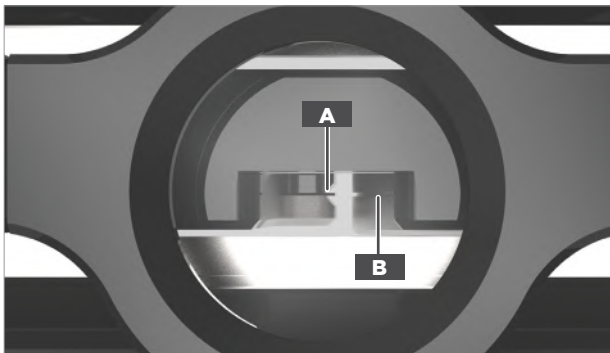

Ensure you are looking straight through the eyepiece directly above the indicator tab and groove. If you see the indicator tab side wall (C) when looking through the eyepiece, you are not directly above the indicator tab and groove. Adjust your line of sight until you can no longer see the indicator tab side wall.

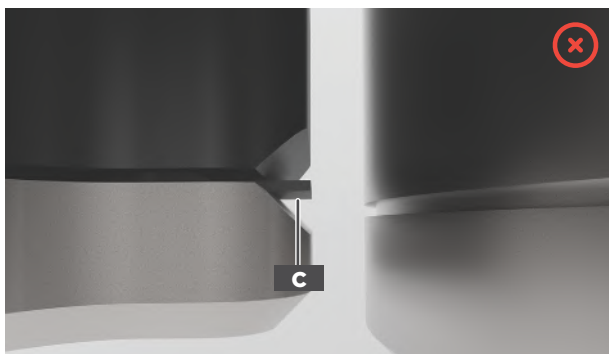

5 INSPECT THE ALIGNMENT

If the indicator tab of the **Alignment Tool** is not aligned with the groove on the **Alignment Ring** (as shown below), move to step 6.

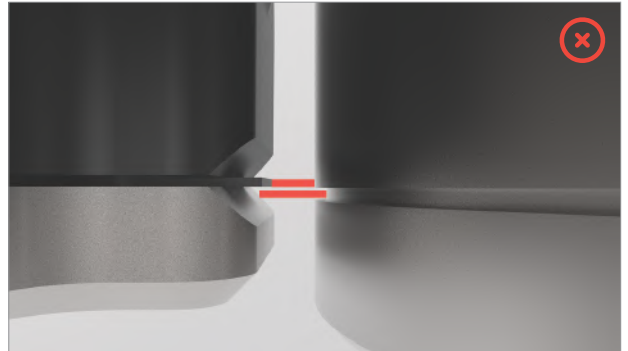

If the indicator tab of the **Alignment Tool** is aligned with the groove on the **Alignment Ring** (as shown below) skip to step 8.

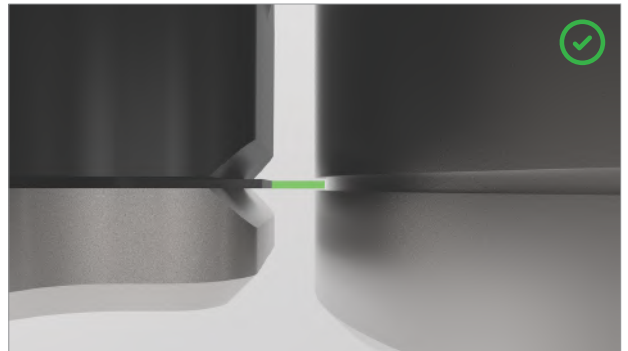

6 ALIGN USING THE ADJUSTMENT DRIVER

Locate the **Driver Slot** and place your **Adjustment Driver** in and begin to adjust your height as needed. Turning to the right moves the adjustment ring closer to you while turning to left moves the ring to the back. Adjust until the indicator tab is aligned with the groove on the **Alignment Ring**. End **Alignment Mode** by pressing the **Alignment Button**.



9 REMOVE THE OPTICAL ALIGNMENT TOOL

Press down on the **Clamp Lever** to open the **Skate Clamp**.
Remove the **Optical Alignment Tool**.

10 REMOVE THE ALIGNMENT RING

Lift the **Head Unit**. The **Carriage** will automatically move into the install position and the sharpener will play a “ready” tone.
While holding the **Grinding Ring Arbor**, unscrew the **Thumb Nut** and remove the **Alignment Ring**.

11 INSTALL THE GRINDING RING

While holding the **Grinding Ring Arbor** (C), slide the **Grinding Ring** (B) on the **Grinding Ring Arbor** (C), label facing out, and replace and tighten the **Thumb Nut** (A) until hand-tight. Close the **Head Unit**.

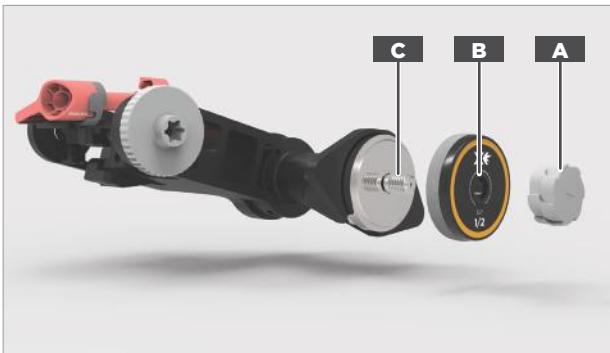

4 OPERATION

LOADING A SKATE

**For loading goalie skates and figure skates see the end of this section.*

▶ To watch the How-To video, visit sparxhockey.com/howto

1 LOAD THE SKATE

Press and hold down the **Clamp Lever** to open the **Skate Clamp**. With the skate toe pointing right and the laces tucked into the skate, set the skate into the **Skate Clamp** slot letting the plastic blade holder rest on top of the clamps. Center the skate blade in the **Skate Clamps**. Release the **Clamp Lever**.



We recommend inserting the skate into the **Skate Clamp** with the toe pointing to the right. For most skate blades, this orientation allows for the greatest flexibility in **Grinding Ring** height adjustment. It is, however, acceptable to insert the skate with the toe facing in either direction.

2 CLOSE THE SLOT COVERS

Move each **Slot Cover (A)** in toward the skate until they touch the blade holder.



ADJUSTING THE GRINDING RING HEIGHT

▶ To watch the How-To video, visit sparxhockey.com/howto



For every pair of skates sharpened, you must assess the height of the **Grinding Ring** and adjust if necessary.

We will first introduce a few new concepts, and then move into the actual adjustment. We want to define an intersection zone, where the vertical face of the blade (B) meets the nearly horizontal face of the blade (C).

This zone can be a curved section of blade (A) like that shown in the figure below or in some cases, it can be a point where surfaces (B) and (C) meet.

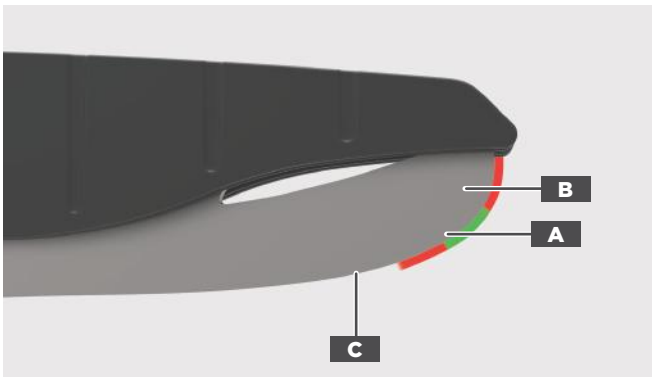

When the intersection zone is a curved surface (A as shown above) the **Grinding Ring** can safely initially contact the blade anywhere in this region (A).

When the intersection zone is a point, which is more common with skates that have been sharpened multiples times, the first contact between the **Grinding Ring** and the blade should be just below the point.

1 INITIATE MOVE MODE

Press the **Move Button** on the **Keypad**. This will set the **Grinding Ring** into **Move Mode** and allow you to control its movement.

2 INSPECT THE CONTACT POINT

Use the **Left** and **Right Buttons** to touch the **Grinding Ring** to the skate blade. Inspect its contact point and be sure it is in the desired position. In the graphic below you will see an example of a contact point that correctly set (A), too high (B), and too low (C). Another way to help visualize the correct contact point would be drawing an imaginary line (green dashed line in the example below) from the center of the **Grinding Ring** to the initial contact point, the line should be at a 45 degree angle. If the **Grinding Ring** is not in a desired position, follow step 3. If the **Grinding Ring** is in a desired position, skip to step 6.

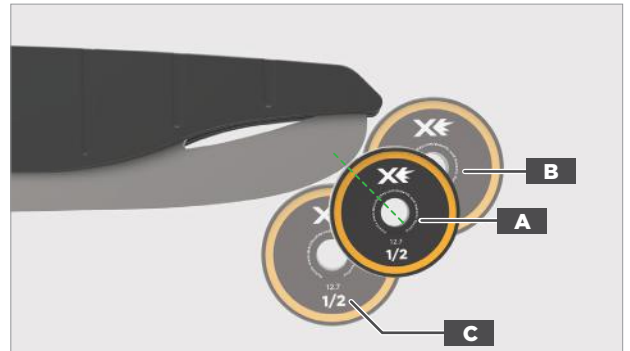

3 MOVE THE CARRIAGE INTO POSITION

Using the **Left** and **Right Buttons** on the **Keypad**, back the **Grinding Ring** off the toe of the skate blade 1/4 inch.

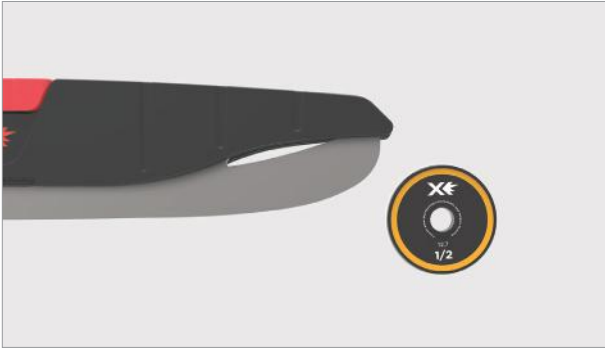

4 ADJUST THE GRINDING RING HEIGHT

Lift the **Head Unit**. Locate the red **Height Adjustment Knob** (A). Turn the knob left to raise the height or right to lower the height until the **Grinding Ring** is at the desired height. The knob is labeled 1-8, with 8 being the highest setting for the **Grinding Ring** and 1 being the lowest setting.



5 INSPECT THE CONTACT POINT

Using the **Left** and **Right Buttons**, touch the **Grinding Ring** to the skate blade. Inspect its contact point and be sure it is in its desired position. Repeat steps 4 and 5 until the **Grinding Ring** makes contact at the desired position.

6 END MOVE MODE

Press the **Move Button** again to send the **Grinding Ring** back to its home position.

SELECTING THE NUMBER OF CYCLES

When the sharpener moves the **Grinding Ring** out and back over the skate blade once, it is called a cycle.

The Sparx™ Sharpener comes set automatically to a standard **4** four cycles with all standard **Radius Ring™** and **FIRE Ring™ Grinding Rings**. We recommend trying four cycles to start and moving higher or lower as needed. Typically, we have found that four cycles will handle normal wear and tear (and even small nicks) from one to four hours of skating between sharpenings. For brand-new steel or when changing **Grinding Ring** hollow depths, we recommend using the **10** 10-cycle setting to ensure you completely reset the skating surface of the blade. See **Sharpening New Steel** at the end of the **Operation** section.

1 ADJUST THE CYCLE COUNT

Use the **Left** and **Right Buttons** (A) on the **Keypad** to adjust the number of cycles desired. The number of cycles selected will be illuminated on the **Cycle Counter** (B).



SHARPENING SKATES

Once you have loaded the skate, closed the **Slot Covers**, and adjusted the height of the **Grinding Ring**, you are ready to begin sharpening.

To cancel the cycles at any point during the sharpening, press the **Cancel Button** once. This will send the **Carriage** back to its home position at the end of its current pass.

1 BEGIN SHARPENING

Press the **Play Button**. Once the button has been pressed, it will change from white to blue and the sharpening process will begin.

Upon pressing the **Play Button**, the **Air Filter** fan and grinding motor will turn on. The **Cycle Counter** will flash with the current cycle number until that cycle (out and in) is completed. The sharpener will continue to run until all cycles have been performed.

At the completion of the final cycle, the end of sharpening is marked by a “cycle complete” tone and the case LEDs will turn green. The fan will continue to run for an additional 30 seconds after the final cycle completes.

ADDITIONAL CYCLES

If additional cycles are desired, you can reset the cycle count and press the **Play Button** again.



If the **Grinding Ring** skips when it first makes contact with the blade, the **Grinding Ring's** height is too high. When properly set, the **Grinding Ring** should make a smooth transition onto the skate blade.

UNLOADING A SKATE

1 DISENGAGE SLOT COVERS

Move both **Slot Covers** (A) away from the skate.



2 REMOVE THE SKATE

Press and hold down the **Clamp Lever** to open the **Skate Clamp**. Remove the skate from the **Skate Clamp** and release the **Clamp Lever**.



EDGE DEBURRING

▶ To watch the How-To video, visit sparxhockey.com/howto



We recommend using protective gloves when deburring the skate blade.

1 DEBURR THE BLADE WITH THE STONE

Press the **Honing Stone** (A) against the face of the skate blade (B). Do not put pressure on the side of the stone closest to the blade edge. With light pressure, press down on the lower side of the stone (C) and slowly run the stone back and forth along the length of the blade for four full passes.

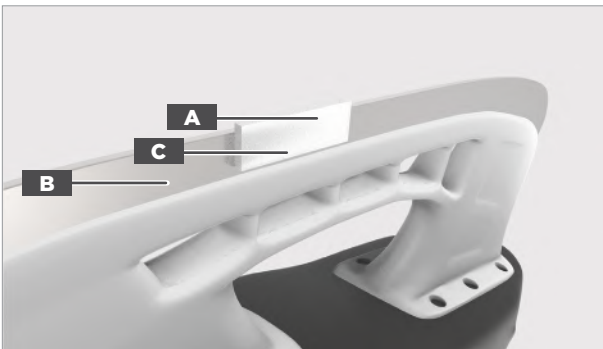

2 REPEAT ON THE OPPOSITE SIDE

Turn the skate over. Repeat step 1 on the opposite side of the blade.

3 DEBURR THE BLADE WITH THE STROP

Press the **Leather Strop** (A) against the edge of the skate blade (B) at a 45 degree angle. With light pressure, slowly run the strop back and forth along the length of the edge for four full passes

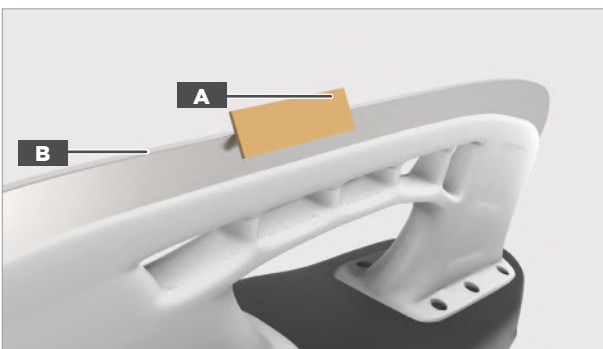

4 REPEAT ON THE OPPOSITE SIDE

Turn the skate over. Repeat step 3 on the opposite edge of the blade.



When deburring coated steel, make sure to only use the **Leather Strop** or the **Coated Steel Kit** (sold separately) to ensure you do not remove or damage the coating.

POWERING OFF

1 LOCATE THE POWER INPUT PORT

On the side of the sharpener, locate the **Power Input Port**.

2 TURN OFF THE SHARPENER

Toggle the **Power Input Port** switch to the off position (I=on, O=off).

GOALIE SKATES

▶ To watch the How-To video, visit sparxhockey.com/howto

Goalie risers are necessary if your skate has a cowling. Goalie skates without a cowling you may sharpen normally without risers.

If your skate does have a cowling, follow the steps below.

1 INSTALL THE GOALIE RISERS

Align the **Anchor Pins (A)** of the **Goalie Risers** to the **Anchor Slots** of the **Skate Clamp**. Once aligned, press down firmly until you feel the **Goalie Risers** snap into place.

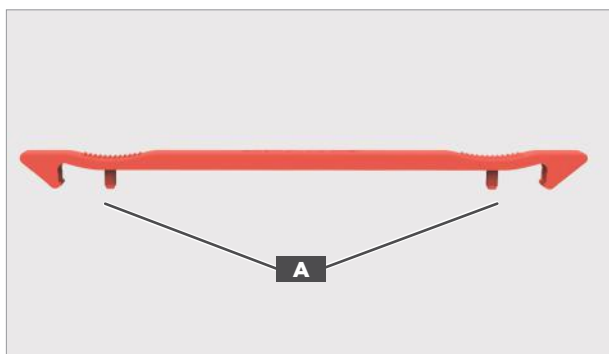

2 CONTINUE THE SHARPENING PROCESS

Refer to “Loading a Skate” in the Operation section of the manual. When adjusting the **Grinding Ring Height**, refer the graphic in step 3.

3 ADJUST THE GRINDING RING HEIGHT

Refer to “Adjusting the Grinding Ring Height” in the Operation section of the manual using the figure below as your guide where the desired contact point is A, contact point B is too high and contact point C is too low.

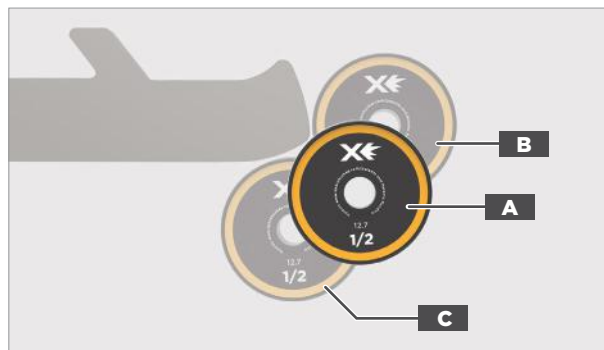

5 CONTINUE THE SHARPENING PROCESS

Refer to “Sharpening Skates” in the Operation section of the manual.

6 REMOVE THE GOALIE RISERS

Pull up on each end of the **Goalie Risers** to remove from the **Skate Clamp**.



FIGURE SKATES

▶ To watch the How-To video, visit sparxhockey.com/howto

** Figure Skate Adapters are sold separately.*

Before loading a figure skate, **Figure Skate Adapters** must be installed onto each end of the skate steel as shown below.

1 PLACE ADAPTER OVER TAIL AND TOE PICK

Using the included wrench tighten the set screw until finger tight do not over tighten, the adapter should still be able to pivot.

Be sure to keep the drag pick covered. After both adapters are installed perform a visual to check to ensure that both adapters are on a level horizontal plane.



2 ADJUST THE GRINDING RING HEIGHT

Set the grinding ring height setting to **Figure (1)**. Look for the contact point at which the grinding ring starts to roll on the skate using the move button. If the contact point is leaving some of the skate blade untouched you may need to adjust the adapter slightly higher.

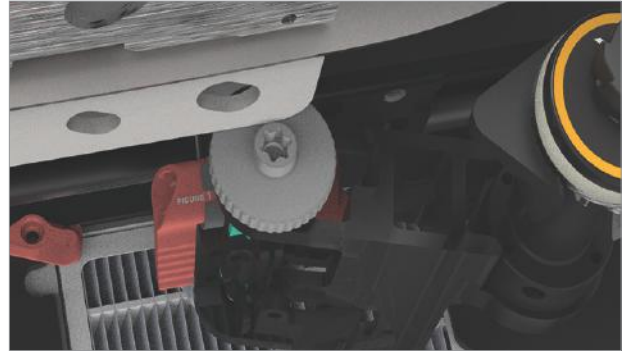

3 INSERT SKATE INTO SKATE CLAMP

We recommend having the toe pointing right. Ensure that the adapters are sitting flush with the top surface of the sharpener.



4 CONTINUE THE SHARPENING PROCESS

Refer to "Sharpening Skates" in the Operation section of the manual.

SHARPENING NEW STEEL

▶ To watch the How-To video, visit sparxhockey.com/howto



Before loading new steel, take a dark colored marker and fill in three strips (1 inch in length the full width of the blade) on the toe, heel, and middle of the bottom surface of the skate blade. To ensure you have sharpened the entire blade, inspect the blade after running the cycles and if the sharpening is complete, all of the marker on the skating surface will be removed.

1 LOAD THE SKATE

After applying the marker (A in the below example), follow the instructions in “Loading a Skate” in the Operation section of this manual.

2 ADJUST GRINDING RING HEIGHT

Follow the instructions in “Adjust the Grinding Ring Height” in the Operation section of this manual.

3 SELECT 10 CYCLES

Using the ◀ Left and ▶ Right Buttons, select 10 on the Cycle Counter.

4 CONTINUE THE SHARPENING PROCESS

Refer to the Operation section of the manual.

5 INSPECT BLADE SURFACE

If the marker is gone (C in the example below), you have successfully set your edges. If there is still marker left on the blade (B), continue running cycles until it is completely gone. Due to variations in blade thickness, steel quality, and edge height difference, some new steel may require fewer than 10 cycles, and some more.

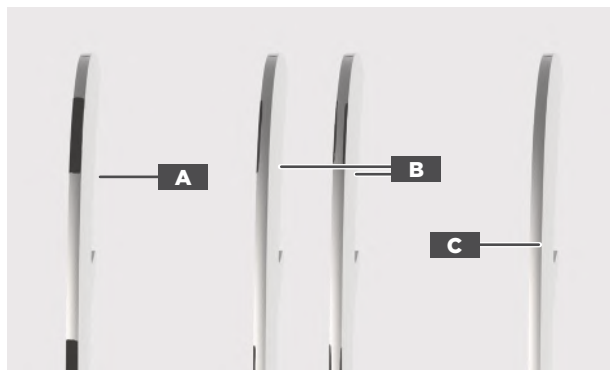

TROUBLESHOOTING

ERROR TYPES

There are two types of errors encountered by the Sparx Skate Sharpener that can interrupt operation. These types are: Function Entry errors and System Stop errors. Each error type is described in the table below along with information about how the user is informed of the error.

ERROR TYPE	DESCRIPTION	DISPLAY METHOD
I: Function Entry	Errors that prevent the user from entering into a function (e.g. sharpening or alignment).	<ul style="list-style-type: none"> • Displayed through the user interface. • Temporarily displayed on the Cycle Counter. • Not saved to Error History.
II: System Stop	Errors that cause the sharpener to exit out of a function because of safety concerns or to prevent sharpener damage.	<ul style="list-style-type: none"> • Displayed on the Cycle Counter. • All functionality is disabled until the user acknowledges the error by pressing the ⊘ Cancel Button. • Saved to Error History.

USER INTERFACE PROMPTS

If you are attempting to sharpen a skate, go into **Alignment Mode**, or go into **Move Mode**, but the sharpener is not allowing it, the sharpener will temporarily display an interface prompt, show an error code, and sound an “error” tone.

The most common Interface prompts are listed in the table for interface prompts below. If the user interface prompt is unclear or only an error code is displaying, refer to the Error Code table on the next page.

ACTION	CAUSE	CORRECTIVE ACTION
<p> Air Filter Button is illuminated red.</p>	<p>Air Filter is either not installed or requires attention.</p>	<ul style="list-style-type: none"> • Install Air Filter. • Press and hold button for two seconds until two beeps sound to reset the Air Filter's life.
<p>Grinding Ring Life Indicator circle is blinking red/white.</p>	<p>Grinding Ring has insufficient life remaining for selected sharpening operation.</p>	<p>Sharpener will reset Cycle Count to maximum available cycles, run sharpener with the new value or lower.</p>
<p>Grinding Ring Life Indicator circle is blinking red.</p>	<p>Grinding Ring not found. / Grinding Ring empty.</p>	<p>Install a valid Grinding Ring.</p>

In the event that an error cannot be resolved, please contact customer support at Sparx Hockey.

SPARX HOCKEY CUSTOMER SUPPORT

help@sparxhockey.com

ERROR CODES

1 2 3 4 5 6 10

For all errors, an error code is displayed on the **Cycle Counter** (1-2-4 is being displayed in the figure above), these error codes will either be permanently or temporarily displayed. If an error code was temporarily displayed and you want to see it again, retrying the action without fixing the underlying cause will display the error. Permanent error codes require the user to acknowledge the error before the error will be resolved and operation can continue. Permanent Error Codes will also be stored in the Error History (discussed below). The troubleshooting table below suggests corrective actions to resolve the error.

If the user wishes to cycle through previous permanent Error Codes, hold down the **Cancel Button** for 2 seconds until a tone is heard (button initially emits an “error” tone when pressed). Once the beep is heard, the most recent Error Code is displayed. Pressing the **Left** and **Right Buttons** will cycle through previous Error Codes.

ERROR CODE	CAUSE	CORRECTIVE ACTION
1 - 2 - 10	Air Filter missing.	Install Air Filter.
1 - 3 - 10	Attempted to start Alignment Mode with skate or Grinding Ring installed.	Remove skate and install Alignment Ring .
1 - 4 - 5	Pressed the Play Button in Alignment Mode .	Exit Alignment Mode by pressing the Alignment Button or Cancel Button prior to pressing the Play button.
1 - 4 - 6	Pressed the Play Button in Move Mode .	Exit Move Mode by pressing the Move Button or Cancel Button prior to pressing the Play button.
2 - 3 - 6	Sharpener failed to detect skate.	Ensure that skate is installed in the Skate Clamp correctly and the Grinding Ring height is adjusted properly.
2 - 4 - 6	Grinding Ring has insufficient life remaining for selected sharpening operation.	Sharpener will reset Cycle Count to maximum available cycles. Run sharpener with the new value or lower.
2 - 4 - 10	Grinding Ring empty.	Install a valid Grinding Ring .
2 - 5 - 6	Grinding Ring not found.	Install a valid Grinding Ring .
2 - 5 - 10	Grinding Ring read incomplete.	Repeat process and allow extra time between steps. If this does not resolve the problem, replace the Grinding Ring .
2 - 6 - 10	Grinding Ring read error.	Install a valid Grinding Ring .
3 - 5 - 10	Grinding motor overcurrent.	Confirm that the Grinding Ring height is adjusted properly and nothing is obstructing the Grinding Ring .
3 - 4 - 10	Hardware Fault Circuitry failure.	Call Customer Support at 1-855-SPARX HQ (1-800-772-7947).
3 - 6 - 10	Translation Error - Limit undetected.	Confirm that the Carriage is not obstructed.
4 - 5 - 10	File System Incompatibility	The installed Grinding Ring is not compatible with the skate sharpener. Install a valid Grinding Ring.

6

MAINTENANCE

REMOVING THE HEAD UNIT

📺 To watch the How-To video, visit sparxhockey.com/howto

1 LIFT THE HEAD UNIT

Slide the **Triggers** down and lift **Head Unit** to the furthest open position.



2 REMOVE HEAD UNIT THUMB SCREWS

Locate the two thumb screws (A), one located on each side of the sharpener. Unscrew the thumb screws and lift the **Head Unit** straight up.

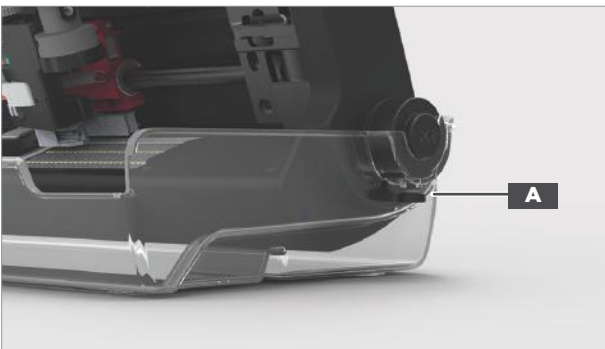

3 SEPARATE HEAD UNIT FROM THE SHARPENER BASE

Firmly grasp the **Head Unit** with two hands and lift it out of the **Sharpener Base**. Gently place the **Head Unit** down onto a clear surface.

4 REPLACE HEAD UNIT

Place the **Head Unit** back onto the **Sharpener Base**, maintaining the same angled position the **Head Unit** was in when it was removed. Screw the two thumb screws back into the hinges.





There are no user-repairable parts in the Sparx Skate Sharpener. Refer to “Exclusions” in the Warranty section for more information. Maintenance of the Sparx Skate Sharpener is limited to the procedures outlined in this section.

REMOVING AND EMPTYING THE SHARPENER BASE

To watch the How-To video, visit sparxhockey.com/howto

Maintenance Frequency: Perform the following steps after every ½ Grinding Ring of sharpener use (160 cycles on the Radius Ring™ and the FIRE Ring™) and before moving and/or traveling with the sharpener.

1 REMOVE AND EMPTY THE SHARPENER BASE

Remove the **Head Unit** from the top of the **Sharpener Base**. To empty **Sharpener Base**—wipe completely clean with a damp cloth (water).

! Do not use any solvents or cleaning chemicals in and around the **Skate Sharpener**.



2 VACUUM SHARPENER

Without removing the **Air Filter**, thoroughly vacuum the top, sides, and around the **Air Filter Housing**. We recommend using a HEPA certified vacuum.

3 CLOSE THE HEAD UNIT

Install the **Head Unit** back onto the top of the Sharpener.

REPLACING THE AIR FILTER

To order a replacement **Air Filter**, visit sparxhockey.com/filter.

To watch the How-To video, visit sparxhockey.com/howto

Standard Grinding Ring Use (Radius Rings™ and FIRE Rings™): The **Air Filter** should be replaced every 4 **Grinding Rings** (1,280 cycles).

Maintenance Frequency: The **Air Filter** replacement limits listed above are related to the type of **Grinding Rings** being used and refer to the maximum amount of usage that an **Air Filter** should have when using a specific type of **Grinding Ring**.

The **Air Filter Button** will light up to remind you to replace the **Air Filter** at the **Standard Grinding Ring Use** interval ONLY

1 ENTER FILTER REPLACEMENT MODE

Power the sharpener on and click the **Air Filter Button**. The carriage will reposition itself away from the **Air Filter**.

2 OPEN HEAD UNIT AND CLEAN BASE

Open the **Head Unit**. To empty **Sharpener Base**—wipe completely clean with a damp cloth (water).

! Do not use any solvents or cleaning chemicals in and around the **Skate Sharpener**.

3 VACUUM SHARPENER

Before removing the **Air Filter**, thoroughly vacuum the top, sides, and around the **Air Filter Housing**. We recommend using a HEPA certified vacuum.

4 REMOVE THE OLD FILTER

Pivot the **Filter Clamps (A)** so that they are no longer holding the **Air Filter** in place.

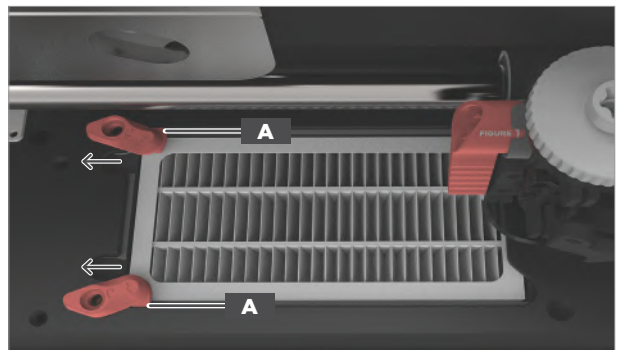



Pull up on the **Air Filter Pull-Tab** to lift the filter out of the sharpener.

5 INSERT THE NEW AIR FILTER

Vacuum any remaining dust from the **Filter Housing** area.

Insert the new **Air Filter** with the pull-tab on the left-hand side and black seal going into the sharpener. Once inserted, pivot the **Filter Clamps** into their original positions.

6 RESET THE AIR FILTER BUTTON

Once your filter has been replaced, hold down the  **Air Filter Button** for two seconds until an audible tone is heard to reset the system and extinguish the  **Air Filter Button**.

TRAVELING WITH THE SHARPENER

▶ To watch the How-To video, visit sparxhockey.com/howto

1 EMPTY THE SHARPENER BASE

Lift the **Head Unit** and wipe the **Sharpener Base**. To empty **Sharpener Base**—wipe completely clean with a damp cloth (water).

! Do not use any solvents or cleaning chemicals in and around the **Skate Sharpener**.



2 VACUUM SHARPENER

Without removing the **Air Filter**, vacuum the top of and around the **Air Filter Housing**. We recommend using a HEPA certified vacuum.

3 INSTALL THE TRAVEL GUARD

Open the **Skate Clamp** by pressing and holding down the **Clamp Lever**. Install the **Travel Guard** by placing the claw of the **Travel Guard** behind the **Grinding Ring Arbor's** impeller as shown below. Release the **Clamp Lever**. Ensure that the middle section of the **Travel Guard** is held securely in the **Skate Clamp**.



4 REMOVE THE CLAMP LEVER

Slide the **Clamp Lever (A)** off of the **Lever Dock**.



5 TRAVEL WITH THE SPARX TRAVEL CASE

For the highest level of protection and safety when traveling with your Sparx Skate Sharpener and accessories, we recommend using the Sparx Travel Case (sold separately).



When setting up the Sparx Sharpener after travel, wipe down the **Grinding Ring Arbor's** face and threaded arbor to remove any unwanted steel shavings that may have gathered during transit. This will ensure a proper fit between the **Grinding Ring Arbor** and the **Grinding Ring**.

7

WARRANTY

ANY PURCHASE OF A SPARX HOCKEY PRODUCT IS COVERED UNDER THE ASSOCIATED PRODUCT WARRANTY POSTED AT

[SPARXHOCKEY.COM/WARRANTIES](https://www.sparxhockey.com/warranties)

AT THE TIME OF THE SALE OF THE SPARX HOCKEY PRODUCT

VELASA SPORTS MAY AT ANY TIME AND IN IT'S SOLE DISCRETION, MODIFY ANY OF THE TERMS AND CONDITIONS CONTAINED IN THE WARRANTY POLICY.

VELASA SPORTS, INC. 30 SUDBURY RD. ACTON, MA 01720 USA
COPYRIGHT © 2018 VELASA SPORTS INC.
ALL RIGHTS RESERVED
11632 REVISION B - 07.30.2020