

R17D SOCKET LED LINEAR TUBE

8FT 40W

DESCRIPTION

- Two ended bypass
- Environmentally friendly without mercury
- 50,000 hours or more working time and 5 year warranty
- No mercury

WARRANTY

This product has a warranty for a period of 3 years from the date of purchase. The warranty is invalid in the case of improper installation, tampering, or removal of the Q.C. date label. Installation in an improper working environment or installation not according to the current edition of the National Electric Code also invalidates the warranty. Should this product fail during the warranty period, it will be replaced free of charge, subject to correct installation and return of the faulty unit. Greentek Energy Systems does not accept responsibility for any installation costs associated with the replacement of this product. This warranty is in addition to the statutory rights in the country of purchase. Greentek Energy Systems reserves the right to alter specifications without prior notice.

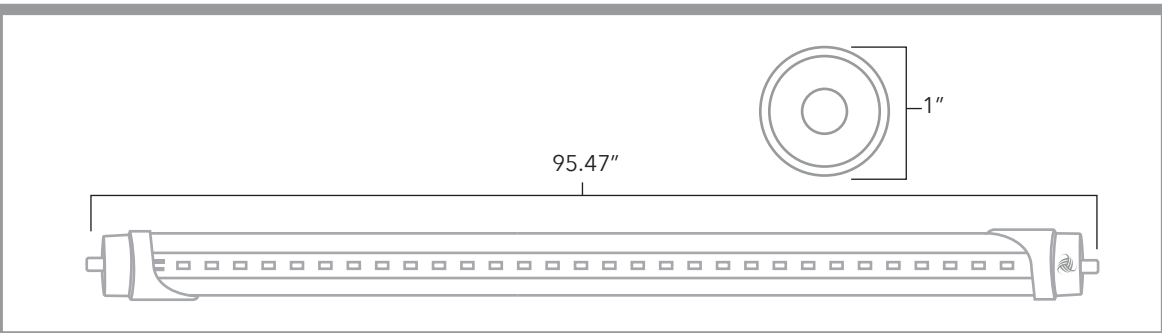
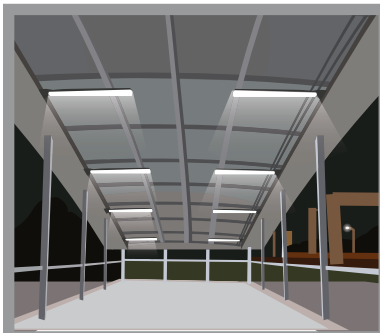

SKU	8FT:GT-T88F40W-R17D 5000K C	Certification	ETL	Lumens	4400
	8FT:GT-T88F40W-R17D 5000K F	Box Dimension	95.47" x 8.27" x 7.28"	Color	5000K, 6000K
	8FT:GT-T88F40W-R17D 6000K C	Watts	40W	Trim	Clear, Frosted
	8FT:GT-T88F40W-R17D 6000K F	Lumens efficiency	120 lm/w	CRI	> 80

R17D SOCKET LED LINEAR TUBE

8FT 40W

Input Voltage	100-277V	Warranty	3 years
Operation Temperature	-68~122 °F	Power factor	0.95
Lifespan	50,000 hours	LED type	SMD2835
Base	R17D	Wiring	Two ended bypass
Package Count	20	Housing material	Aluminum + PC
Tube Dimension	7.9' x 1"		

WARNING

- Not for use in vapor-tight fixture
- Not for use with dimmers
- Not suitable for outdoor use
- Not suitable for high temperature or damp locations
- Not suitable for heavy air polluted locations
- Please turn off the power before replacing new bulb

CAUTION

- Risk of electric shock
- Use in dry locations only

BOX DIMENSION

- Risk of electric shock
- Use in dry locations only

