



GREENTEK ENERGY SYSTEMS, LLC
www.greentekes.com



P/N:GT-AWP-50W-LJH8bcd-afK-Sg

Note:

GT= Company name,
AWP= Product series,
50W= Rating Power,
L=AC120-277V driver,
J=LED manufacturer,Lumileds 2835,
H8=light distribution type,
“b” can be “P” for DC Photocontrol or blank for not provided,
“c” can be “M”, “DP” for DC Motion Sensor, DC PIR Sensor or blank for not provided,
“d” can be “10SP”, “20SP” for Surge-Protective Device or blank for not provided,
“a” can be any two letters for lamp colors,
“fK” can be any digits for CCT,such as 50K=5000K
S= single color temperature
“g” can be “F” or blank for DC Sensor Power Driver provided or not.

DIMENSIONS

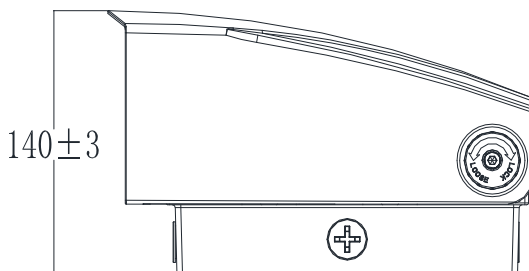
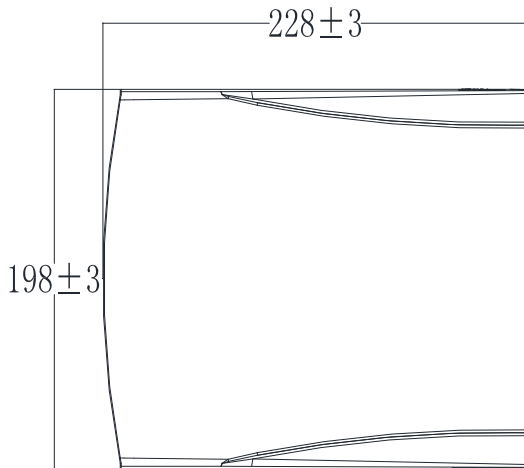

ADVANTAGE

- UL DLC-V5.1(Premium) certificate.
- Lumileds Chip, high CRI.
- Input voltage 120-277VAC.
- Output constant current lever can be adjusted through output cable with 0-10V.
- No UV or IR in the beam.
- Easy to install and operate.
- Energy saving, long lifespan.
- Light is soft and uniform, safe to eyes.
- Instant start, NO flickering, NO humming.
- Green and eco-friendly without mercury.

APPLICATION

- entrance lighting, courtyard lighting.
 - Industrial lighting, Outdoor landscape lighting.
 - Building, The hotel.
- Wall lighting area and so on.

SPECIFICATIONS

OPTICAL	Input Power (Tolerance : ±10%)	50W		
	Color Temperature	4000K	5000K	5700K
	Lumen (Tolerance : -10%)	7049.8LM	7162.7LM	7320.7LM
	Efficacy (Tolerance : -3%)	136.20LM/W	138.38LM/W	142.15LM/W
	CRI	>80		
	Color Consistency	<7 SDCM		
	BUG	B2-U2-G1		
	Distribution Pattern	PC Lens		
	Beam Angle (50%) (Tolerance : ±15%)	90*110 Degree		
ELECTRICAL	Input Voltage and Frequency	120-277VAC, 50/60Hz		
	PF (Tolerance : -3%)	≥0.9		
	THD (Tolerance : +5%)	≤20%		
	Flicker Percent	<80%		
	Driver Brand	HBE (Asmart)		
	Driver Model	HB-LPG060-52		
	Driver Surge protection	L/N-PE: 4kV, L-N: 4kV		
	Dimming	0-10V dimming standard		
	Optional Accessory	Photocontrol, Surge-protective Device, Motion Sensor, Auxiliary		
MATERIALS	LED Brand	Lumileds		
	LED Type	SMD2835		
	LED QTY	85PCS		
	Housing	Die-cast aluminum		
	Housing Color	Brown, Black, or Customized		
	Waterproof Rating	WET (IP65)		
OTHERS	Operating Temperature	-40°C TO 50°C, Sensor : -25°C TO 50°C		
	Storage Temperature	-40°C TO 80°C		
	Operating Humidity	20% - 90% RH		
	Storage Humidity	10% - 95% RH		
	Warranty	5 years		

PACKAGE

	Carton Size	Qty / Carton	Net Weight / Carton	Gross Weight / Carton
Outer box	509*274*396 mm	4PCS	10.1 KG	10.9 KG
Inner box	259*247*188 mm	1 PC	2.2 KG	2.52 KG

Tolerance of Carton Size: ±15 MM, Tolerance of Weight: ±10%.

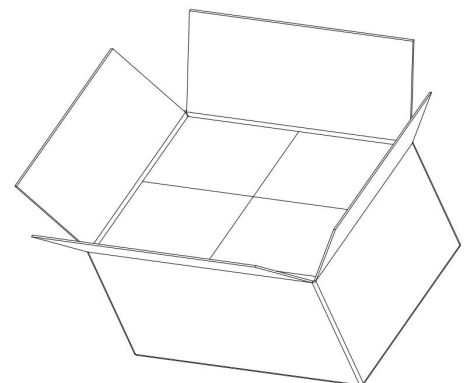
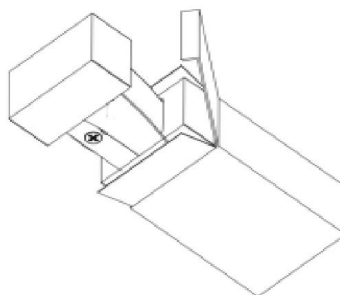
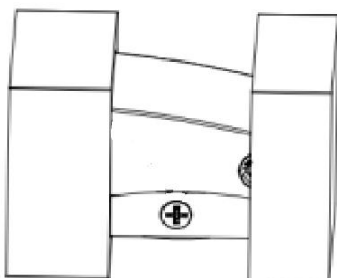

LIGHT DISTRIBUTION TESTING PARAMETERS

Luminaire Property

Luminaire Manufacturer:
 Luminaire Category:
 Lamp Catalog:
 Number of Lamps:
 Luminous Length (mm):
 Luminous Height (mm):
 Current: 0.439 A
 Power Factor: 0.987

Luminaire Description:
 Lamp Description:
 Lumens per Lamp:
 Luminous Width (mm):
 Voltage: 120.0 V
 Power: 52.02 W

Photometric Results

IES Classification: Type II
 Total Rated Lamp Lumens: 6914.3 lm
 Efficiency: 100%
 Upward Ratio: 0%
 C0r0 Intensity: 3091.19 cd
 Pos of Max. Intensity: H90 V21
 Beam Angle(C0/C180,C90/C270,C45/C225,C135/315): 98.2, 75.8, 87.2, 86.0

Longitudinal Classification: Very Short
 Measurement Flux: 6914.3 lm
 Downward Ratio: 100%
 Luminaire Efficacy Rating (LER): 132.97
 Max. Intensity: 3560.18 cd

Luminous Intensity Distribution Curve

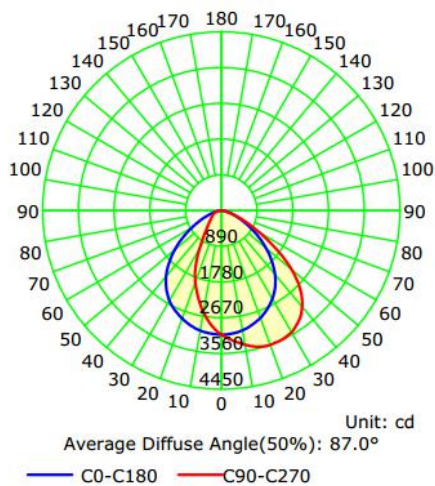

Illuminance at a Distance

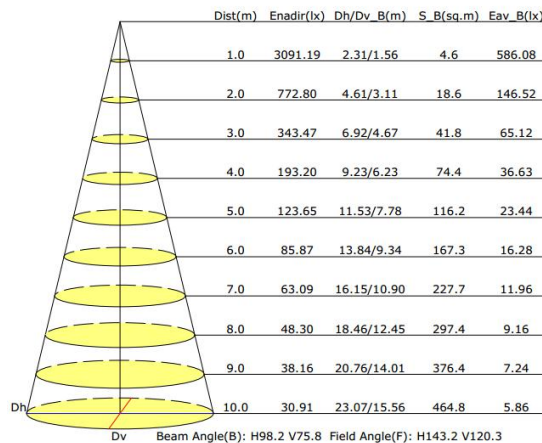

NOTICE FOR USER

- Please turn off power before install or change assembly parts.
- The input voltage and lamps should be matched, after connecting the power line, Please make sure the wiring section is insulated.
- No-professionals, must not install and disassemble the lamps.

TROUBLE SHOOTINGS

Troubles	Check points
Flickering of the light	Turn off the power and turn on again in 3 minutes. If same phenomena occur, then call agencies.
Out of working	Please check the connection.