



GREENTEK ENERGY SYSTEMS, LLC
www.greentekes.com

P/N: GT-AL5-300W-DHibdB3-age

Note:

GT=Company name

AL5=Product series,LED Shoebox Light

300W=wattage;

DH=AC277-480V Dimming driver;

“i” can be “S” or “20SP” for Surge-protective Device type provided or blank for no Surge-Protective Device provided;

“b” can be “3RP”, “P”, “5RP”, “5NP”, “7RP” or “7NP” for Photocontrol type provided or blank for no Photocontrol provided;

“d” can be “DM” “DP” or blank for DC sensor type provided or not;

“B” =Lumileds LED;

“3” =TYPE III;

“a” can be any two letters to represent lamp colors,such as BR=Brown, BH=Black;

“g” can be “XXK” for CCT,

such as 40K=4000K,50K=5000K,57K=5700K;

“e” can be “AM”, “DM”, “YM”, “TR”, “UB”, “FM” for bracket type.

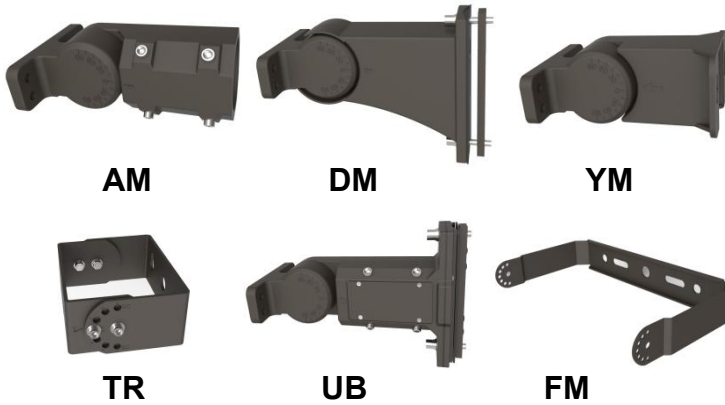

DIMENSIONS

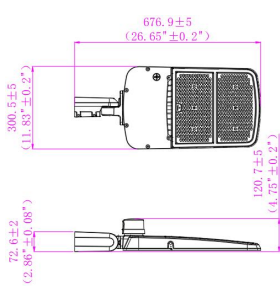

AM

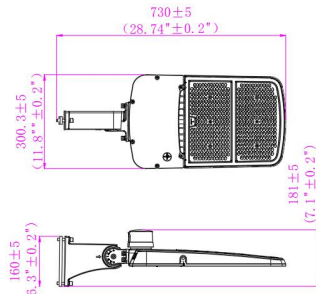

DM

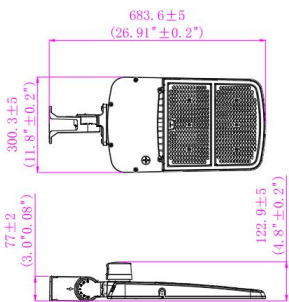

YM

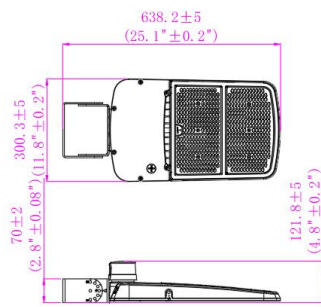

TR

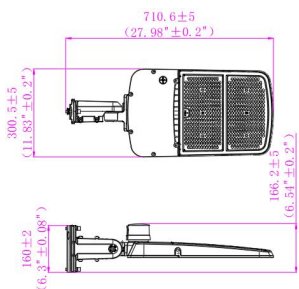

UB

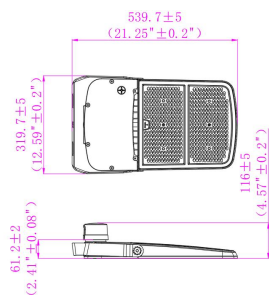

FM

ADVANTAGE

- UL DLC-V5.1(Premium) certificate.
- Lumileds Chip, high CRI.
- Input voltage 277-480VAC.
- Output constant current lever can be adjusted through output cable with 0-10V.
- No UV or IR in the beam.
- Easy to install and operate.
- Energy saving, long lifespan.
- Light is soft and uniform, safe to eyes.
- Instant start, NO flickering, NO humming.
- Green and eco-friendly without mercury.

APPLICATION

- Outdoor basketball court, tennis court.
- Badminton court, the football field.
- The school playground, stadium.
- Community leisure entertainment plaza, road luminaire etc.

SPECIFICATIONS

OPTICAL	Input Power (Tolerance : ±10%)	300W		
	Color Temperature	4000K	5000K	5700K
	Lumen (Tolerance : ±10%)	39126LM	39683LM	40463LM
	Efficacy (Tolerance : ±3%)	130LM/W	132LM/W	134LM/W
	CRI	>80		
	Color Consistency	<6 Steps (or <6 SDCM)		
	BUG	B4-U0-G5		
	Distribution Pattern	Type III		
	Beam Angle (50%) (Tolerance : ±15%)	(153°*108°)		
ELECTRICAL	Input Voltage and Frequency	277-480VAC, 50/60Hz		
	PF (Tolerance : -3%)	≥0.9		
	THD (Tolerance : +5%)	≤20%		
	Flicker Percent	<30%		
	Driver Brand	ASMART		
	Driver Model	R1-V320B-260		
	Driver Surge protection	L/N-PE: 6kV, L-N: 6kV		
	Dimming	0-10V dimming standard		
	Sensor Type	Exterior Photocell, Integral Sensor Receptacle		
Optional Accessory	Photocontrol, Surge-protective Device, photocell receptacle , shorting cap,DC plug light control:			
MATERIALS	LED Brand	Lumileds		
	LED Type	SMD 2835		
	LED QTY	424 PCS		
	Housing	Die-cast aluminum		
	Housing Color	Brown, Black, White or Customized		
	EPA	2.6 ft ²		
	Waterproof Rating	WET (IP65)		
OTHERS	Operating Temperature	-40°C TO 45°C;		
	Storage Temperature	-25°C TO 85°C		
	Operating Humidity	5% - 95% RH		
	Storage Humidity	5% - 95% RH		
	Warranty	5 years		

PACKAGE

Bracket Type	Carton Size	Qty / Carton	Net Weight / Carton	Gross Weight / Carton
AM	755*335*138 mm[29.72*13.19*5.43 in]	1 PC	5.8kg (12.76LBS)	6.8kg (14.96LBS)
DM		1 PC	6.1kg (13.42LBS)	7.1kg (15.62LBS)
YM		1 PC	5.6kg (12.32LBS)	6.6kg (14.52LBS)
TR		1 PC	5.1kg (11.22LBS)	6.1kg (13.42LBS)
UB		1 PC	6.5kg (14.3LBS)	7.5kg (16.5LBS)
FM	685*335*138mm[26.97*13.19*5.43 in]	1 PC	5.4kg (11.88LBS)	6.4kg (14.08LBS)

Tolerance of Carton Size: ±15 mm [±0.59 in], Tolerance of Weight: ±10%.

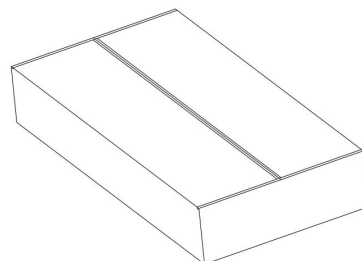
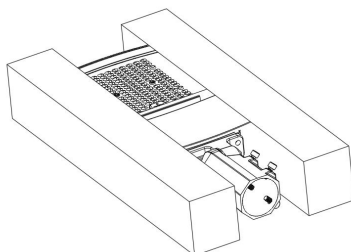

LIGHT DISTRIBUTION TESTING PARAMETERS

NOTICE FOR USER

- Please turn off power before install or change assembly parts.
- The input voltage and luminaire should be matched, after connecting the power line, Please make sure the wiring section is insulated.
- No-professionals, must not install and disassemble the luminaire.

TROUBLE SHOOTINGS

Troubles	Check points
Flickering of the light	Turn off the power and turn on again in 3 minutes. If same phenomena occur, then call agencies.
Out of working	Please check the connection.