

# LED FLOOD LIGHT INSTRUCTIONS

## Cautions:

1. Do not use the electric generator to test the LED light.
2. Please abide by related country, regional and local law and regulations when install this light.
3. Please turn off the power before installation or maintenance.
4. Proper grounding is required to ensure safety.

## Notice:

1. To avoid possibility of electrical shock or fire, the installation personnel must have professional electric knowledge.
2. Please wear gloves to avoid injury before installation.
3. If any smoke or spark of the wire happened, please turn off the power immediately and notify relevant personnel.

## Attention:

1. Please check if there is any damage during shipping. If so, please contact manufacturer timely.
2. Please read the installation instruction carefully to check whether all the accessories are available. After confirmation, install the fixture according to installation steps.

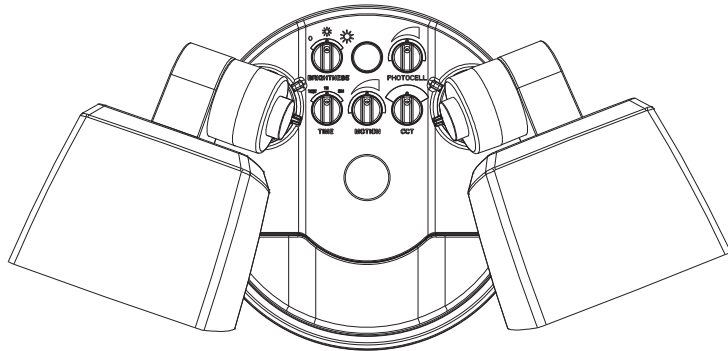

## Installation instruction

1. Turn power off before installation (Figure 1).

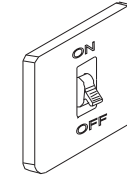

Figure 1

2. Secure the mounting bracket to the junction box with appropriate screws (Figure 2).

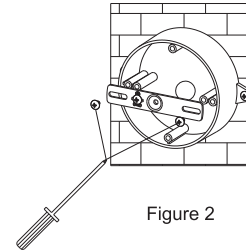

Figure 2

3. Attach the pad on the bottom of the light, and hang the light on the bracket through the hanging rope (Figure 3).

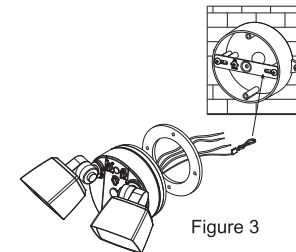

Figure 3

4. Connect the wires to the main properly and make good protection (Figure 4).

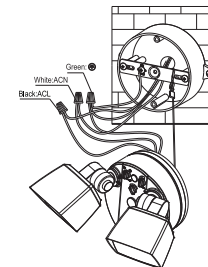

Figure 4

5. Remove the rubber cap and fasten the light to the bracket with screws (Figure 5).

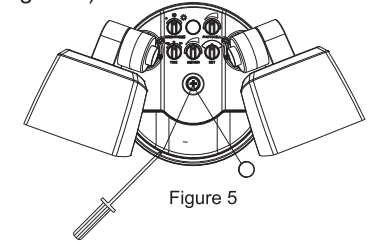

Figure 5

6. Put the rubber cap back (Figure 6).

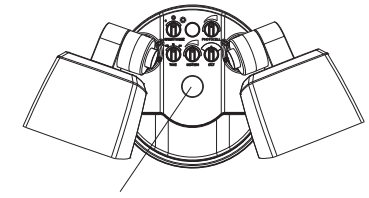

Figure 6

7. Make sure installation is complete before turning on the power (Figure 7).

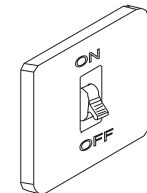
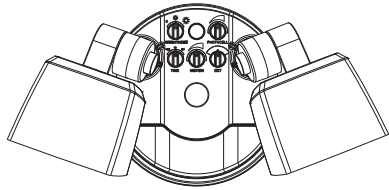

Figure 7

8. After installation, calk all the mounting surface.



# SPECIAL FUNCTIONS INSTRUCTION

## LED flood light with PIR sensor



1. All lights are off at daytime.
2. When the night light is at ON state, it will turn on automatically at dusk.
3. Both led lights will turn on when motion is detected from dusk to dawn.



1. When the brightness is set at , the night light is at OFF state, both led lights are at maximum wattage.
2. When the brightness is set at , the night light is at ON state, both led lights are at minimum wattage.
3. When the brightness is set at , the night light is at ON state, both led lights are at maximum wattage.

**Photocell:** senses the amount of daylight and prevents the led light from being activated by daylight at daytime.

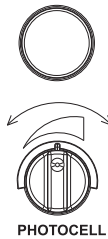

When the knob is adjusted to the far left, stronger daylight is required to activate the photocell, and when it is adjusted to the far right, less daylight is required to activate the photocell.

1. When it's set to TEST, the light is under test mode.
2. When it is adjusted to 1M, after the movement stops, the holdtime of the light is 1 minute.
3. When it is adjusted to 5M, after the movement stops, the holdtime of the light is 5 minute.

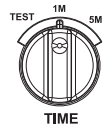

**Motion sensitivity adjustment:** when adjusted to the leftmost side, motion detection is not sensitive; when adjusted to the rightmost, motion detection is the most sensitive.

