

# LED Shoebox Light Instruction

Rev:A2 80417

## Cautions:

1. Do not use the electric generator to test the LED Light.
2. Please abide by related country, regional and local law and regulations when install this fixture.
3. To avoid electrical shock and damage, please do not install the lights in raining days.

## Notices:

1. To prevent from electric shock or fire risk, the installation must be conducted by operator who have professional electrical knowledge.
2. Please wear gloves to avoid injury before installing Light.
3. During or after installation, if there are situations such as smoke, fire in the wires or Light, please turn off the power immediately and notify relevant personnel of an overhaul.
4. This light can be used for outdoor installation.
5. Do not install in a hazardous environment. The ambient temperature must not exceed the rated operating temperature of the product.
6. Do not install the product when it rains. Avoid the danger of lightning strikes and avoid accidents.
7. External 0-10V only passive dimmers are supported.

## General Wiring Diagram

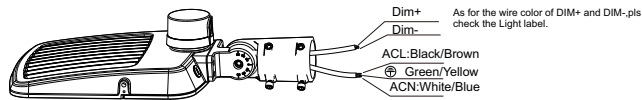

Notice: Please use the dimming+, dimming- (DC10V) marking leads to connect to outside dimmer. Class 1 Wiring Only. Please assure a cumulative leakage current of less than 3.5mA on the control circuit. The AUX control wire with shrinkable tubing shall not be damaged (no connection).

## Optional Brackets and Installation Instructions:

There are 6 optional brackets for this fixture. The following is street light fixtures with different brackets

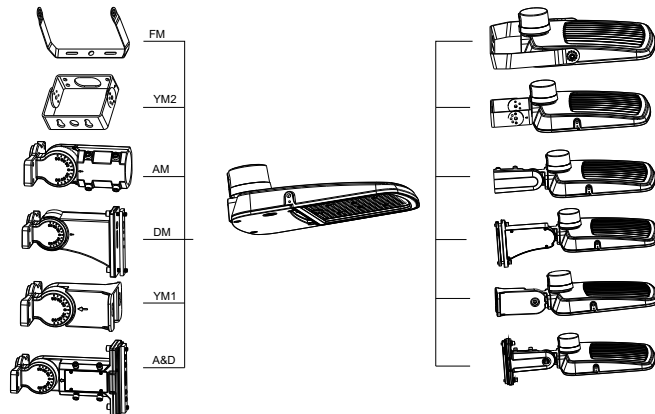

## Installation Instructions with different brackets:

### 1.FLOOD MOUNTING (e=FM)

Step 1: First install two bigscrews. (Figure 1)

Step 2: Install two small screws. (Figure 2)

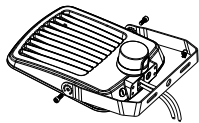

Figure 1

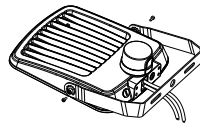

Figure 2

### 2.ADJUSTABLE FITTER MOUNTING (AM)

Step 1: Remove the bracket mounting screws on the fixture and run the wires through the bracket. (Figure 3)

Step 2: Install the bracket on the fixture. (Figure 4)

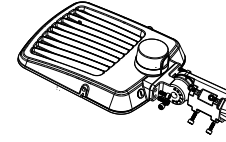

Figure 3

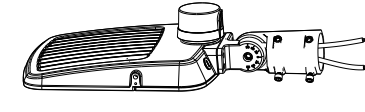

Figure 4

### 3.DIRECT MOUNTING (DM)

Step 1: Remove the bracket mounting screws on the fixture, open the side lid of bracket and run the wires through the bracket. (Figure 5)

Step 2: Install the bracket on the fixture, then cover the side lid and tighten it. (Figure 6)

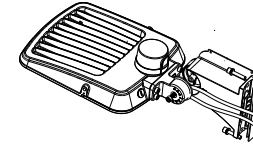

Figure 5

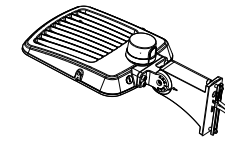

Figure 6

### 4.YOKE MOUNTING (YM1)

Step 1: Remove the bracket mounting screws on the fixture and run the wires through the bracket. (Figure 7)

Step 2: Install the bracket on the fixture(Figure8).

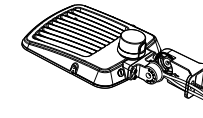

Figure 7

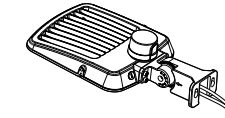

Figure 8

### 5.ADJUSTABLE FITTER MOUNTING & DIRECT MOUNTING (A&D)

Step 1: Remove the bracket mounting screws on the fixture, open the side lid of bracket and run the wires through the bracket. (Figure 9)

Step 2: Install the bracket on the fixture, then cover the side lid and tighten it(Figure10).

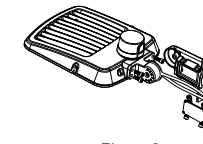

Figure 9

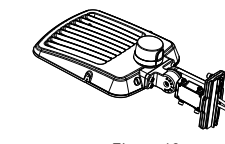

Figure 10

### 6. YOKE MOUNTING (e=YM2)

Step 1: Remove the bracket mounting screws on the fixture and run the wires through the bracket. (Figure 11)

Step 2: Install the bracket on the fixture. (Figure 12)

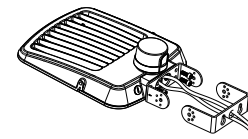

Figure 11

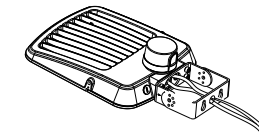

Figure 12

Installation of LED Light

1. ADJUSTABLE FITTER MOUNTING (e=AM)

Step 1: Loosen the four bolts on AM bracket, connect the wires correctly, and pull the wires into the poles.(Figure 13)

Step 2: Place the bracket into the pole and lock the four bolts.(Figure 14)

Notice: Adjustable angle is 0-90°

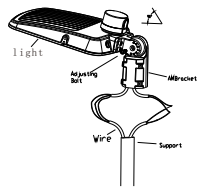

Figure 13

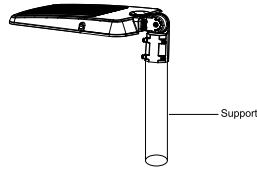

Figure 14

2. DIRECT MOUNTING (e=DM)

Step 1: Fix DM bracket to square pole with bolt, open the side lid of DM bracket, pull the wire into junction box, and connect the wire correctly. (Figure 15)

Step 2: Put the connected wire into the junction box, then cover the junction box.(Figure 16)

Notice: Adjustable angle is 0-35°(Figure 15).

Same as round pole installation, please remember to remove the silicon plate when install the fixture in round pole( Figure 17)

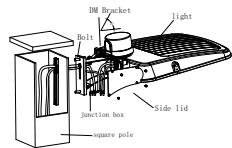

Figure 15

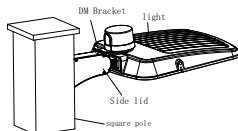

Figure 16

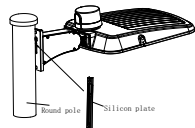

Figure 17

3. YOKE MOUNTING (e=YM1)

Step 1: Drill holes on the wall as shown. (Figure 18)

Step 2: Knock the expansion bolts into the wall.(Figure 19)

Step 3: Connect the fixture to the bracket and tighten the screws; connect the wires properly and put them into junction box.(Figure 20)

Notice: Adjustable angle is 0-90°(Figure 20)

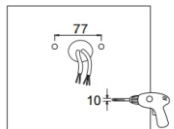

Figure 18

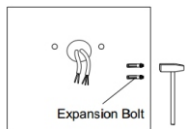

Figure 19

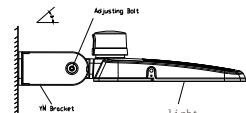

Figure 20

4. YOKE MOUNTING (e=YM2)

Step 1: Drill holes on the wall as shown. (Figure 21)

Step 2: Knock the expansion bolts into the wall.(Figure 22)

Step 3: Connect the fixture to the bracket and tighten the screws; connect the wires properly and put them into junction box.(Figure 23)

Notice: Adjustable angle is 0-90°(Figure 23)

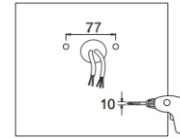

Figure 21

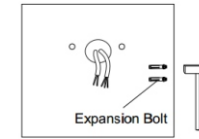

Figure 22

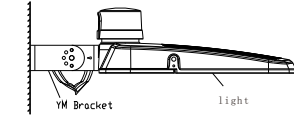

Figure 23

5. ADJUSTABLE FITTER MOUNTING& DIRECT MOUNTING (e=A&D)

5.1 ADJUSTABLE FITTER MOUNTING

Step 1: Remove the spare parts from A&D bracket. (Figure 24)

Step 2: Loosen the four bolts on A&D bracket, connect the wires correctly, and pull the wires into the poles.(Figure 25)

Step 3: Placethe bracket into the pole and lock the four bolts. (Figure 25)

Notice:Adjustable angle is 0-90°(Figure 25)

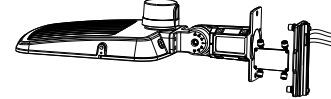

Figure 24

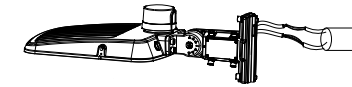

Figure 25

6. FLOOD MOUNTING (e=FM)

Install the mount to the fixture, tighten the mount and install the screws.

Connect the fixture to the bracket and tighten the screws; connect the wires properly and put them into junction box( Figure 26)

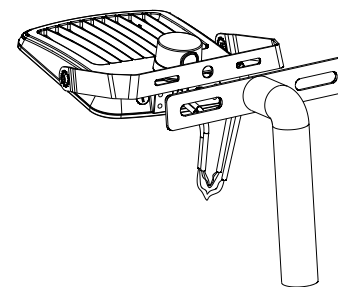
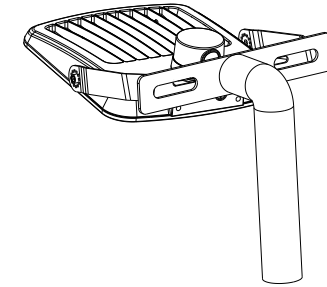

Figure 26



When the photocell function is required, photocell should be installed on the back of lamp; When it's not required, shorting cap should be installed on the back of lamp.(Figure 27)

Instructions for Photocell

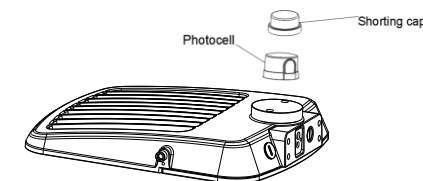

Figure 27