

- In addition to routine checks for each use, PPE should regularly undergo a detailed inspection by a competent person. Petzl recommends an inspection every 12 months and after any exceptional event in the life of the product.
 - PPE inspection should be conducted with the manufacturer's Instructions for Use.
- Download the instructions at [PETZL.COM](https://www.petzl.com).

JAG RESCUE KIT



1. Known product history

Any PPE showing unexpected degradation should be quarantined, pending a detailed inspection.

The user should:

- Provide precise information on the usage conditions.
- Report any exceptional event regarding his PPE.

(Examples: fall or fall arrest, use or storage at extreme temperatures, modification outside manufacturer's facilities...).

2. Preliminary observations

Verify the presence and legibility of the serial number and the CE mark.

Attention, the serial number code on our products is evolving. Two types of code will coexist. See below for details on each serial number code.

Code A:

00 000 AA 0000

Year of manufacture
Day of manufacture
Name of Inspector
Incrementation

Code B:

00 A 0000000 000

Year of manufacture
Month of manufacture
Batch number
Incrementation

Verify that the product lifetime has not been exceeded.

Compare with a new product to verify there are no modifications or missing parts.

3. Inspection of all components

Carry out the inspection of each component separately, using the dedicated procedures available at Petzl.com.

The inspection may be done without dismantling the kit, by simply moving aside components that are hiding any parts to be inspected (e.g. rope in the I'D).

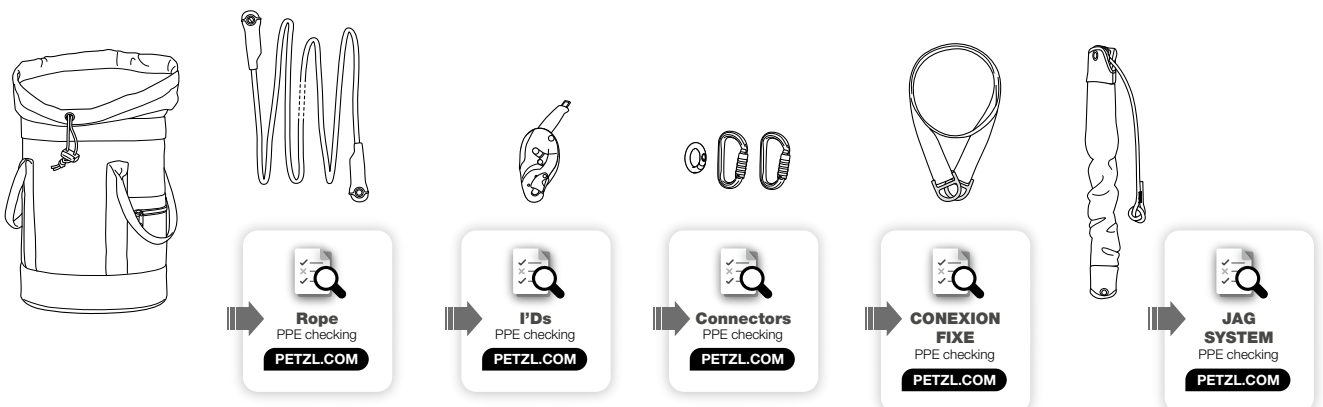

If the kit has been dismantled in use or if a special inspection requires dismantling the kit's components, follow the assembly and repacking instructions beginning with chapter 4.

4. Reassembling the JAG RESCUE KIT

- Verify that the rope length is marked on a label on the rope. Verify that the length marked on the bag matches the length marked on the rope.

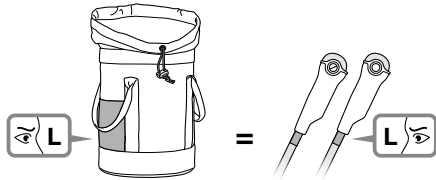

- Pack the rope in the bag, red sleeve first.

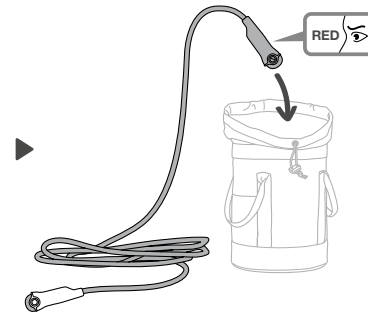

- Install a connector on the white sleeve end of the rope.

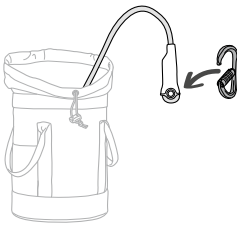

- Open the I'D S and put the handle in the belaying position. Install the rope in the I'D S with the white sleeve on the anti-error catch side.

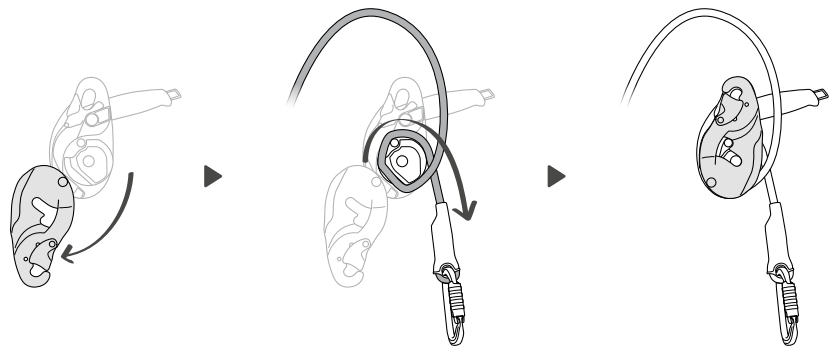

- Lock the moving side plate on the I'D S with the side plate locking screw.

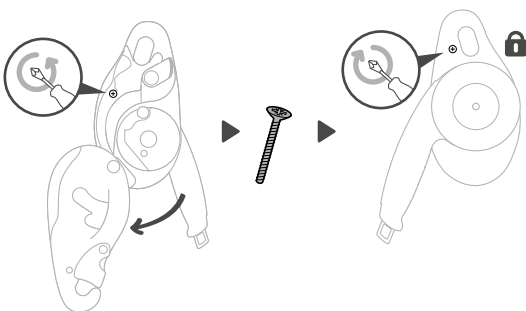

- Install the RING OPEN on the JAG SYSTEM (JAG pulley side). Insert the pulley side plates and the edges of the cover, one after another, into the opening.

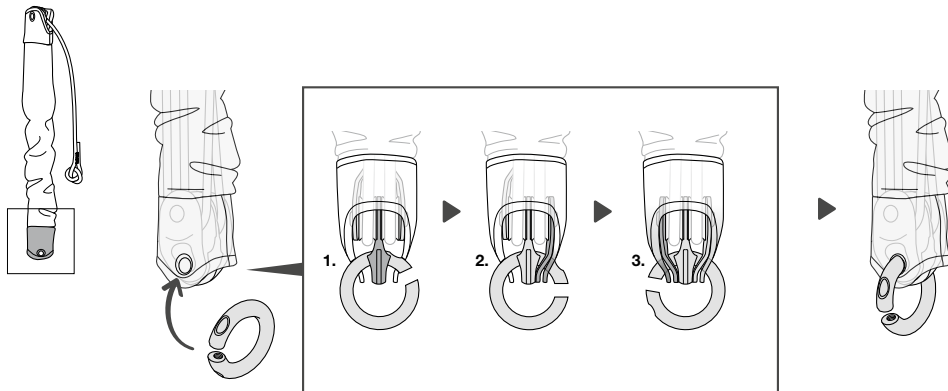

- Pass the red sleeve (bag) end of the rope through the RING OPEN and attach the I'D S to the RING OPEN. Close and lock the RING OPEN.

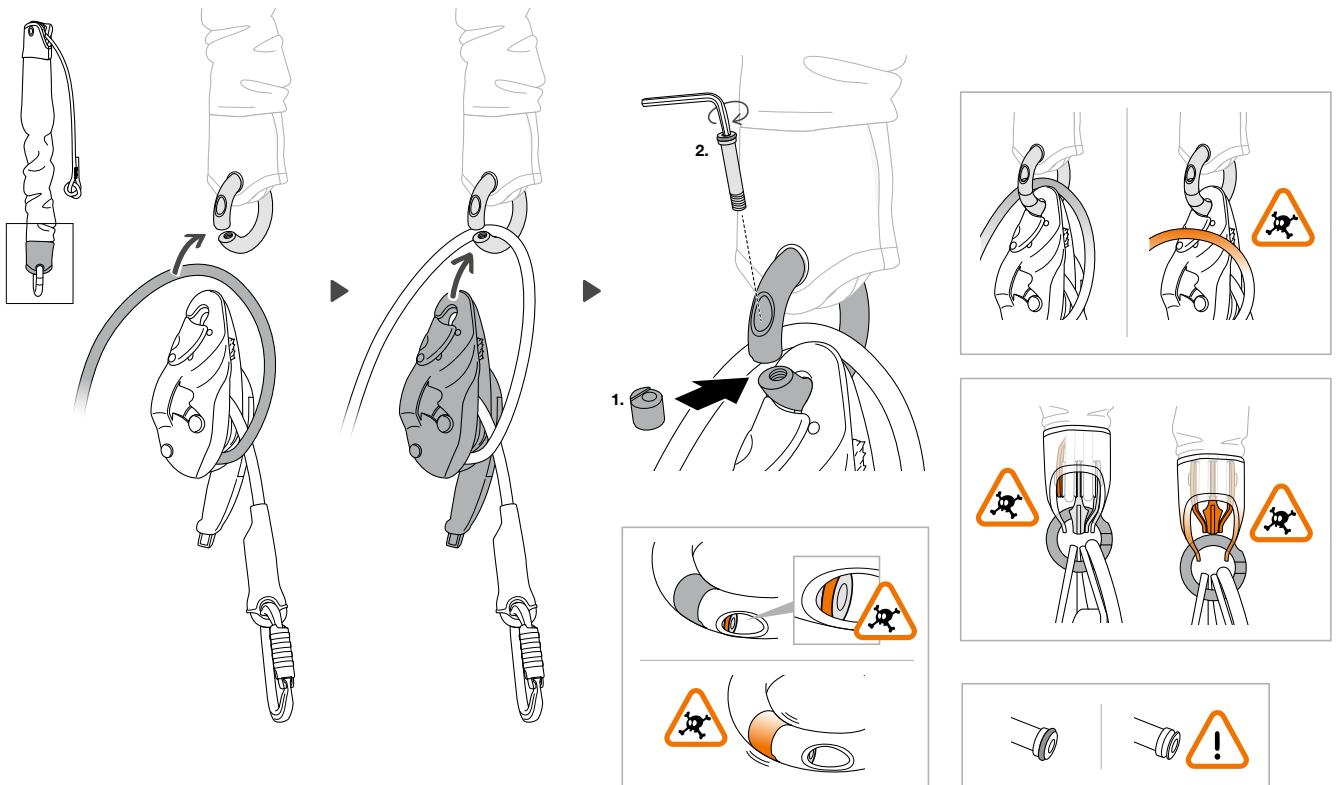

- Connect the JAG SYSTEM (JAG TRAXION progress-capture pulley side) to one end of the CONNEXION FIXE anchor strap.

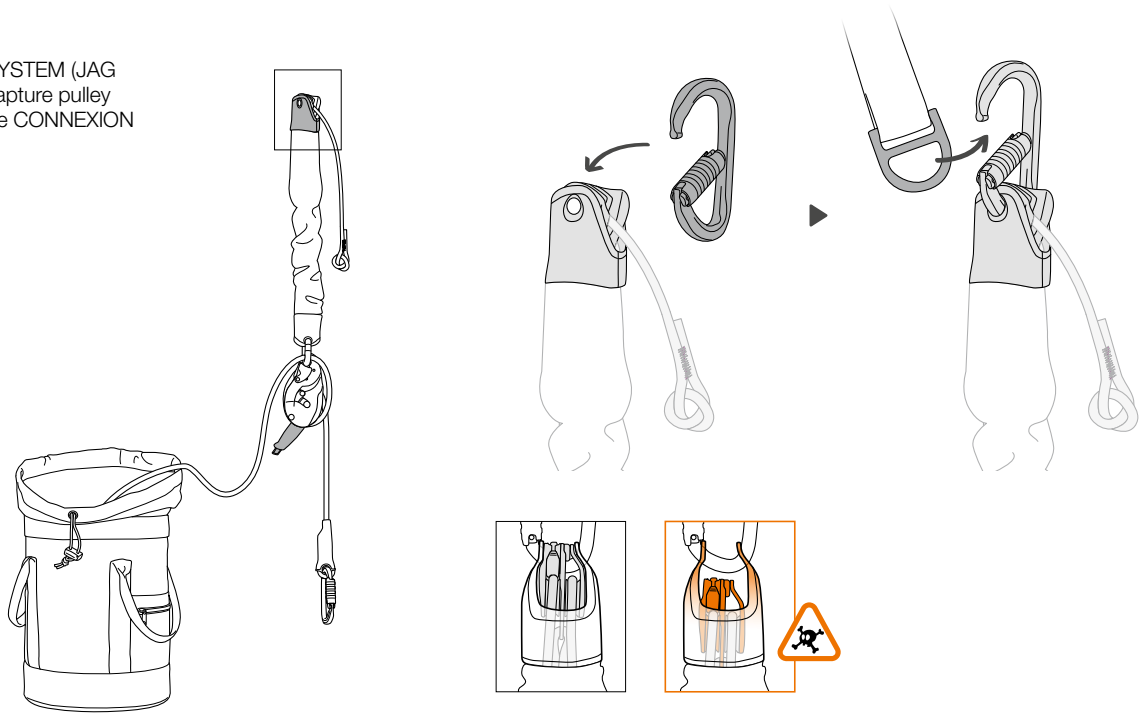

5. Function check

Install your CONNEXION FIXE to an anchor at low height, with a light load on the white sleeve end of the rope.

- Verify that the system locks under load.
- Verify that it is possible to haul the load with the JAG SYSTEM.
- Verify that it is possible to lower the load with the I'D S.

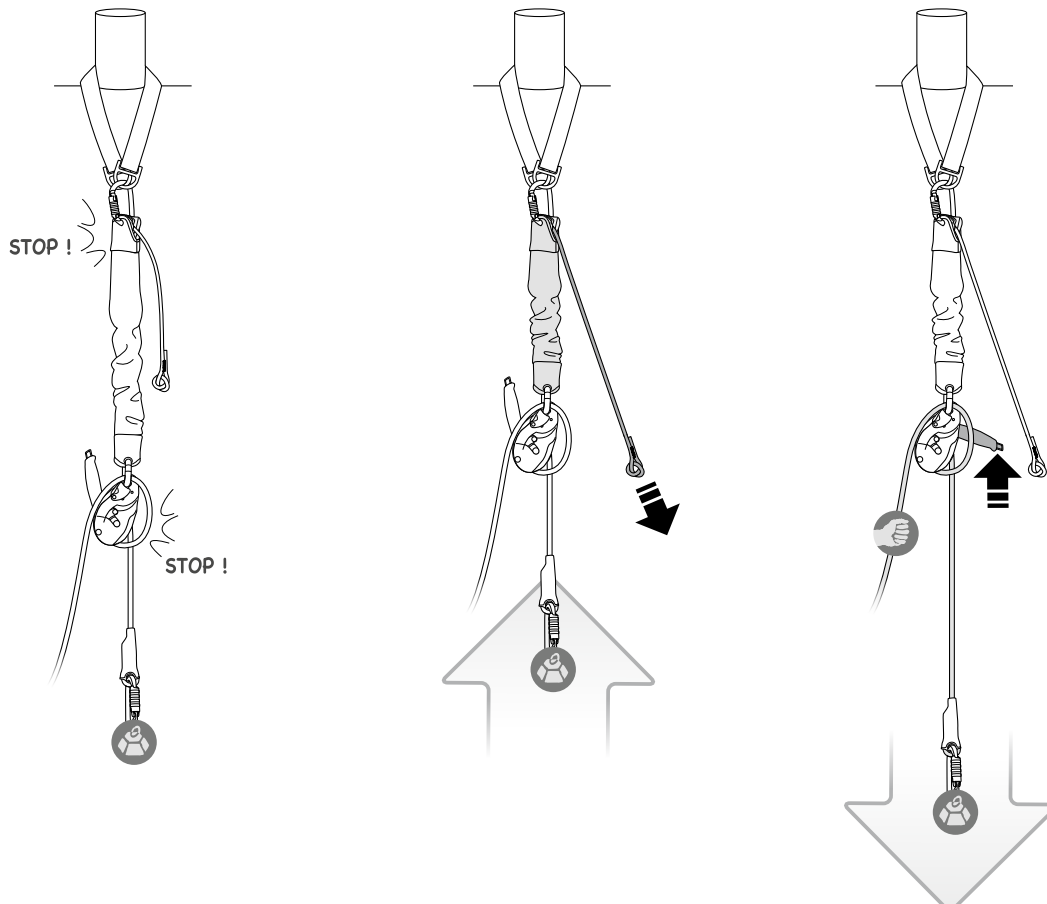

6. Final packing

- Temporarily deactivate the JAG TRAXION cam and slide the cord through to set the JAG SYSTEM at maximum length. Reactivate the JAG TRAXION cam.

- Slide rope through to position the white sleeve as close as possible to the I'D S.
- Put the I'D S handle in LOCK position.

- Put everything in the bag, close, mark and seal according to your needs.

