



Instructions for the following series products:

Rebar Lanyards for Work Positioning
(See back page for specific model numbers.)

**USER INSTRUCTION MANUAL
REBAR LANYARDS FOR WORK POSITIONING**

This manual is intended to meet the Manufacturer's Instructions as recommended by OSHA and should be used as part of an employee training program.

WARNING: This product is part of a work positioning system. These instructions must be provided to the user and the rescuer (see section 8 Terminology). The user must read and understand these instructions before using this equipment. The user must follow the manufacturer's instructions for each component of the system. Manufacturer's instructions must be followed for proper use and maintenance of this equipment. Alterations or misuse of this equipment, or failure to follow instructions, may result in serious injury or death.

IMPORTANT: If you have questions on the use, care, or suitability of this equipment for your application, contact DBI-SALA.

IMPORTANT: Before using this equipment, record the product identification information from the ID label into the inspection and maintenance log in section 9.0 of this manual.

Figure 1 - Rebar Lanyards for Work Positioning

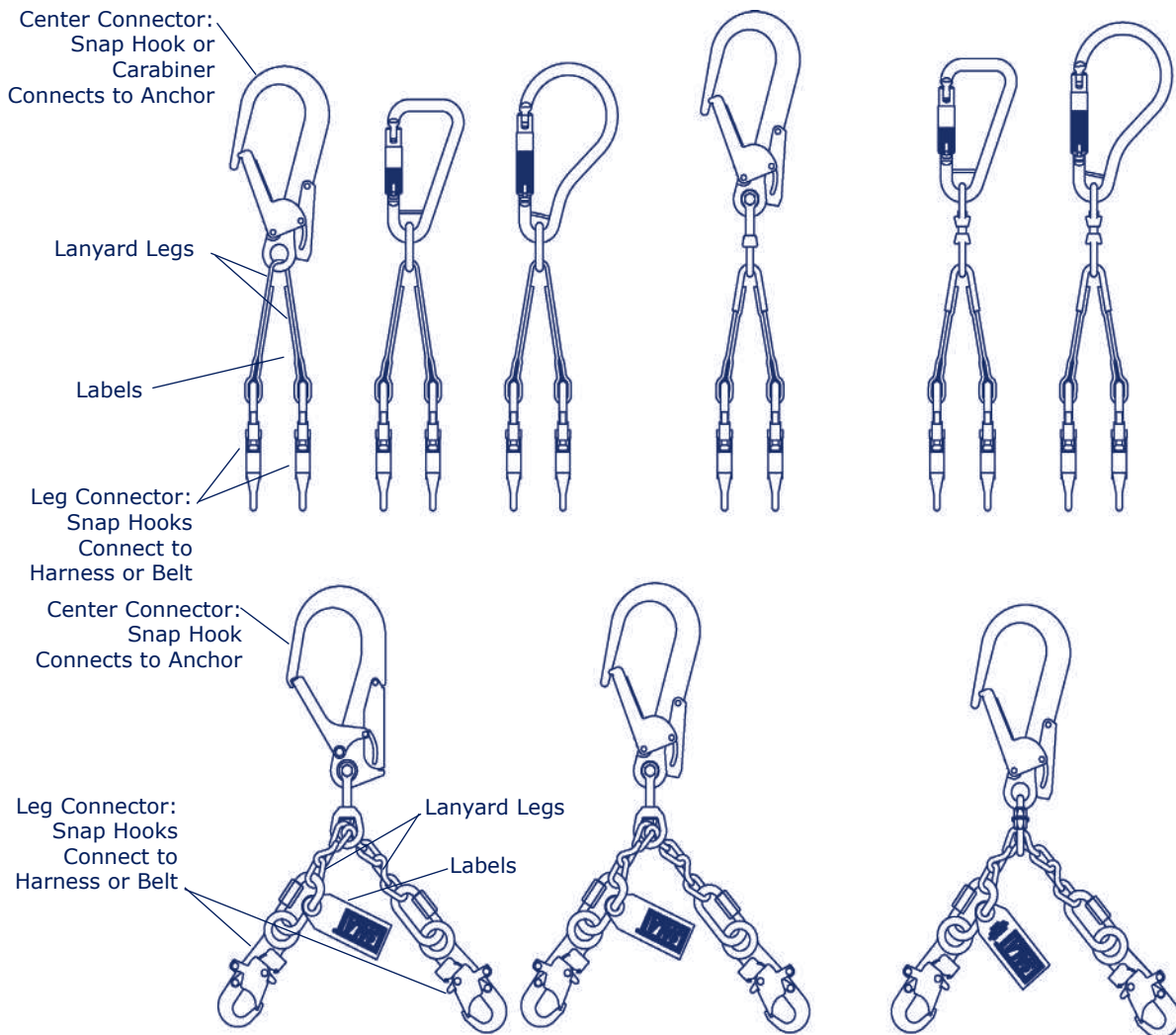

DESCRIPTIONS

The following options are available for positioning lanyards:

DOUBLE LEG REBAR LANYARDS

Legs: Web or Chain

Connection between legs and center: O-ring or swivel

Connectors:

Leg: 9503175 snap hook, 9500100 swivel snap hook, 9510057 flat snap hook, 2000000 clevis snap hook, 9502116 3600 lb. gate snap hook, 2109193 3600 lb gate flat snap hook, 9502156 3600 lb. gate clevis snap hook.

Center: 2007153 snap hook, 9502058 3,600 lb. gate snap hook, 2000106 carabiner, 2000108 carabiner.

SINGLE LEG REBAR LANYARDS

Legs: Web or Chain

Connection between legs and center: O-ring or swivel

Connectors:

Leg: 9503175 snap hook, 9500100 swivel snap hook, 9510057 flat snap hook, 2000000 clevis snap hook, 9502116 3600 lb. gate snap hook, 2109193 3600 lb gate flat snap hook, 9502156 3600 lb. gate clevis snap hook.

Center: 2007153 snap hook, 9502058 3,600 lb. gate snap hook, 2000106 carabiner, 2000108 carabiner.

1.0 APPLICATIONS

1.1 PURPOSE: The rebar lanyards are intended to be used as part of work positioning system that holds and supports the user at a work location. Applications include concrete rebar assembly and steel erection. OSHA standard 1926.500 defines this equipment as part of a positioning device system.

1.2 LIMITATIONS: Consider the following application limitations before using this equipment:

- A. CAPACITY:** This equipment is designed for use by persons with a combined weight (including tools, clothing, etc.) of no more than 310 lbs.
- B. FREE FALL:** This equipment must be rigged to limit the potential free fall to 2 feet, according to OSHA 1926.502.
- C. FALL CLEARANCE:** Ensure that adequate clearance exists in your fall path to prevent striking an object. The clearance required is dependent on the length and type of lanyard and anchorage location.
- D. PERSONAL FALL ARREST SYSTEM:** See Figure 2. DBI-SALA recommends the use of a personal fall arrest system with this equipment. The personal fall arrest system will protect the user if the work positioning system disengages from the anchorage point, or when detached from the work positioning system when moving from point to point. See OSHA 1926.501 and 1926.1053.
- E. ENVIRONMENTAL HAZARDS:** Use of this equipment in areas where environmental hazards are present may require additional precautions to reduce the possibility of injury to the user or damage to the equipment. Hazards may include, but are not limited to; high heat, severe cold, caustic chemicals, corrosive environments, high voltage power lines, explosive or toxic gases, moving machinery, or sharp edges.
- F. TRAINING:** This equipment is intended to be used by persons trained in its correct application and use.

1.3 APPLICABLE STANDARDS: Refer to national standards, including the ANSI Z359 family of standards on fall protection, ANSI A10.32, and applicable local, state, and federal (OSHA) requirements governing occupational safety, for more information on work positioning systems.

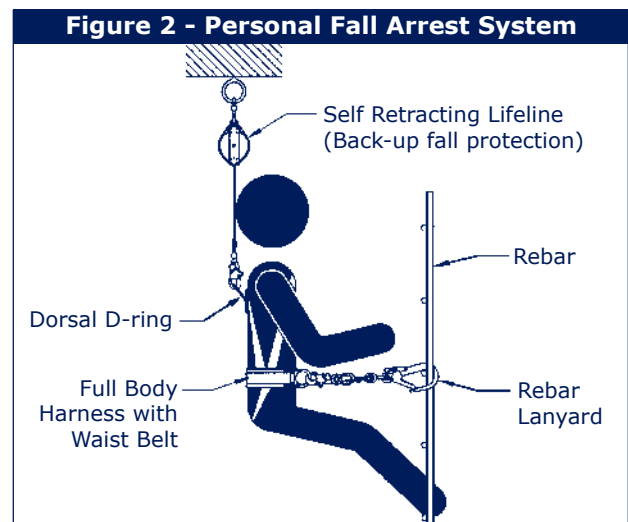

2.0 SYSTEM REQUIREMENTS

2.1 COMPATIBILITY OF COMPONENTS AND SUBSYSTEMS: This equipment is designed for use with DBI-SALA approved components and subsystems. Substitutions or replacements made with non-approved components or subsystems may be incompatible, and may jeopardize the safety and reliability of the complete system.

2.2 COMPATIBILITY OF CONNECTORS: Connectors are considered to be compatible with connecting elements when they have been designed to work together in such a way that their sizes and shapes do not cause their gate mechanisms to inadvertently open regardless of how they become oriented. Contact DBI-SALA if you have any questions about compatibility.

Connectors (hooks, carabiners, and D-rings) must be capable of supporting at least 5,000 lbs. (22.2 kN). Connectors must be compatible with the anchorage or other system components. Do not use equipment that is not compatible. Non-compatible connectors may unintentionally disengage. See Figure 3. Connectors must be compatible in size, shape, and strength. Self locking snap hooks and carabiners are required by ANSI Z359.1, OSHA, and CSA Z259.12.

Figure 3 - Unintentional Disengagement (Roll-out)

If the connecting element that a snaphook (shown) or carabiner attaches to is undersized or irregular in shape, a situation could occur where the connecting element applies a force to the gate of the snaphook or carabiner. This force may cause the gate (of either a self-locking or a non-locking snaphook) to open, allowing the snaphook or carabiner to disengage from the connecting point.

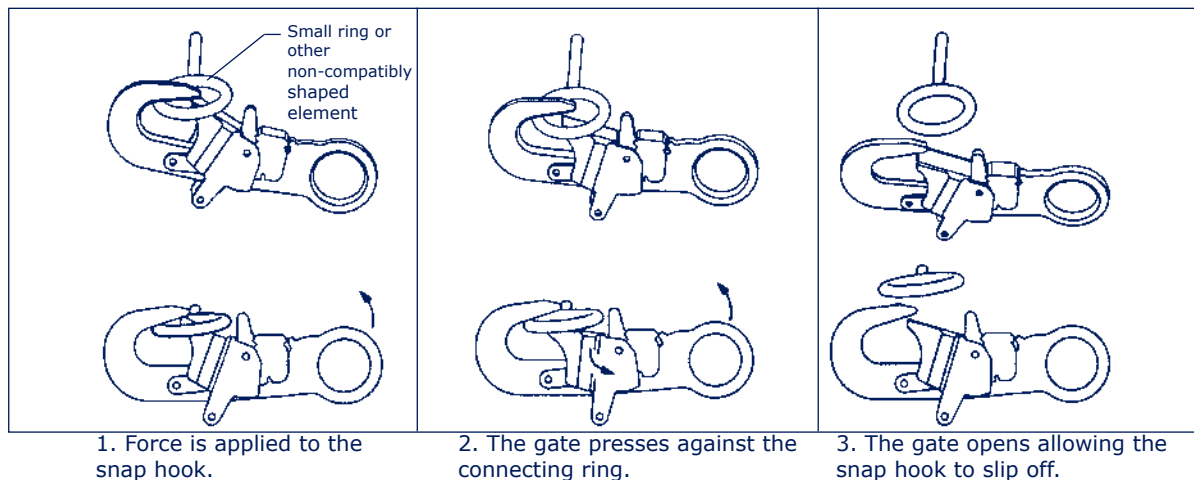

2.3 MAKING CONNECTIONS: Only use self-locking snap hooks and carabiners with this equipment. Only use connectors that are suitable to each application. Ensure all connections are compatible in size, shape and strength. Do not use equipment that is not compatible. Ensure all connections are fully closed and locked .

DBI-SALA connectors (snap hooks and carabiners) are designed to be used only as specified in each product's user's instructions. See Figure 4 for inappropriate connections. DBI-SALA snap hooks and carabiners should not be connected:

- A. To a D-ring to which another connector is attached.
- B. In a manner that would result in a load on the gate.

NOTE: Large throat opening snap hooks should not be connected to standard size D-rings or similar objects which will result in a load on the gate if the hook or D-ring twists or rotates. Large throat snap hooks are designed for use on fixed structural elements such as rebar or cross members that are not shaped in a way that can capture the gate of the hook.

- C. In a false engagement, where features that protrude from the snap hook or carabiner catch on the anchor and without visual confirmation seems to be fully engaged to the anchor point.
- D. To each other.
- E. Directly to webbing or rope lanyard or tie-back (unless the manufacturer's instructions for both the lanyard and connector specifically allows such a connection).

- F. To any object which is shaped or dimensioned such that the snap hook or carabiner will not close and lock, or that roll-out could occur.

2.4 ANCHORAGE STRENGTH: Anchorages selected for work positioning systems shall have a strength capable of sustaining static loads applied in the directions permitted by the system of at least: A) 3,000 pounds (13.3kN) for non-certified anchorages or B) Two times the foreseeable force for certified anchorages (see section 8 Terminology).
When more than one work positioning system is attached to an anchorage, the strengths previously set forth in (A) and (B) shall be multiplied by the number of systems attached to the anchorage.

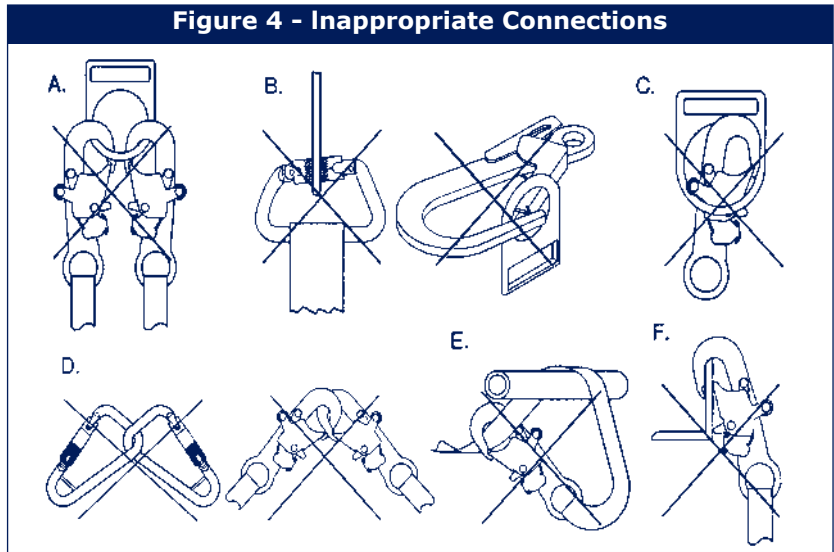

WARNING: Do not alter or intentionally misuse this equipment. Consult DBI-SALA when using this equipment in combination with components or subsystems other than those described in this manual. Some subsystem and component combinations may interfere with the operation of this equipment. Use caution when using this equipment around moving machinery and electrical hazards. Do not loop the lanyard around small structural members.

WARNING: Consult your doctor if there is reason to doubt your fitness to safely absorb the shock from a fall arrest. Age and fitness seriously affect a worker's ability to withstand falls. Pregnant women or minors must not use DBI-SALA rebar lanyards.

3.0 USE

3.1 BEFORE EACH USE of this equipment, carefully inspect it according to steps listed in section 5 of this manual.

3.2 PLAN your work positioning system before using this equipment. Consider all factors that will affect your safety during use of this equipment. Consider the following when planning your system:

- A. **HAZARD EVALUATION:** Evaluate the job site for all possible hazards. Ensure the intended path of the user is unobstructed. See section 1.2 for more information.
- B. **BODY SUPPORT:** DBI-SALA recommends the use of a full body harness with this equipment. A body belt may be used when it is a part of a full body harness.
- C. **BACK-UP FALL PROTECTION:** DBI-SALA recommends the use of a personal fall arrest system with this equipment. See section 1.2 and Figure 2 for more information. Use the personal fall arrest system according to manufacturer's instructions.
- D. **RESCUE:** The authorized person must have a rescue plan and the means at hand to implement it when using this equipment where a suspension could occur (such as following a fall and self-rescue is not possible).

3.3 MAKING CONNECTIONS: When using a hook to connect to an anchorage, ensure roll-out cannot occur. Roll-out occurs when interference between the hook and mating connector causes the hook gate to unintentionally open and release. Self-locking snap hooks and carabiners should be used to reduce the possibility of roll-out. Make sure all connectors close and lock and they do so automatically without manual assistance. Do not use hooks or connectors that will not completely close over the attachment object. Do not connect snap hooks or carabiners to each other.

3.4 CONNECTING THE REBAR LANYARD TO YOUR BODY SUPPORT AND ANCHORAGE:

A. CONNECTING TO YOUR BODY SUPPORT: See Figure 5.

Double Leg Rebar Lanyards: Connect one leg of the rebar lanyard to each side D-ring of your body support (full body harness).

Single Leg Rebar Lanyards with D-ring: Lace your waist belt through the D-ring on the rebar lanyard. With the D-ring installed, buckle and secure your waist belt.

Figure 5 - Connecting To Your Body Support

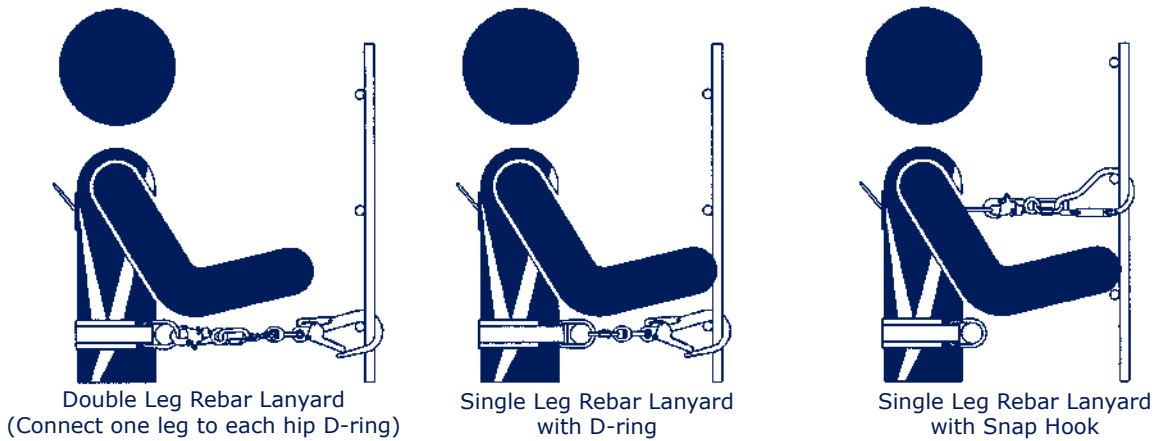

Single Leg Rebar Lanyards with Snap Hook: Connect the snap hook to the front D-ring on your cross-over style full body harness. If using this rebar lanyard with a waist belt, slide the waist belt D-ring to your front and connect the snap hook.

- B. CONNECTING TO THE ANCHORAGE:** Connect the snap hook or carabiner on the rebar lanyard to the intersection of the horizontal and vertical rebar as shown in Figure 6.
- C. CONNECTING THE PERSONAL FALL ARREST SYSTEM:** Connect the personal fall arrest system to the dorsal back D-ring on your full body harness. See Figure 2. See personal fall arrest system manufacturer's instructions for more information.

Figure 6 - Connecting To The Anchorage

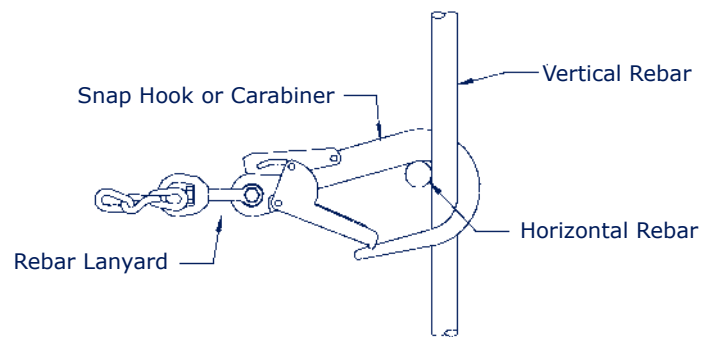

Connect Snap Hook or Carabiner to the intersection of the horizontal and vertical rebar

4.0 TRAINING

- 4.1** It is the responsibility of the user to assure they are familiar with these instructions, and are trained in the correct care and use of this equipment. User must also be aware of the operating characteristics, application limits, and the consequences of improper use of this equipment.

WARNING: Training must be conducted without exposing the trainee to a fall hazard. Training should be repeated on a periodic basis.

5.0 INSPECTION

5.1 FREQUENCY:

- **Before Each Use** inspect according to steps listed in section 5.2. Remove equipment from field service if it has been subjected to damage or has been subjected to a fall arrest force.
- **Annually:** This equipment must be inspected according to steps listed in section 5.2 by a competent person, other than the user, at least annually. Record the results of each inspection in the inspection and maintenance log in section 9.0.

WARNING: If this equipment has been subjected to fall arrest forces, remove from service and destroy.

IMPORTANT: Extreme working conditions (harsh environments, prolonged use, etc.) may require increasing the frequency of inspections.

5.2 INSPECTION STEPS:

Step 1. Inspect rebar lanyard hardware (snap hooks, carabiners, quick-links, etc.) for damage, distortion, sharp edges, worn parts, or corrosion. The snap hooks or carabiners must work properly. Hook gates must move freely and lock upon closing.

Step 2. Inspect the lanyard material as applicable:

WEBBING AND STITCHING: Webbing must be free of frayed, cut, or broken fibers. Webbing must be free of knots, tears, abrasions, mold, or discoloration. Webbing must be free of chemical or heat damage, indicated by brown, discolored, or brittle areas. Webbing must be free of ultraviolet damage, indicated by discoloration and splinters along the webbing surface. Stitching must be free of pulled or cut stitches. All of the above factors are known to reduce webbing strength.

CHAIN: Inspect chain for damage, distortion, sharp edges, worn links, or corrosion.

Step 3. Labels must be present and fully legible. See section 9.0.

Step 4. Inspect each system component and subsystem according to manufacturer's instructions.

Step 5. Record inspection date and results in the inspection and maintenance log in section 9.0.

5.3 If inspection reveals an unsafe or defective condition, remove rebar lanyard from service and destroy, or contact an authorized service center for repair.

IMPORTANT: Only DBI-SALA or an authorized service center may make repairs to this equipment.

6.0 MAINTENANCE, SERVICING, STORAGE

6.1 Clean the rebar lanyard with water and mild detergent. Wipe off hardware with a clean, dry cloth and hang to air dry. Do not force dry with heat. An excessive build-up of dirt, paint, etc., may prevent the rebar lanyard from working properly, and in severe cases, weaken the webbing. If you have questions about the condition of your rebar lanyard, contact DBI-SALA.

6.2 Additional maintenance and servicing procedures must be completed by DBI-SALA or parties authorized in writing. Do not disassemble this equipment. See section 5.1 for servicing frequency.

6.3 Store the rebar lanyard in a cool, dry, clean environment, out of direct sunlight. Avoid areas where chemical vapors are present. Thoroughly inspect this equipment after extended storage.

7.0 SPECIFICATIONS

7.1 MATERIALS:

Snap Hooks, Carabiners, D-rings, Swivel, Quick-link, O-ring: Steel alloy, plated. 2007153 snap hook: Aluminum alloy.

Webbing: Polyester.

Chain: Steel alloy, 5/0 twist link, zinc plated.

7.2 STRENGTH AND CAPACITY:

Snap Hooks, Carabiners, D-rings, O-ring,: 5,000 lbs. tensile strength, 310 lbs. capacity.

Webbing: 9,800 lbs. tensile strength, 310 lbs. capacity.

7.3 Review the product labels to determine if your product meets ANSI Z359.3, ANSI A10.32 and OSHA requirements. See section 9 Labels.

8.0 TERMINOLOGY

AUTHORIZED PERSON: A person assigned by the employer to perform duties at a location where the person will be exposed to a fall hazard (otherwise referred to as "user" for the purpose of these instructions).

RESCUER: Person or persons other than the rescue subject acting to perform an assisted rescue by operation of a rescue system.

CERTIFIED ANCHORAGE: An anchorage for fall arrest, positioning, restraint, or rescue systems that a qualified person certifies to be capable of supporting the potential fall forces that could be encountered during a fall or that meet the criteria for a certified anchorage prescribed in this standard.

QUALIFIED PERSON: A person with a recognized degree or professional certificate and with extensive knowledge, training, and experience in the fall protection and rescue field who is capable of designing, analyzing, evaluating and specifying fall protection and rescue systems to the extent required by this standard.

COMPETENT PERSON: One who is capable of identifying existing and predictable hazards in the surroundings or working conditions which are unsanitary, hazardous, or dangerous to employees, and who has authorization to take prompt corrective measures to eliminate them.

9.0 LABELING

9.1 The following labels must be present and fully legible:

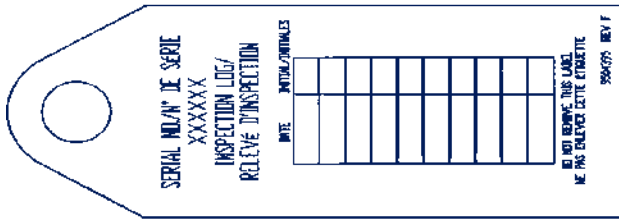
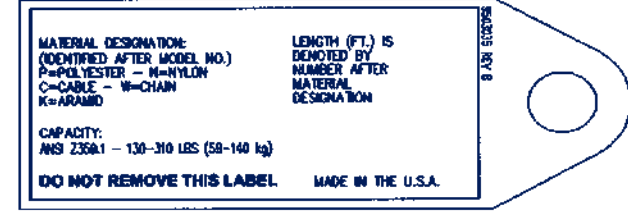
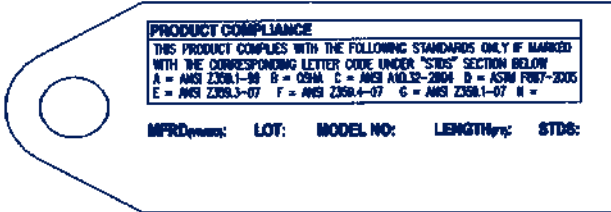
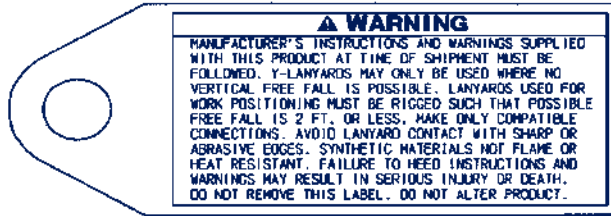

10.0 INSPECTION AND MAINTENANCE LOG

DATE OF MANUFACTURE _____

MODEL NUMBER _____

INSPECTION DATE	INSPECTION ITEMS NOTED	CORRECTIVE ACTION	MAINTENANCE PERFORMED
Approved by:			
Approved by:			
Approved by:			
Approved by:			
Approved by:			
Approved by:			
Approved by:			
Approved by:			
Approved by:			
Approved by:			
Approved by:			

This instruction applies to the following models:

1106150	1231380	5900050	5900093	5920070
1106151	1231381	5900051	5900094	5920075
1106152	1231382	5900052	5900100	5920080
1107052	1231383	5900053	5900101	5920081
1201380	1231385	5900054	5900140	5920085
1201381	1231386	5900055	5920030	5920086
1201382	1231387	5900056	5920031	5920090
1201383	1231520	5900060	5920040	5920091
1201385	1231521	5900070	5920041	5920092
1201386	1231522	5900075	5920050	5920093
1201387	1231523	5900080	5920051	5920094
1201520	1231530	5900081	5920052	5920100
1201521	1231531	5900085	5920053	5920101
1201522	5900030	5900086	5920054	5920140
1201523	5900031	5900090	5920055	1201524C
1201530	5900040	5900091	5920056	
1201531	5900041	5900092	5920060	

Additional model numbers may appear on the next printing of these instructions



A Capital Safety Company

USA

3833 SALA Way
Red Wing, MN 55066-5005
Toll Free: 800-328-6146
Phone: (651) 388-8282
Fax: (651) 388-5065
email: Solutions@CapitalSafety.com
www.capitalsafety.com

Canada

260 Export Boulevard
Mississauga, Ontario L5S 1Y9
Toll Free: 800-387-7484
Phone: (905) 795-9333
Fax: (905) 795-8777
email: Solutions@CapitalSafety.com
www.capitalsafety.com

This manual is available for download at www.capitalsafety.com.



Certificate No. FM 39709

Form: 5902358
Rev: B