



**Instructions for the
following series products:**
Full Body Harnesses

(See back pages for specific
model numbers.)

**USER INSTRUCTION MANUAL
FULL BODY HARNESS**

This manual is intended to meet the Manufacturer's Instructions as required by ANSIZ359 and CSA 259.10 and should be used as part of an employee training program as required by OSHA



Figure 1 - Delta Vest™ Full Body Harness



Figure 2 - Vest Style Full Body Harness



Figure 3 - Cross-over Style Full Body Harness



Figure 4 - Step-in Style Full Body Harness

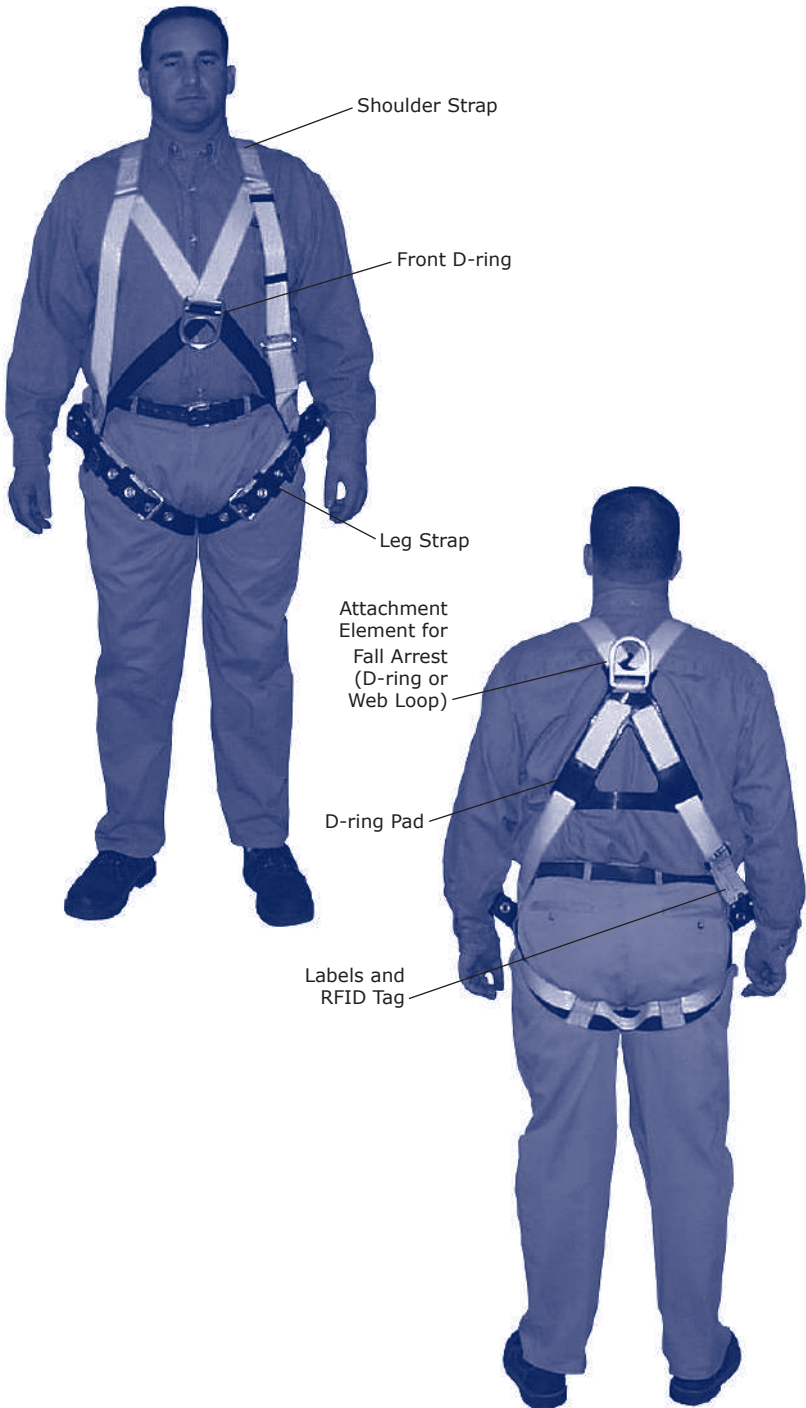

WARNING: *This product is part of a personal fall arrest, restraint, work positioning, personnel riding, climbing, or rescue system. The user must follow the manufacturer's instructions for each component of the system. These instructions must be provided to the user of this equipment. The user must read and understand these instructions before using this equipment. Manufacturer's instructions must be followed for proper use and maintenance of this equipment. Alterations or misuse of this product or failure to follow instructions may result in serious injury or death.*

IMPORTANT: *If you have questions on the use, care, or suitability of this equipment for your application, contact DBI-SALA.*

IMPORTANT: *Before using this equipment, record the product identification information from the ID label in the inspection and maintenance log in section 9.0 of this manual.*

DESCRIPTIONS

Delta Vest™ Full Body Harness: See Figure 1.

Vest Style Full Body Harness: See Figure 2.

Cross-Over Style Full Body Harness: See Figure 3.

Step-In Style Full Body Harness: See Figure 4.

OPTIONS:

DBI-SALA Full Body Harnesses are available with options and accessories. Following is a partial list of commonly used options and accessories (some options may not be available on all harnesses):

- Shoulder D-rings
- Side D-rings
- Hip pad with side D-rings
- Quick Connect buckles
- Tongue buckle body belt
- Loops on harness for body belt
- Kevlar® webbing
- High visibility webbing
- Non-sparking/Non conductive PVC coated hardware
- Shoulder pads
- Tool belt support straps
- Seat sling
- Lanyard attached directly to D-ring or attachment element
- Snap fastener on shoulder strap for retaining lanyard
- Delta Vest™
- Tool holders

1.0 APPLICATIONS

1.1 PURPOSE: DBI-SALA full body harnesses are to be used as components in personal fall arrest, restraint, work positioning, or rescue systems. See Figures 1, 2, 3, and 4 for harness styles.

Harnesses included in this manual are full body harnesses and meet ANSI Z359.1, OSHA, and CSA Z259.10 requirements. See Figure 5 for application illustrations.

- Full body harnesses with Kevlar web should be used when working with tools, materials, or environments of high temperature (foundries, chemical manufacturing, steel fabrication, emergency rescue services, fire services, welders, oil industry, nuclear industry, explosives).
- Harnesses with PVC coated hardware should be used when working in explosive or electrically conductive environments, or where surfaces must be protected from the hardware.
- Harnesses with high visibility webbing should be used when increased visibility of the user is required.

A. PERSONAL FALL ARREST: The full body harness is used as a component of a personal fall arrest system. Personal fall arrest systems typically include a full body harness and a connecting subsystem (energy absorbing lanyard). Maximum arresting force must not exceed 1,800 lbs (8 kN). For fall protection applications connect the fall arrest subsystem (example: lanyard, SRL, energy absorber, etc.) to the D-ring or attachment element on your back, between your shoulder blades.



B. WORK POSITIONING: The full body harness is used as a component of a work positioning system to support the user at a work position. Work positioning systems typically include a full body harness, positioning lanyard, and a back-up personal fall arrest system. For work positioning applications, connect the work positioning subsystem (example: lanyard, Y-lanyard, etc.) to the lower (hip level) side or belt mounted work positioning attachment anchorage elements (D-rings). Never use these connection points for fall arrest.



Figure 5 - Applications

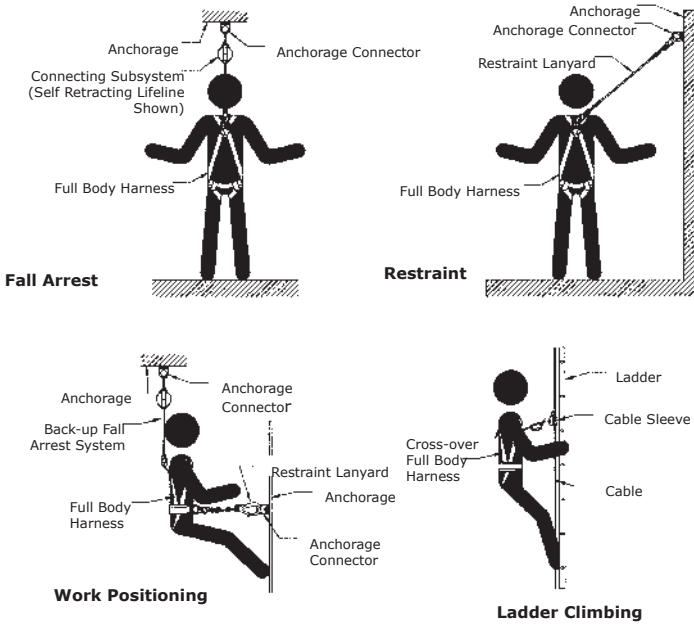

C. LADDER CLIMBING: The full body harness is used as a component of a climbing system to prevent the user from falling when climbing a ladder or other climbing structure. Climbing systems typically include a full body harness, vertical cable or rail attached to the structure, and climbing sleeve. For ladder climbing applications, harnesses equipped with a frontal D-ring in the sternal location may be used for fall arrest on fixed ladder climbing systems. These are defined in Z259.2.1 in Canada and ANSI A14.3 in the United States.



D. RESCUE: The full body harness is used as a component of a rescue system. Rescue systems are configured depending on the type of rescue. For limited access (confined space) applications, harnesses equipped with D-rings on the shoulders may be used for entry and egress into confined spaces where worker profile is an issue.



- E. CONTROLLED DESCENT:** For controlled descent applications, harnesses equipped with a single sternal level D-ring, one or two frontal mounted D-rings, or a pair of connectors originating below the waist (such as a seat sling) may be used for connection to a descender or evacuation system (reference in Z259.10 in Canada).



- F. RESTRAINT:** The full body harness is used as a component of a restraint system to prevent the user from reaching a fall hazard. Restraint systems typically include a full body harness and a lanyard or restraint line.

1.2 LIMITATIONS: Consider the following application limitations before using this equipment:

- A. CAPACITY:** These full body harnesses are designed for use by persons with a combined weight (clothing, tools, etc.) of no more than 420 lbs. Make sure all of the components in your system are rated to a capacity appropriate to your application
- B. FREE FALL:** Personal fall arrest systems used with this equipment must be rigged to limit the free fall to 6 feet (1.8 M) (ANSI Z359.1). Restraint systems must be rigged so that no vertical free fall is possible. Work positioning systems must be rigged so that free fall is limited to 2 feet (.6 m) or less. Personnel riding systems must be rigged so that no vertical free fall is possible. Climbing systems must be rigged so that free fall is limited to 18 in. (.46 m) or less. Rescue systems must be rigged so that no vertical free fall is possible. See subsystem manufacturer's instructions for more information.
- C. FALL CLEARANCE:** See Figure 6. There must be sufficient clearance below the user to arrest a fall before the user strikes the ground or other obstruction. The clearance required is dependent on the following factors:
- Elevation of anchorage
 - Connecting subsystem length
 - Deceleration distance
 - Free fall distance
 - Worker height
 - Movement of harness attachment element

See subsystem manufacturer's instructions for more information.

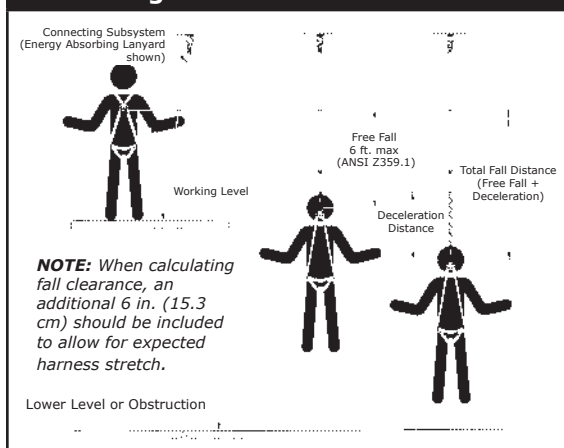
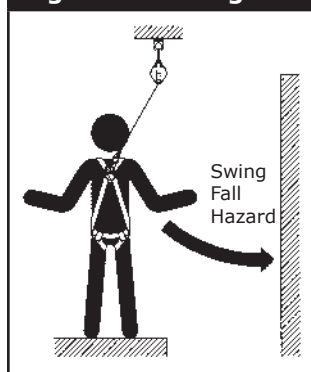
Figure 6 - Fall Clearance**Figure 7 - Swing Fall**

- D. SWING FALLS:** See Figure 7. Swing falls occur when the anchorage point is not directly above the point where a fall occurs. The force of striking an object in a swing fall may cause serious injury or death. Minimize swing falls by working as close to the anchorage point as possible. Do not permit a swing fall if injury could occur. Swing falls will significantly increase the clearance required when a self-retracting lifeline or other variable length connecting subsystem is used.
- E. EXTENDED SUSPENSION:** A full body harness is not intended for use in extended suspension applications. If the user is going to be suspended for an extended length of time it is recommended that some form of seat support be used. DBI-SALA recommends a seat board, suspension workseat, seat sling, or a boatswain chair. Contact DBI-SALA for more information on these items.
- F. ENVIRONMENTAL HAZARDS:** Use of this equipment in areas with environmental hazards may require additional precautions to prevent injury to the user or damage to the equipment. Hazards may include, but are not limited to; heat, chemicals, corrosive environments, high voltage power lines, gases, moving machinery, and sharp edges.
- G. HARNESES FOR HIGH TEMPERATURE ENVIRONMENTS:** Harnesses with Kevlar webbing are designed for use in high temperature environments, with limitations: Kevlar webbing begins to char at 800° to 900° Fahrenheit. Kevlar webbing can withstand limited contact exposure to temperatures up to 1,000° F. Polyester webbing loses strength at 300° to 400° F. PVC coating on hardware has a melting point of approximately 350° F.

IMPORTANT: *When working with tools, materials, or in high temperature environments, ensure that associated fall protection equipment can withstand high temperatures, or provide protection for those items.*

IMPORTANT: *Although PVC coated, cadmium, or zinc plated hardware exhibit excellent corrosion resistance in chemical, acidic, alkaline, and atmospheric conditions, frequent inspections may be required. Consult with DBI-SALA if you question the use of this equipment in hazardous environments.*

H. TRAINING: This equipment must be installed and used by persons trained in its correct application and use. See section 4.0.

1.3 APPLICABLE STANDARDS: Refer to national standards, including ANSI Z359 (.0, .1, .2, .3, and .4) family of standards on fall protection, ANSI A10.32, CSA Z259.10, and applicable local, state and federal (OSHA) requirements governing occupational safety for more information about work positioning systems.

IMPORTANT: *Harnesses with Kevlar webbing do not meet ANSI Z359.1. Kevlar does not have equivalent abrasion resistance of polyamides. Kevlar harnesses meet all other requirements of this standard.*

2.0 SYSTEM REQUIREMENTS

2.1 COMPATIBILITY OF COMPONENTS: DBI-SALA equipment is designed for use with DBI-SALA approved components and subsystems only. Substitutions or replacements made with non-approved components or subsystems may jeopardize compatibility of equipment and may effect the safety and reliability of the complete system.

2.2 COMPATIBILITY OF CONNECTORS: Connectors are considered to be compatible with connecting elements when they have been designed to work together in such a way that their sizes and shapes do not cause their gate mechanisms to inadvertently open regardless of how they become oriented. Contact DBI-SALA if you have any questions about compatibility.

Connectors (hooks, carabiners, and D-rings) must be capable of supporting at least 5,000 lbs. (22.2 kN). Connectors must be compatible with the anchorage or other system components. Do not use equipment that is not compatible. Non-compatible connectors may unintentionally disengage. See Figure 8. Connectors must be compatible in size, shape, and strength. Self-locking snap hooks and carabiners are required by ANSI Z359.1 and OSHA.

2.3 MAKING CONNECTIONS: Use only self-locking snap hooks and carabiners with this equipment. Use only connectors that are suitable to each application. Ensure all connections are compatible in size, shape and strength. Do not use equipment that is not compatible. Ensure all connectors are fully closed and locked.

DBI-SALA connectors (snap hooks and carabiners) are designed to be used only as specified in each product's user's instructions. See Figure 9 for inappropriate connections. DBI-SALA snap hooks and carabiners should not be connected:

- A. To a D-ring to which another connector is attached.
- B. In a manner that would result in a load on the gate.

Figure 8 - Unintentional Disengagement (Rollout)

If the connecting element to which a snap hook (shown) or carabiner attaches is undersized or irregular in shape, a situation could occur where the connecting element applies a force to the gate of the snap hook or carabiner. This force may cause the gate (of either a self-locking or a non-locking snap hook) to open, allowing the snap hook or carabiner to disengage from the connecting point.

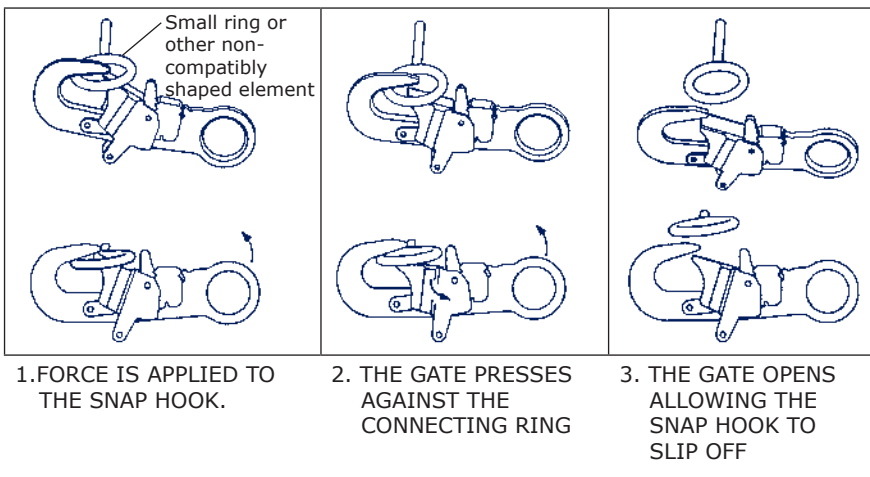

NOTE: Large throat snap hooks should not be connected to standard size D-rings or similar objects which will result in a load on the gate if the hook or D-ring twists or rotates, unless the snap hook complies with ANSI Z359.1-2007 and is equipped with a 3,600 lb gate. Check the marking on your snap hook to verify that it is appropriate for your application.

- C. In a false engagement, where features that protrude from the snap hook or carabiner catch on the anchor, and without visual confirmation seems to be fully engaged to the anchor point.

Figure 9 - Inappropriate Connections

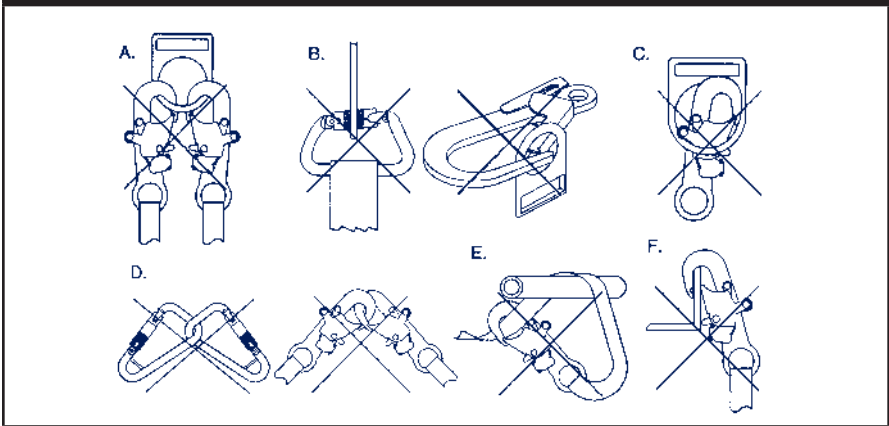

- D. To each other.
- E. Directly to webbing or rope lanyard or tie-back (unless the manufacturer's instructions for both the lanyard and connector specifically allows such a connection).
- F. To any object which is shaped or dimensioned such that the snap hook or carabiner will not close and lock, or that roll-out could occur.

2.4 CONNECTING SUBSYSTEMS: Connecting subsystems (self-retracting lifeline, lanyard, rope grab and lifeline, cable sleeve) must be suitable for your application. See section 1.1. See subsystem manufacturer's instructions for more information. Some harness models have web loop connection points. Do not use snap hooks to connect to web loops. Use a self-locking carabiner to connect to a web loop. Ensure the carabiner cannot cross-gate load (load against the gate rather than along the backbone of the carabiner). Some lanyards are designed to choke onto a web loop to provide a compatible connection. See Figure 10. Lanyards may be sewn directly to the web loop forming a permanent connection. Do not make multiple connections onto one web loop, unless choking two lanyards onto a properly sized web loop.

2.5 ANCHORAGE STRENGTH: The anchorage strength required is dependent on the application type. The following are the requirements of ANSI 359.1 for these application types:

- A. **FALL ARREST:** Anchorages selected for fall arrest systems shall have a strength capable of sustaining static loads applied in the directions permitted by the system of at least:
 1. 5,000 lbs. (22.2 kN) for non-certified anchorages, or
 2. Two times the maximum arresting force for certified anchorages. When more than one fall arrest system is

attached to an anchorage, the strengths set forth in (1) and (2) above shall be multiplied by the number of systems attached to the anchorage.

B. RESTRAINT:

Anchages selected for restraint and travel restraint systems shall have a strength capable of sustaining static loads applied in the

directions permitted by the system of at least:

1. 1,000 lbs. (4.5 kN) for non-certified anchorages, or
 2. Two times the foreseeable force for certified anchorages.
- When more than one restraint and travel restraint system is attached to an anchorage, the strengths set forth in (1) and (2) above shall be multiplied by the number of systems attached to the anchorage.

C. WORKING POSITIONING: Anchorages selected for work positioning systems shall have a strength capable of sustaining static loads applied in the directions permitted by the system of at least:

1. 3,000 lbs. (13.3 kN) for non-certified anchorages, or
2. Two times the foreseeable force for certified anchorages. When more than one work positioning system is attached to an anchorage, the strengths set forth in (1) and (2) above shall be multiplied by the number of systems attached to the anchorage.

D. RESCUE: Anchorages selected for rescue systems shall have a strength capable of sustaining static loads applied in the directions permitted by the system of at least:

1. 3,000 lbs. (13.3 kN) for non-certified anchorages, or
2. Five times the foreseeable force for certified anchorages. When more than one rescue system is attached to an anchorage, the strengths set forth in (1) and (2) above shall be multiplied by the number of systems attached to the anchorage.

E. CLIMBING: The structure to which a climbing system is attached must sustain the loads required by that particular system. See instructions for climbing system for requirements.

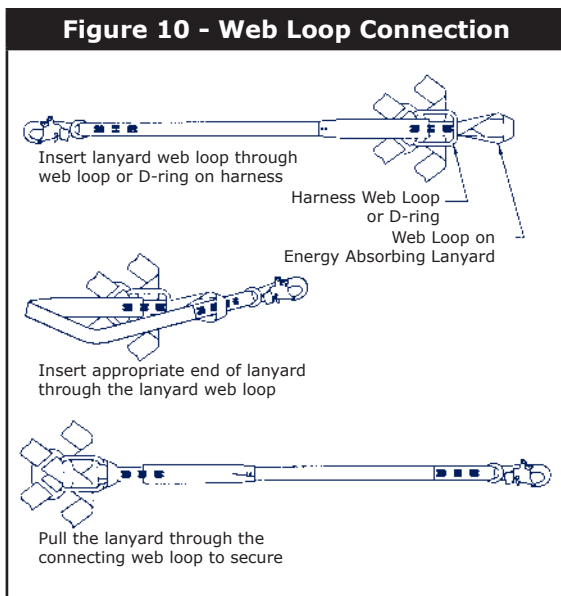

3.0 DONNING AND USE

WARNING: Do not alter or intentionally misuse this equipment. Consult DBI-SALA when using this equipment in combination with components or subsystems other than those described in this manual. Some subsystem and component combinations may interfere with the operation of this equipment. Use caution when using this equipment around moving machinery, electrical and chemical hazards, and sharp edges.

WARNING: Consult your doctor if there is reason to doubt your fitness to safely absorb the shock from a fall arrest. Age and fitness seriously affect a worker's ability to withstand falls. Pregnant women or minors must not use any DBI-SALA full body harness.

- 3.1 BEFORE EACH USE** of this equipment inspect it according to section 5.0 of this manual.
- 3.2 PLAN** your system before use. Consider all factors that will affect your safety during use of this equipment. The following list gives important points to consider when planning your system:
- A. ANCHORAGE:** Select an anchorage that meets the requirements specified in sections 1.2 and 2.5.
 - B. SHARP EDGES:** Avoid working where system components may be in contact with, or abrade against, unprotected sharp edges.
 - C. AFTER A FALL:** Components which have been subjected to the forces of arresting a fall must be removed from service and destroyed.
 - D. RESCUE:** The employer must have a rescue plan when using this equipment. The employer must have the ability to perform a rescue quickly and safely.

3.3 DONNING AND FITTING THE HARNESS:

- A. DELTA VEST™ HARNESS:** See Figure 11 for front and back views of the Delta Vest™ harness. Don the Delta Vest™ full body harness by following these steps (see Figures 12 and 13).

Figure 11 - Front and Back View of Delta Vest™ Harness

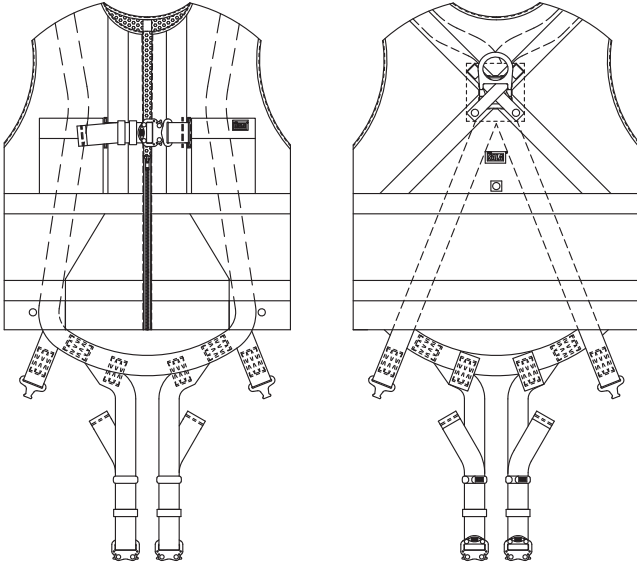

- Step 1.** Lift harness by the back D-ring and untangle straps. Allow leg straps to hang free.
- Step 2.** Don the Vest Harness as you would a jacket. Do not zip the vest at this time.
- Step 3.** Connect chest strap by passing male buckle through female buckle. Pass excess webbing through loop keepers. See Figure 13.
- Step 4.** Reach between legs and grasp blue leg strap on your left side. Bring strap up between legs and connect to buckle attached to yellow strap (orange on high visibility models, black on flame resistant models) as shown in Figures 12 and 13. Connect right leg strap.
- Step 5.** Reach inside the vest and adjust shoulder straps to a snug fit. Left and right shoulder straps should be adjusted to the same length. Readjust leg straps, chest strap, and shoulder straps as necessary to a snug fit.
- Step 6.** Zip the vest.

Figure 12 - Donning the Delta Vest™ Harness

Delta Vest™ Harness



Step 1



Step 2



Step 3



Step 4



Step 5



Step 6

Figure 13 - Delta Vest™ Harness Buckle Connections



Chest Strap: Pass male buckle through female buckle and pull free end of webbing to tighten.



Tongue Buckle: Pass webbing through buckle and insert tongue through grommet.



Parachute Buckle: Pass webbing under buckle and over roller and down between roller and frame. Pull web end to tighten. Three inches of web must extend past buckle.



Pass Buckle: Pass male buckle through female buckle and pull free end of webbing to tighten.

B. VEST STYLE

HARNES: If your harness incorporates loops for a removable waist belt, the belt should be installed through the four loops in the harness as shown in Figure 14. The hip pad, if used, is secured to the belt by passing the belt through the hip pad loops. Don the vest style full body harness by following these steps (see Figures 15 and 16):

Figure 14 - Removable Waist Belt & Hip Pad

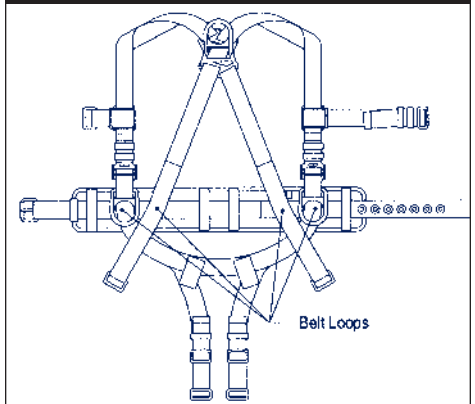

- Step 1.** Locate back D-ring held in position by the D-ring pad; lift up harness and hold by this D-ring. Ensure the straps are not twisted.
- Step 2.** Grasp the shoulder straps and slip harness onto one arm. D-ring will be located on your back side. Ensure

Figure 15 - Donning Vest Style Harness



Step 1



Step 2



Step 3



Step 4



Step 5

Figure 16 - Vest Style Harness Buckle Connections



Chest Strap: Pass male buckle through female buckle and pull free end of webbing to tighten.



Chest Strap: Attach chest strap by inserting the tab of the buckle into the receptor of the quick connect buckle until a click is heard.



Parachute Buckle: Pass webbing under buckle and over roller and down between roller and frame. Pull web end to tighten. Three inches of web must extend past buckle.



Tongue Buckle: Pass webbing through buckle and insert tongue through grommet.



Pass Buckle: Pass male buckle through female buckle and pull free end of webbing to tighten.



Quick Connect Buckle: Insert the tab of the buckle into the receptor of the quick connect buckle until a click is heard.

straps are not tangled and hang freely. Slip free arm into harness and position shoulder straps on top of shoulder. Ensure straps are not tangled and hang freely. Chest strap with pass through buckle will be positioned on front side when worn properly.

- Step 3.** Reach between your legs and grasp the leg strap on your left side. Bring the strap up between your legs and connect it by inserting the tab of the buckle into the receptor of quick connect buckle on the left side as shown in Figure 1. You will hear a click when the tab engages properly. Pull the free end of the strap away

from the buckle to make a snug fit on each leg strap. To loosen the leg strap, grasp the yellow plastic portion of the buckle and pull away from your leg to allow the strap to pull through the buckle. A plastic end keeper on the end of the strap will stop it from pulling completely out of the buckle. To release the buckle, press the silver-colored tabs on the buckle towards each other with one hand, while pulling on the tab portion to the buckle with the other hand. Repeat this procedure for the right side.

Step 4. Attach the chest strap by inserting the tab of the buckle into receptor of quick connect buckle. See Figure 1. You will hear a click when the tab engages properly. Chest strap should be six inches down from the top of shoulders. Pass excess strap through the loop keepers. The strap may be tightened to a snug fit by pulling the free strap end to the left (away from the buckle). To loosen the chest strap, grasp the yellow plastic portion of the buckle and pull away from the body to allow the strap to pull through the buckle. A plastic end keeper on the end of the strap will stop it from pulling completely out of the buckle. To release the buckle, press the silver-colored tabs on the buckle towards each other with one hand, while pulling on the tab portion to the buckle with the other hand.

Step 5. Adjust shoulder straps to a snug fit by pulling excess strap through the parachute buckles on each side of the harness. Left and right sides of shoulder straps should be adjusted to the same length and the chest strap should be centered on your lower chest, six inches down from shoulder. The front D-ring on vest style harness is moved up or down by adjusting the shoulder straps and leg straps. Center the back D-ring between shoulder blades. Adjust leg straps to a snug fit. At least three inches of webbing must extend past buckle on leg straps. Adjust the waist belt (if present).

C. CROSS-OVER STYLE HARNESS: If your harness incorporates loops for a removable waist belt, the belt

Figure 17 - Removable Waist Belt and Hip Pad

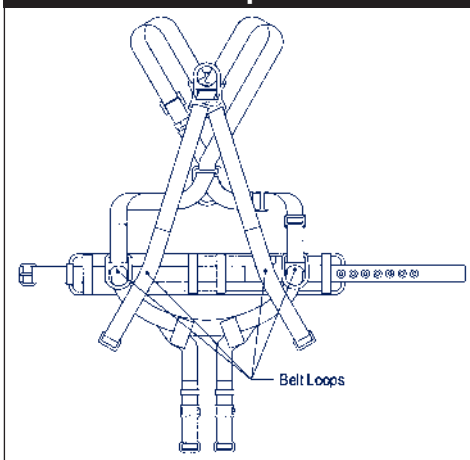

Figure 18 - Donning Cross-over Style Harness



Step 1



Step 2



Step 3



Step 4



Step 5

should be installed through the four loops in the harness as shown in Figure 17. The hip pad, if used, is secured to the belt by passing the belt through the hip pad loops. Don the cross-over style full body harness by following these steps (see Figures 18 and 19):

- Step 1.** Locate back D-ring held in position by the D-ring pad; lift up harness and hold by this D-ring. Ensure the straps are not twisted.
- Step 2.** Grasp shoulder straps between back and front D-ring and slip harness over your head from the left side. Position shoulder straps on top of shoulder. Ensure straps are not tangled and hang freely. The D-ring will be positioned on your back when worn properly.
- Step 3.** Grasp male pass-through buckle located on yellow strap (orange on high visibility models, black on flame resistant models) below front D-ring and connect to female pass-through buckle (attached to blue or strap on right hip). Male end of buckle must pass through female end. Ensure straps are not tangled or crossed.
- Step 4.** Reach between legs and grasp blue leg strap on your

Figure 19 - Cross-over Style Harness Buckle Connections



Tongue Buckle: Pass webbing through buckle and insert tongue through grommet.



Pass Buckle: Pass male buckle through female buckle and pull end of webbing to tighten.



Quick Connect Buckle: Insert the tab of the buckle into the receptor of the quick connect buckle until a click is heard



Parachute Buckle: Pass webbing under buckle and over roller and down between roller and frame. Pull web end to tighten. Three inches of web must extend past buckle.

left side. Bring strap up between legs and connect to buckle attached to yellow strap (orange on high visibility models, black on flame resistant models). Connect right leg strap.

Step 5. Adjust shoulder straps to a snug fit. Left and right sides of shoulder straps should be adjusted to the same length and the front D-ring should be centered on your lower chest. The back D-ring should be centered between your shoulder blades. Adjust leg straps to a snug fit. At least three inches of webbing must extend past parachute adjuster buckle when used on leg straps. Adjust the waist belt (if present). Center retrieval D-rings (if present) on top of each shoulder.

D. STEP-IN STYLE HARNESS: Don the step-in style full body harness by following these steps (see Figures 20 and 21):

Step 1. Locate back D-ring held in position by the D-ring pad; lift up harness and hold by this D-ring. Ensure the straps are not twisted.

Step 2. Step into harness by placing right leg over the seat sling and then your left leg.

Step 3. Raise harness up and slip arms between front and back shoulder straps. Slip the back D-ring pad over your head with your head between the front shoulder straps and the adjuster links.

Step 4. Reach between legs and grasp blue leg strap on your left side. Bring strap up between legs and connect to buckle attached to yellow strap (orange on high visibility models, black on flame resistant models). Connect right leg strap.

Step 5. Tighten shoulder straps through adjuster links and front D-ring. Adjustment slack should be given out or taken up through the buckle on the lower left shoulder strap. Left and right shoulder straps should be adjusted to the same length, and the front D-ring should be centered on your lower chest. The back D-ring should be centered between your shoulder blades. Adjust leg straps to a snug fit.

3.4 USE OF FALL ARREST D-RING OR ATTACHMENT ELEMENT:

For fall protection applications connect to the D-ring or attachment element on your back, between your shoulder blades. Side D-rings, if present, are for positioning or restraint applications only. Shoulder retrieval D-rings are for rescue or retrieval applications only. Front D-ring is for ladder climbing or positioning. D-rings on seat sling are for suspension or positioning applications only.

Figure 20 - Donning Step-in Style Harness



Step 1



Step 2



Step 3



Step 4



Step 5

Figure 21 - Step-in Style Harness Buckle Connections



Tongue Buckle: Pass webbing through buckle and insert tongue through grommet.



Pass Buckle: Pass male buckle through female buckle and pull free end of webbing to tighten.



Parachute Buckle: Pass webbing under buckle and over roller and down between roller and frame. Pull web end to tighten. Three inches of web must extend past buckle.

3.5 MAKING CONNECTIONS: When using a hook to connect to an anchorage or when coupling components of the system together, ensure roll-out cannot occur. Roll-out occurs when interference between the hook and mating connector causes the hook gate to unintentionally open and release. Self-locking snap hooks and carabiners should be used to reduce the possibility of roll-out. Do not use hooks or connectors that will not completely close over the attachment object. See subsystem manufacturer's instructions for more information on making connections.

3.6 CONNECTING SYSTEM COMPONENTS: After fitting the full body harness the user may then connect to other system components. Follow the guidelines in section 3.4 on selecting the correct attachment element.

4.0 TRAINING

4.1 It is the responsibility of the user and the purchaser of this equipment to assure that they are familiar with these instructions, trained in the correct care and use of, and are aware of the operating characteristics, application limits, and the consequences of improper use of this equipment.

IMPORTANT: Training must be conducted without exposing the user to a fall hazard. Training should be repeated on a periodic basis.

5.0 INSPECTION

5.1 The i-Safe™ RFID tag on this harness can be used in conjunction with the i-Safe handheld reading device and the web based portal to simplify inspection and inventory control and provide records for your fall protection equipment See Figure 22.

5.2 FREQUENCY: Before each use inspect the full body harness according to sections 5.3 and 5.4. The harness must be inspected by a competent person, other than the user, at least annually. Record the results of each formal inspection in the inspection and maintenance log in section 9.0, or use the i-Safe™ inspection web portal to maintain your inspection records. If you are a first-time user, contact a Customer Service representative in the US at 800-328-6146 or in Canada at 800-387-7484 or if you have already registered, go to: www.capitalsafety.com/isafe.html. Follow instructions provided with your i-Safe handheld reader or on the web portal to transfer your data to your web log.

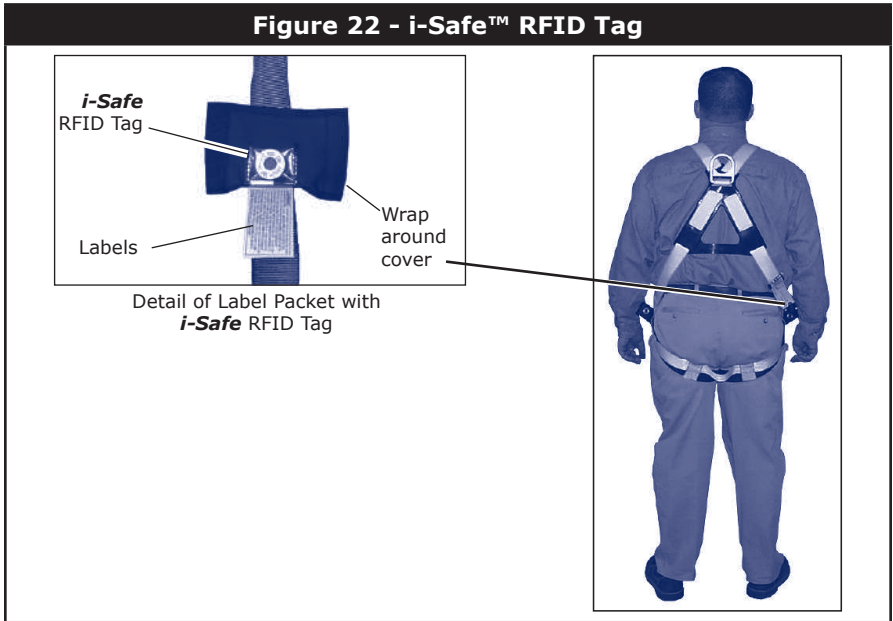

IMPORTANT: If the full body harness has been subjected to fall arrest or impact forces it must be immediately removed from service and destroyed.

IMPORTANT: Extreme working conditions (harsh environments, prolonged use, etc.) may require increasing the frequency of inspections.

5.3 INSPECTION STEPS:

Step 1. Inspect harness hardware (buckles, D-rings, back pad, loop keepers); These items must not be damaged, broken, distorted, and must be free of sharp edges, burrs, cracks, worn parts, or corrosion. PVC coated hardware must be free of cuts, rips, tears, holes, etc. in the coating to ensure non-conductivity. Ensure buckles work smoothly. If present, inspect the quick connect buckles by ensuring that the release tabs work freely and that a click is heard when the buckle engages. Inspect parachute buckle spring.

Step 2. Inspect webbing; material must be free of frayed, cut, or broken fibers. Check for tears, abrasions, mold, burns, or discoloration. Inspect stitching; Check for pulled or cut stitches. Broken stitches may be an indication that the harness has been impact loaded and must be removed from service.

IMPORTANT: *On Delta Vest™ harnesses, inspection should include the webbing inside the vest.*

Step 3. Inspect labels; All labels should be present and fully legible. See section 8.0.

Step 4. Inspect each system component or subsystem according to manufacturer's instructions.

Step 5. Impact Indicators: Fall arrest impact indicators give a permanent, readily visible warning if the harness has arrested a fall (or has been subjected to an equivalent force). Impact indicators must be inspected before each use. If the impact indicator has been activated the harness must be removed from service and destroyed. Each harness includes one of the following built-in fall arrest impact indicators:

Stitched impact indicator: The stitched impact indicator is a section of webbing that is lapped back on itself and secured with a specific stitch pattern holding the lap. The stitch pattern is designed to release when the harness arrests a fall or has been subjected to an equivalent force.

Dorsal D-ring impact indicator: The dorsal D-ring indicator (Figure 23) consists of a D-ring which is fitted into a plastic housing. This is designed so that the D-ring will be released from the housing exposing a red impact indication label when the harness arrests a fall or has been subjected to an equivalent force.

Figure 23 - Impact Indicator

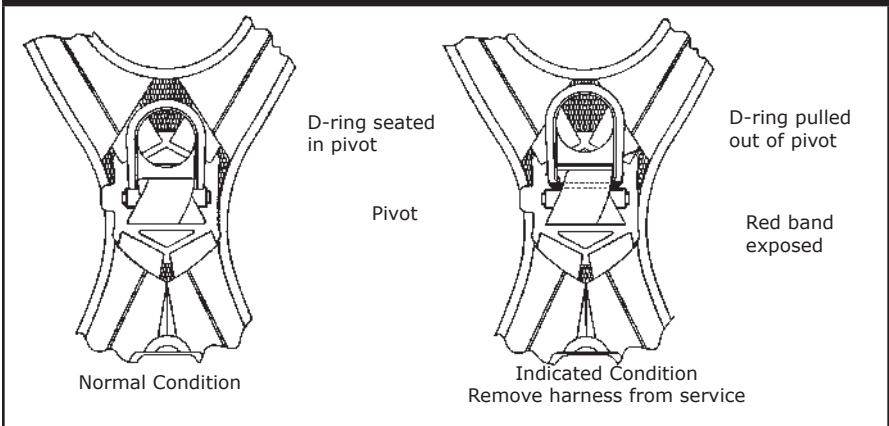

Step 6. Record the inspection date and results in the inspection and maintenance log in section 9.0, or use the i-Safe™ inspection web portal.

NOTE: Some harnesses are equipped with a “stand up D-ring” in the dorsal (back) D-ring location. If the spring in the D-ring is damaged or lost and the D-ring no longer stands up, this does not compromise the harness integrity. As long as the D-ring passes inspection criteria in Step 1, it is safe to use.

5.4 If inspection reveals a defective condition, remove unit from service immediately and destroy.

NOTE: Only DBI-SALA or parties authorized in writing may make repairs to this equipment.

5.5 PRODUCT LIFE: The functional life of DBI-SALA harnesses is determined by work conditions and maintenance. As long as the product passes inspection criteria, it may remain in service.

6.0 MAINTENANCE, SERVICING, STORAGE

6.1 WASHING INSTRUCTIONS:

A. FULL BODY HARNESS: Clean full body harness with water and a mild soap solution. Do not use bleach or bleach solutions. Wipe off hardware with a clean, dry cloth, and hang to air dry. Do not force dry with heat. An excessive buildup of dirt, paint, etc. may prevent the full body harness from working properly, and in severe cases degrade the webbing to a point where it weakens and should be removed from service. More information on cleaning is available from DBI-SALA. If you have questions concerning the condition of your harness, or have any doubt about putting it into service contact DBI-SALA.

B. FIRE RESISTANT PADDING:

- Remove pads from harness for laundering. Place the harness in the supplied laundry bag. The bag is designed to prevent entanglement of harness and to protect the washing machine from damage. Use of the laundry bag to wash the pads is optional.
- Launder flame resistant pads separately from harness or other non-flame resistant garments. Lint from other garments may affect flame resistance.
- Use a bleach-free detergent when washing both the harness and the pads. Do not use soap; soap may leave a residue which could affect flame resistance.
- Do not use chlorine bleach. Bleach may weaken fabric and reduce product life.
- Oily or greasy stains may be pre-treated and washed in hot water 140°F max (60°C max).
- Use delicate, permanent press, or cotton sturdy wash cycle with cold or warm water. Hot water can be used on heavily soiled items as long as it does not exceed 140°F (60°C). Use extra rinse cycle to be sure all residual wash chemicals are removed.
- Air dry or tumble dry using permanent press cycle and low heat. Drying temp should not exceed 200°F (93°C). These fabrics dry quickly, for lowest shrinkage, do not over dry.

6.2 Additional maintenance and servicing procedures must be completed by a factory authorized service center. Authorization must be in writing. Do not attempt to disassemble the unit.

6.3 Store full body harnesses in a cool, dry, clean environment out of direct sunlight. Avoid areas where chemical vapors may exist. Thoroughly inspect the full body harness after extended storage.

7.0 SPECIFICATIONS

7.1 PERFORMANCE

Maximum Free Fall Distance: No greater than 6 feet (1.8 m), per federal law and ANSI Z359.1.

Maximum Arresting Force: 1,800 lbs. (8 kN)

Capacity: 420 lbs. (191 kg)

Approximate Weight:

Harness only: 3 lbs. (1.4.kg)

Harness with Side D-rings: Add 1/2 lb. (.23 kg)

Harness with Back Pad or Belt: Add 1 lb. (.45 kg)

Cross-over Style Harness Patent numbers:

United States: 5,203,829

Canada: 2,080,643

All harnesses, excluding Kevlar harnesses, meet ANSI Z359.1 and OSHA requirements.

7.1 MATERIALS

Standards: All harnesses marked with ASTM F887-2004 meet all testing requirements of the standard.

Webbing Materials: 7000 lbs. Tensile strength Nylon
7000 lbs. Tensile strength Nomex* covered Kevlar*

Pad and Label Cover Materials:









- All outer fabric is Nomex and Kevlar blend fabric
- Fire resistant hook and loop fasteners

Optional Accessories:

- Hip Pad with side D-rings
- Nomex covered Kevlar webbing
- Non-sparking/ Non-conductive PVC coated hardware
- Arc-rated hip, leg, and back pads
- Polyurethane coated, arc-rated dorsal web loop

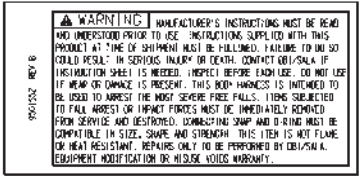
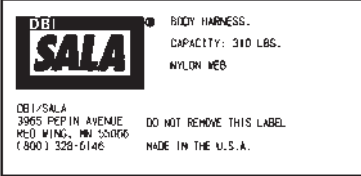
8.0 LABELING

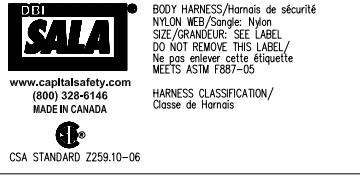
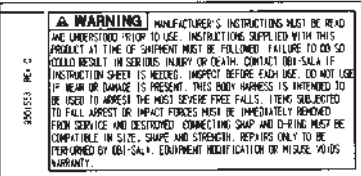
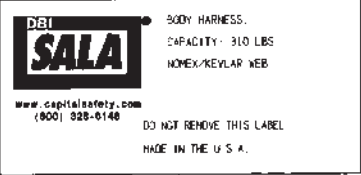
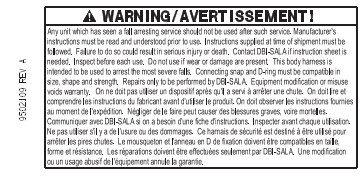
8.1 The following labels must be present and completely legible:

ANSI	CSA
 <p data-bbox="178 443 458 467">RFID Serial Number Label</p>	 <p data-bbox="686 443 845 467">Étiquette RFID</p>
 <p data-bbox="263 621 373 646">Size Label</p>	 <p data-bbox="671 621 862 646">Étiquette de taille</p>
 <p data-bbox="150 719 171 784">950210Z REV B</p>  <p data-bbox="150 963 426 1011">DBI/SALA 3965 PEPIN AVENUE MEO MING, MN 55066 (800) 328-6146 MADE IN THE U.S.A.</p> <p data-bbox="125 1044 511 1092">Warning Label Used on Nylon ASTM F887-2004 Compliant Harnesses</p>	 <p data-bbox="596 719 618 784">950210Z REV C</p>  <p data-bbox="596 946 862 979">www.capitalsafety.com (800) 328-6146 MADE IN CANADA HARNESS CLASSIFICATION/ Classe de Harnais</p> <p data-bbox="586 1011 724 1027">CSA STANDARD Z259.10-06</p> <p data-bbox="561 1044 976 1092">Étiquette de mise en garde du harnais de nylon</p>
 <p data-bbox="150 1169 171 1234">950210Z REV C</p>  <p data-bbox="150 1401 426 1450">www.capitalsafety.com (800) 328-6146 DO NOT REMOVE THIS LABEL MADE IN THE U.S.A.</p> <p data-bbox="114 1494 533 1542">Warning Label Used on Nomex/Kevlar ASTM F887-2004 Compliant Harnesses</p>	 <p data-bbox="596 1169 618 1234">950210Z REV A</p>  <p data-bbox="596 1401 820 1433">www.capitalsafety.com USA: (800) 328-6146 Canada: (800) 387-7484 MADE IN CANADA Fabriqué au Canada Harness classification: Classe de harnais: CSA STANDARD Z259.10</p> <p data-bbox="569 1494 969 1542">Étiquette de mise en garde du harnais Nomex ou Kevlar</p>

ANSI

CSA

WARNING MANUFACTURER'S INSTRUCTIONS MUST BE READ AND UNDERSTOOD PRIOR TO USE. INSTRUCTIONS SUPPLIED WITH THIS PRODUCT AT TIME OF SHIPMENT MUST BE FOLLOWED. FAILURE TO DO SO COULD RESULT IN SERIOUS INJURY OR DEATH. CONTACT DBI-SALA IF INSTRUCTION SHEET IS NEEDED. INSPECT BEFORE EACH USE. DO NOT USE IF WEAR OR DAMAGE IS PRESENT. THIS BODY HARNESS IS INTENDED TO BE USED TO ARREST THE MOST SEVERE FREE FALLS. ITEMS SUBJECT TO FALL ARREST OR IMPACT FORCES MUST BE IMMEDIATELY REMOVED FROM SERVICE AND DESTROYED. CONNECTING SNAP AND D-RING MUST BE COMPATIBLE IN SIZE, SHAPE, AND STRENGTH. THIS ITEM IS NOT FLAME OR HEAT RESISTANT. REPAIRS ONLY TO BE PERFORMED BY DBI-SALA. EQUIPMENT MODIFICATION OR MISUSE VOID'S WARRANTY.

SALA BODY HARNESS POLYESTER WEB

www.capitalsafety.com
USA: (800) 328-6146

DO NOT REMOVE LABEL.
MADE IN XXXX

WARNING
DO NOT EXCEED CAPACITY OF THIS OR OTHER SYSTEM COMPONENTS. CAPACITY IS THE COMBINED WEIGHT FOR WHICH THE COMPONENT IS DESIGNED TO BE USED. COMBINED WEIGHT INCLUDES THE USER'S BODY WEIGHT, CLOTHING, TOOLS, AND ANY OBJECTS CARRIED. CONTACT DBI-SALA FOR MORE INFORMATION.

WARNING MANUFACTURER'S INSTRUCTIONS MUST BE READ AND UNDERSTOOD PRIOR TO USE. INSTRUCTIONS SUPPLIED WITH THIS PRODUCT AT TIME OF SHIPMENT MUST BE FOLLOWED. FAILURE TO DO SO COULD RESULT IN SERIOUS INJURY OR DEATH. CONTACT CAPITAL SAFETY IF INSTRUCTION SHEET IS NEEDED. INSPECT BEFORE EACH USE. REMOVE FROM SERVICE AFTER FALL ARREST. REMOVE FROM SERVICE IF WEAR DAMAGES ARE PRESENT DURING INSPECTION. MAKE ONLY COMPATIBLE CONNECTIONS. DO NOT ALTER OR REPAIR HARNESS.

AVERTISSEMENTS LES INSTRUCTIONS DU FABRICANT DOIVENT ÊTRE LUES ET COMPRES PRÉALABLEMENT À L'UTILISATION. LES INSTRUCTIONS FOURNIES AVEC CE PRODUIT AU MOMENT DE L'ÉDITION DOIVENT ÊTRE SUIVIES. NE GLIGNEZ PAS LES RECOMMANDATIONS POUR ÉVITER DES BLESSURES GRAVES, VOSRE MORTÉLLES. CONTACTER CAPITAL SAFETY EN CAS DE BÉSONN DE NOTICE. INSPECTER AVANT CHAQUE UTILISATION. METTRE HORS SERVICE APRÈS L'ARRÊT D'UNE CHUTE. METTRE HORS SERVICE SI L'INSPECTION RÉVÈLE DES DOMMAGES DUS À L'USURE. EFFECTUER SEULEMENT DES RÉPARATIONS COMPATIBLES. NE PAS MODIFIER OU RÉPARER LE HARNAIS.

DBI-SALA BODY HARNESS/Harnais de sécurité POLYESTER WEB/Sangle polyester

www.capitalsafety.com
(800) 328-6146
MADE IN CANADA.

HARNESS CLASSIFICATION/
Closse de Harnais

CSA STANDARD Z259.10-06

Warning Label

Vignette de mise en garde

USER IDENTIFICATION/
MARK LABEL WITH PERMANENT MARKER

A - BACK D-RING IS FOR FALL ARREST AND RESCUE.

B - FRONT D-RING (IF PRESENT) IS FOR POSITIONING, LADDER CLIMBING, OR FALL ARREST (2 FT. MAXIMUM FREEFALL). USE SELF-LOCKING SNAPS ONLY.

C - SIDE D-RINGS (IF PRESENT) ARE FOR POSITIONING.

D - SHOULDER D-RINGS (IF PRESENT) ARE FOR RESCUE ONLY. DO NOT USE FOR OTHER PURPOSES. USE SELF-LOCKING SNAPS ONLY.

SEE INSTRUCTIONS FOR MORE DETAILS.

USER IDENTIFICATION/
IDENTIFICATION DE L'UTILISATEUR
MARQUEZ/MARQUEZ L'ÉTIQUETTE AVEC UN MARQUEUR PERMANENT.

1 FALL ARREST, CLASSE A, NE PAS RÉPARER/ARRÊT DES CHUTES
CLASSE (CLASSE A (ANSI Z359.1 AND Z359.2))

2 RESCUE (RESCUE ONLY)
SUPERVISION DE RESCUE OBLIGATOIRE

3 LADDER CLIMBING/ACCÈS LADDER/CLIMBAGE
CLASSE (CLASSE B (ANSI Z359.1 AND Z359.2))

4 POSITIONING
CLASSE (CLASSE C (ANSI Z359.1 AND Z359.2))

5 FALL ARREST AND RESCUE (FALL ARREST AND RESCUE)
CLASSE (CLASSE D (ANSI Z359.1 AND Z359.2))

SEE INSTRUCTIONS FOR MORE DETAILS/
VOIR LES DÉTAILS SUR LES RÉPARATIONS POUR PLUS DÉTAILS

Instruction Label (Vest Style)

Étiquette couverture

USER IDENTIFICATION/
MARK LABEL WITH PERMANENT MARKER

A - FRONT D-RING (IF PRESENT) IS FOR POSITIONING, LADDER CLIMBING, OR FALL ARREST (2 FT. MAXIMUM FREEFALL).

B - BACK D-RING IS FOR FALL ARREST AND RESCUE.

C - SIDE D-RINGS (IF PRESENT) ARE FOR POSITIONING.

SEE INSTRUCTIONS FOR MORE DETAILS.
U.S. PAT. NO. RE35,028
CAN. PAT. NO. 2080643.

USER IDENTIFICATION/
IDENTIFICATION DE L'UTILISATEUR
MARQUEZ/MARQUEZ L'ÉTIQUETTE AVEC UN MARQUEUR PERMANENT.

Instruction Label (Cross-Over Style)

ANSI

950300 Rev A

PRODUCT COMPLIANCE	
THIS PRODUCT COMPLIES WITH THE FOLLOWING STANDARDS ONLY IF MARKED WITH THE CORRESPONDING LETTER CODE UNDER "STDS" SECTION BELOW.	
A = ANSI Z359.1	B = OSHA
C = ANSI A10.32-2004	D = ASTM F887-2005
E = ANSI Z359.3	F = ANSI Z359.4

MFRD.(YR/MO): LOT: MODEL NO.: STDS:

SERIAL NO.: SEE RFID TAG IN CLEAR POUCH

INITIAL									
DATE									

INSPECTION LOG DO NOT REMOVE THIS LABEL

Inspection Label

CSA

950300 Rev A

INSPECTION LOG		RELEVÉ D'INSPECTION	
SERIAL NO./NUMÉRO DE SÉRIE: SEE RFID TAG IN CLEAR POUCH VOIR ÉTIQUETTE DE RFID DANS LA POUCE TRANSPARENTE			
DATE		INITIAL	

MFRD./LOT./FABR. LOT: (YR/MO) / (A/AMM) MODEL NO./ MODÈLE

950300 Rev A

Vignette d'inspection

950706 Rev F

Fall arrest or restraint system connecting web loop/ Boucle de raccordement de toile de système de retenue ou d'arrêt de chute

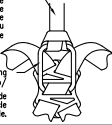

Harness, D-ring or Web Loop/ Boucle en "D" de harnais ou boucle de toile.

▲ WARNING/AVERTISSEMENT!

Only compatible connections may be made with web loops. Snap hooks (both self locking and non-locking types) connected into web loops may result in inadvertent disengagement. Refer to separate instructions for further details. Failure to follow these instructions may result in serious injury or death. Do not remove label.

Seuls des connexions compatibles doivent être faites avec les boucles de toile. Un maquetage (de type avec ou sans verrou) rattaché à une boucle de toile pourrait se désengager par inadvertance. Pour plus de détails, référez vous aux instructions. Ne pas vous conformer à ces instructions pourrait causer des blessures graves ou la mort. Ne pas retirer l'étiquette.

Web Loop Harness Label

950706 Rev F

Fall arrest or restraint system connecting web loop/ Boucle de raccordement de toile de système de retenue ou d'arrêt de chute

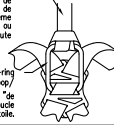

Harness, D-ring or Web Loop/ Boucle en "D" de harnais ou boucle de toile.

▲ WARNING/AVERTISSEMENT!

Only compatible connections may be made with web loops. Snap hooks (both self locking and non-locking types) connected into web loops may result in inadvertent disengagement. Refer to separate instructions for further details. Failure to follow these instructions may result in serious injury or death. Do not remove label.

Seuls des connexions compatibles doivent être faites avec les boucles de toile. Un maquetage (de type avec ou sans verrou) rattaché à une boucle de toile pourrait se désengager par inadvertance. Pour plus de détails, référez vous aux instructions. Ne pas vous conformer à ces instructions pourrait causer des blessures graves ou la mort. Ne pas retirer l'étiquette.

Étiquette de harnais de boucle de Web

9.0 INSPECTION AND MAINTENANCE LOG

SERIAL NUMBER: _____

MODEL NUMBER: _____

DATE PURCHASED: _____ **DATE FIRST USED:** _____

INSPECTION DATE	INSPECTION ITEMS NOTED	CORRECTIVE ACTION	MAINTENANCE PERFORMED
Approved By: _____			
Approved By: _____			
Approved By: _____			
Approved By: _____			
Approved By: _____			
Approved By: _____			
Approved By: _____			
Approved By: _____			
Approved By: _____			
Approved By: _____			
Approved By: _____			
Approved By: _____			
Approved By: _____			

This instruction applies to the following models:

1100092	1101116	1101439	1101643	1101797
1100181	1101117	1101440	1101644	1101798
1100195	1101118	1101441	1101645	1101800
1100230	1101119	1101450	1101646	1101801
1100231	1101120	1101451	1101647	1101802
1100232	1101121	1101452	1101649	1101803
1100233	1101214	1101453	1101650	1101804
1100245	1101215	1101455	1101651	1101805
1100246	1101216	1101456	1101653	1101806
1100247	1101217	1101457	1101654	1101807
1100299	1101218	1101458	1101654H	1101808
1100406	1101219	1101459	1101655	1101809
1100482	1101240	1101460	1101655H	1101810
1100520	1101241	1101461	1101656	1101812
1100521	1101250	1101462	1101656H	1101813
1100522	1101251	1101463	1101657	1101814
1100540	2104180	1101464	1101658	1101815
1100541	1101252	1101465	1101659	1101816
1100542	1101252H	1101466	1101660	1101817
1100543	1101253	1101467	1101661	1101818
1100550	1101253H	1101468	1101662	1101819
1100675	1101254	1101469	1101663	1101820
1100676	1101254H	1101470	1101664	1101821
1100700	1101255	1101471	1101665	1101822
1100701	1101255H	1101472	1101666	1101823
1100702	1101256	1101473	1101667	1101824
1100703	1101257	1101474	1101668	1101826
1100726	1101258	1101511	1101669	1101827
1100727	1101259	1101512	1101670	1101828
1100750	1101260	1101513	1101671	1101829
1100756	1101261	1101514	1101672	1101830
1100762	1101262	1101515	1101673	1101831
1100767	1101266	1101516	1101776	1101832
1100768	1101267	1101611	1101777	1101833
1100769	1101268	1101625	1101778	1101834
1100775	1101269	1101626	1101779	1101835
1100776	1101270	1101627	1101780	1101836
1100777	1101271	1101628	1101781	1101837
1100778	1160008	1101629	1101782	1101838
1100779	1101272	1101630	1101783	1101839
1100780	1101273	1101631	1101784	1101840
1100781	1101274	1101632	1101785	1101841
1100840	1101340	1101633	1101786	1101842
1100841	1101341	1101634	1101787	1101843
1100842	1101420	1101635	1101789	1101844
1100925	1101421	1101636	1101790	1101845
1100926	1101422	1101637	1101791	1101851
1100927	1101423	1101638	1101792	1101854
1100928	1101424	1101639	1101793	1101855
1100929	1101436	1101640	1101794	1101856
1101021	1101437	1101641	1101795	1101857
1101022	1101438	1101642	1101796	1101858

1101859	6116605	1102286	1102926	1103359
1101860	6116606	1102525	1102927	1103360
1101861	1102010ALT1	1102526	1102928	1103361
1101862	1102010	1102526H	1102929	1103375
1101863	1170002	1102527	1102930	1103376
1101864	1170003	1102528	1102950	1103377
1101866	6100771	1102529	1102951	1103378
1101867	6100772	1102529H	1102952	1103379
1101869	6100776	1102530	1102953	1103383
1101870	6100777	1102531	1102954	1103384
1101871	6116604	1102532	1102955	1103385
1101872	6116605	1102533	1102956	1103386
1101873	6116606	1102534	1102957	1103393
1101874	6116607	1102536	1102962	1103394
1101890	6116609	1102537	1102963	1103395
1101891	6116610	1102538	1102964	1103510
1101892	1102025	1102539	1102965	1106725
1101893	1102026	1102540	1102966	1106726
1101909	1102027	1102541	1102972	1106727
1101910	1102028	1102542	1102973	1106728
1101911	1102029	1102543	1103251	1106729
1101912	1102030	1102543H	1103252	1106730
1101913	1102031	1102546	1103253	1103511
1101977	1102032	1102548	1103254	1103512
1101978	1102033	1102549	1103255	1103513
1101979	1102034	1102556	1103256	2104168
1101980	1102035	1102557	1103257	2104169
1101981	1102036	1102558	1103258	2104170
1102000	1102037	1102559	1103261C	2104171
1160002	1102038	1102560	1103262	2104172
1170002	1102039	1102561	1103262C	2104173
1170003	1102040	1102562	1103263	2104174
2104177	1102041	1102563	1103263C	2104175
2104181	1102042	1102564	1103264	2104176
2104182	1102043	1102565	1103265	2104178
1102000H	1102082	1102566	1103266	2104179
1102001	1102083	1102875	1103267	1103611
1160000	1102084	1102875C	1103270	1103612
1102002	1102086	1102876	1160001	1103800
1102003	1102090	1102877	1103270ALT1	1103801
1102004	1102132	1102878	1103270	1103802
1102005	1102133	1102879	1160001	1103803
1102008	1102134	1102880	1103321	1103803ALT
1102009	1102135	1102901	1103350	1103803
1102010	1102200	1102903	1103351	1103804
1170002	1102201	1102904	1103352	1103805
1170003	1102205	1102905	1103353	1103806
6100771	1102206	1102907	1103354	1103807
6100772	1102207	1102908	1103355	1103808
6100776	1102257	1102911	1103356	1103809
6100777	1102270	1102912	1103357	1103810
6116604	1102271	1102925	1103358	1103811

1103812	1104736	1104882	1105375C	1105728
1103813	1104739	1104885	1105376	1105729
1103814	1104740	1104886	1105377	1105732
1103825	1104741	1104890	1105378	1105733
1103826	1104742	1104891	1105379C	1105734
1103827	1104743	1104892	1105382	1105735
1103828	1104744	1104893	1105383	1105750
1103829	1104745	1104894	1105384	1105751
1103831	1104746	1104900	1105400	1105752
1103836	1104747	1104901	1105401	1105753
1103837	1104748	1104902	1105405	1105754
1103852	1104749	1104903	1105406	1105755
1103853	1104775	1104904	1105407	1105801
1103854	1104776	1104905	1105408	1105802
1103855	1104777	1104906	1105409	1105803
1103856	1104778	1104907	1105410	1105804
1103860	1104779	1104908	1105411	1105825
1103861	1104780	1104909	1105450	1102353
1103875	1104781	1104910	1105475	1105825C
1103876	1104782	1104911	1105476	1105826
1103877	1104783	1104912	1105477	1102351
1103878	1104800	1104914	1105478	1105827
1103879	1104801	1104915	1105479	1102352
1103880	1104803	1104916	1105480	1105828
1103882	1104804	1104917	1105481	1102354
1103884	1104805	1104918	1105482	1105829
1103885	1104806	1104919	1105483	1105830
1103886	1104850	1104920	1105484	1102355
1103888	1104851	1104921	1105487	1105830C
1104125	1104852	1104924	1105488	1105831
1104126	1104853	1104950	1105489	1102350
1104625	1104854	1104952	1105490	1105832
AA7059A	1104855	1104953	1105491	1105833
AA7060A	1104856	1104954	1105500	1105834
1104626	1104857	1104955	1105555	1105835
1104627	1104858	1105000	1105556	1105836
1104628	1104859	1105001	1105577	1105837
1104629	1104860	1105002	1105650	1105838
1104630	1104861	1105003	1105651	1105840
1104632	1104863	1105004	1105652	1105850
1104633	1104866	1105005	1105675	1105851
1104635	1104871	1105300	1105676	1105852
1104636	1104872	1105301	1105677	1105853
1104650	1104873	1105325	1105678	1105854
1104725	1104874	1105326	1105679	1105900
1104729	1104875	1105327	1105680	1105901
1104730	1104876	1105328	1105681	1105925
1104731	1104877	1105329	1105682	1105926
1104732	1104878	1105330	1105683	1105950
1104733	1104879	1105331	1105725	1105951
1104734	1104880	1105350	1105726	1105952
1104735	1104881	1105375	1105727	1105953

1105954	1106072	1106303	1106410	1106903
1105975	1106074	1106304	1106411	1106904
1106000	1106076	1106305	1106414	1106905
1106001	1106077	1106306	1106425	1106950
1106002	1106078	1106307	1106426	1106951
1106003	1106079H	1106308	1106427	1106952
1106004	1106080H	1106309	1106450	1106953
1106005	1106081	1106310	1106450H	1106954
1106006	1106082H	1106325	1106451	1106975
1106007	1106083H	1106326	1106451H	1106976
1106008	1106100	1106327	1106452	1106977
1106009	1106101	1106328	1106452H	1106978
1106010	1106102	1106329	1106453	1107000
1106011	1106103	1106330	1106453H	1107001
1106012	1106104	1106331	1106454	1107002
1106013	1106105	1106332	1106455	1107003
1106017	1106106	1106333	1106456	1107025
1106018	1106107	1106334	1106476	1107026
1106019	1106108	1106350	1106477	1107027
1106020	1106109	1106351	1106478	1107075
1106021	1106110	1106352	1106479	1107125
1106022	1106111	1106354	1106480	1107126
1106023	1106114	1106355	1106481	1107127
1106024	1106115	1106356	1106482	1107128
1106025	1106116	1106357	1106550	1107129
1106028	1106117	1106365	1106675	1107150
1106028H	1106118	1106366	1106676	1107151
1106029	1106119	1106367	1106677	1107152
1106030	1106120	1106368	1106679	1107153
1106031	1106125	1106369	1106680	1107154
1106032	1106126	1106370	1106681	1107200
1106033	1106127	1106375	1106682	1107201
1106034	1106150	1106376	1106683	1107202
1106035	1106151	1106377	1106684	1107203
1106036	1106152	1106378	1106687	1107204
1106037	1106175	1106379	1106688	1107205
1106039	1106180	1106380	1106700	1107206
1106040	1106200	1106381	1106701	1107207
1106041	1106201	1106382	1106702	1107225
1106048	1106203	1106383	1106703	1107250
1106055	1106204	1106384	1106704	1107251
1106056	1106205	1106385	1106750	1107252
1106057	1106207	1106386	1106751	1107275
1106058	1106208	1106400	1106754	1107276
1106059	1106209	1106401	1106755	1107277
1106063	1106210	1106403	1106756	1107278
1106066	1106211	1106404	1106800	1107279
1106067	1106275	1106405	1106801	1107400
1106068	1106279	1106406	1106802	1107400C
1106069	1106300	1106407	1106900	1107402
1106070	1106301	1106408	1106901	1107402C
1106071	1106302	1106409	1106902	1107403

1107404	1107475	1107806H	1108101	1109000
1107405	1107475C	1107807	1108102	1109002
1107406	1107476	1107807H	1108103	1109062
1107406C	1107476C	1107808	1108104	1109075
1107407	1107477	1107809	1108105	1109076
1107407C	1107477C	1107810	1108106	1109077
1107408	1107478	1107811	1108107	1109078
1107408C	1107478C	1107812	1108108	1109079
1107409	1107479	1107813	1108109	1109080
1107410	1107479C	1107814	1108125	1109102
1107415	1107480	1107815	1108126	1109105
1107416	1107480C	1107816	1108127	1109106
1107417	1107500	1107817	1108128	1109107
1107418	1107501	1107817H	1108129	1109108
1107419	1107525	1107818	1108130	1109109
1107420	1107526	1107819	1108131	1109110
1107421	1107550	1107820	1108132	1109111
1107422	1107551	1107821	1108133	1109121
1107425	1107575	1107822	1108134	1109125
1107425C	1107576	1107823	1108175	1109126
1107426	1107577	1107824	1108176	1109127
1107427	1107578	1107825	1108177	1109128
1107427C	1107579	1107828	1108178	1109129
1107428	1107580	1107829	1108179	1109130
1107428C	1107600	1107830	1108184	1109142
1107429	1107626	1107831	1108185	1109143
1107429C	1107629	1107832	1108186	1109144
1107430	1107630	1107833	1108187	1109145
1107430C	1107650	1107834	1108188	1109150
1107450	1107651	1107836	1108189	1109151
1107450C	1107652	1107850	1108190	1109152
1107451	1107653	1107851	1108225	1109400
1107451C	1107656	1107855	1108226	1109425
1107452	1107658	1107875	1108227	1109426
1107452C	1107659	1107926	1108228	1109427
1107453	1107725	1107950	1108229	1109429
1107453C	1107726	1107951	1108300	1109431
1107454	1107727	1107952	1108301	1109441
1107454C	1107775	1107954	1108302	1109446
1107455	1107776	1107957	1108305	1109447
1107455C	1107777	1107958	1108307	1109448
1107460	1107778	1107959	1108308	1109449
1107461	1107781	1107960	1108309	1109450
1107462	1107782	1107962	1108310	1109451
1107463	1107783	1108000	1108311	1109475
1107465	1107784	1108001	1108375	1109500
1107466	1107801	1108002	1108376	1109501
1107467	1107802	1108003	1108377	1109502
1107468	1107803	1108025	1108378	1109503
1107469	1107804	1108026	1108379	1109550
1107470	1107805	1108034	1108380	1109551
1107471	1107806	1108100	1108400	1109552

1109553	1110590	1110803	1111332	3103389
1109554	1110591	1110810	1111500H	3103390
1109555	1110600	1110811	1111501H	3103395
1109556	2104205	1110812	1111502H	3103420
1109557	1110601	1110813	1111503H	3103450
1109558	1110602	1110814	1111504H	3103451
1109559	1110603	1110820	1111505H	3103452
1109560	1110604	1110830	1111506H	3103453
1109561	1110605	1110831	1111507H	3103471
1109575	1110606	1110832	1111508H	3103515
1109651	1110608	1110850	1111509H	3103520
1109652	1110618	1110851	1111575	3103521
1109653	1110625	1110852	1111577	3103522
1109654	1110626	1110853	1111578	3103523
1109675	1110675	1110854	1111579	3103524
1109676	1110700	1110855	1111580	3103543
1109677	1110701	1110856	1111581	3103544
1109678	1110702	1110857	1111582	3103547
1109850	1110704	1110858	1111583	3103549
1109851	1110725	1110859	1111584	
1109852	1110727	1110930	1111585	
1109853	1110750	1110935	1111586	
1109854	1110751	1110942	1111591	
1109855	1150054	1110950	1111592	
1109885	1110752	1110951	1111593	
1109886	1150058	1110952	1111594	
1109975	1110753	1110953	1111595	
1109976	1110754	1110954	1111610	
1109977	1110755	1110955	1111611	
1110025	1110760	1110956	1111612	
1110026	1110761	1110990	1111613	
1110027	1110762	1110992	1310065	
1110028	1110770	1110994	1370111	
1110029	1110771	1110995	1370112	
1110030	1110772	1111000	3103300	
1110052	1110773	1111001	3103301	
1110570	1110774	1111002	3103330	
1110575	1110780	1111003	3103331	
1110575H	1110781	1111004	3103332	
1110576	1110782	1111275	3103333	
1110576H	1110783	1111276	3103334	
1110577	1110784	1111277	3103335	
1110577H	1110785	1111278	3103336	
1110578	1110786	1111279	3103337	
1110578H	1110787	1111280	3103350	
1110582	1110792	1111325	3103351	
1110586	1110793	1111326	3103375	
1110587	1110800	1111327	3103386	
1110588	1110801	1111330	3103387	
1110589	1110802	1111331	3103388	

Additional Model Numbers may appear on the next printing.

WARRANTY

Equipment offered by DBI-SALA are warranted against factory defects in workmanship and materials for a period of two years from date of installation or use by the owner, provided that this period shall not exceed two years from the date of shipment. Upon notice in writing, DBI-SALA will promptly repair or replace all defective items. DBI-SALA reserves the right to elect to have any defective item returned to its plant for inspection before making a repair or replacement. This warranty does not cover equipment damages resulting from abuse, damage in transit, or other damage beyond the control of DBI-SALA. This warranty applies only to the original purchaser and is the only one applicable to our products, and is in lieu of all other warranties, expressed or implied.



A Capital Safety Company

USA

3833 SALA Way
Red Wing, MN 55066-5005
Toll Free: 800-328-6146
Phone: (651) 388-8282
Fax: (651) 388-5065
www.capitalsafety.com

Canada

260 Export Boulevard
Mississauga, Ontario L5S 1Y9
Toll Free: 800-387-7484
Phone: (905) 795-9333
Fax: (905) 795-8777
www.capitalsafety.com

This manual is available for download at www.capitalsafety.com.



Certificate No. FM 39709