

4 Get Control

Your SVS PB-4000 Subwoofer can be controlled from the new SVS Mobile App, an included IR Remote Control or via the front panel for unprecedented flexibility when optimizing performance for room layout, speakers, system set-up and more.

Download The App

The SVS App is the easiest and most convenient way to access all of the advanced control features available on your PB-4000, from the comfort of your favorite seat.



For iOS & Android Devices

GET IT ON Google Play

Download on the App Store

In The Box

The included IR remote is another convenient way to adjust your subwoofer's advanced control settings.

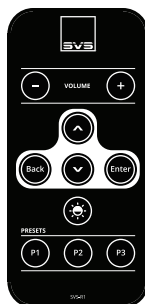

On The Subwoofer

The front panel features an intuitive user interface with simplified button controls that can be used to adjust the majority of the subwoofer's advanced control settings.

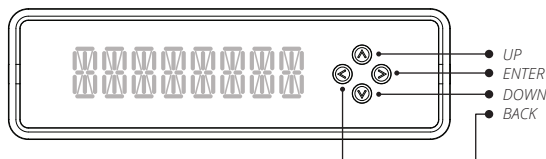

5 Get Calibrated

Set the PB-4000 volume to -10, then run auto-set-up in the AV receiver/processor. It is important to re-run your receiver's calibration set-up if you are upgrading from another subwoofer and each time you move the subwoofer.

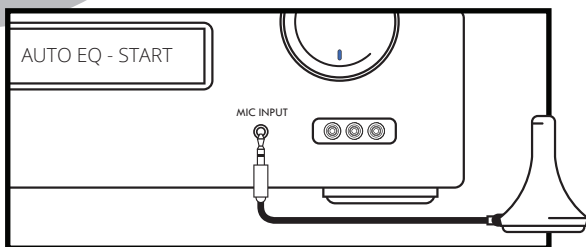

If your set-up doesn't include an Auto-EQ feature, adjust the subwoofer volume control to level-match to your loudspeakers.

For additional guidance on recommended crossover settings, visit our Merlin Subwoofer Matching tool at www.svsound.com/merlin, or contact our Sound Experts.



Quick Start Guide PB-4000

Congratulations on choosing the SVS PB-4000, one of the most powerful and advanced subwoofers available. We know you're anxious to get it cranking so the following steps will guide you through the quick and easy installation process.

We strongly recommend reading the PB-4000 Owner's Manual to get the best possible performance out of your new subwoofer. You'll find useful information about subwoofer placement, connections, DSP functions and more. The full SVS PB-4000 Owner's Manual can be found here: www.svsound.com/pb-4000-manual

Unbox It

If you followed the PB-4000 Subwoofer unboxing instructions properly you will have the following items in front of you. Please confirm all pieces are available before continuing.

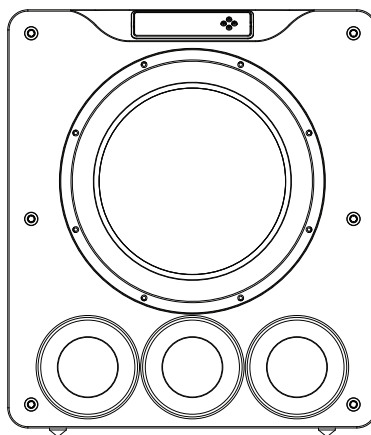

[PB-4000 Subwoofer]

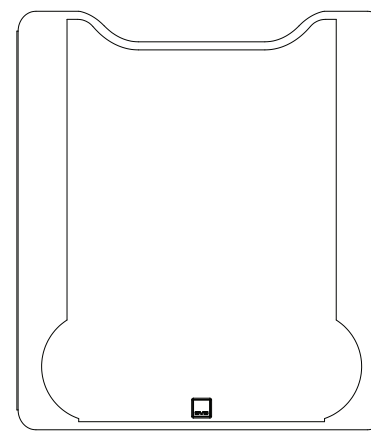

[Removable Metal Grille]

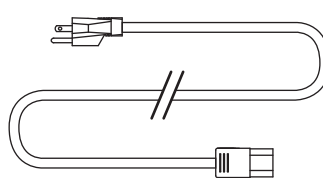

[Detachable Power Cord]



[Port Plug]

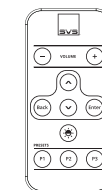

[IR Remote Control]

Register Your New SVS Product:



Thank you for choosing SVS! Registering your SVS product expedites any Sound Experts support requests, confirms your warranty registration and provides a proof of purchase. Plus, as a registered customer, you'll be the first to get SVS news and updates.

Register your product now at: www.svsound.com/register

REGISTER

REVIEW

Review Your New SVS Product:
Your SVS product is built with the highest standards of engineering excellence to achieve stunning sound quality and dynamics. Honest feedback is important to us and others making decisions about audio products. Please share your ownership experience with the SVS community by writing a review today.



Review your product now at: www.svsound.com/review

2 Set It Up

The location of your subwoofer in the listening environment can affect its performance. If possible, start with corner placement on the same wall as the front speakers, or anywhere along the front stage in between or outside of your main speakers.

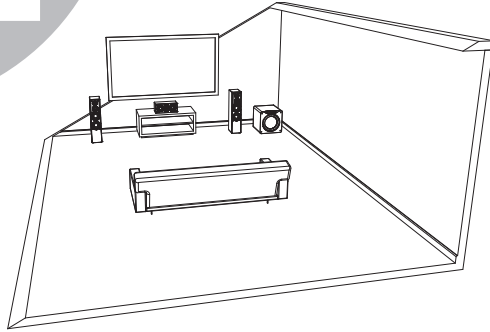

Corner Placement: offers huge impact and reduces the potential to encounter bass nulls, or 'dead spots'. If "boominess" occurs, you can try pulling it away from the wall and using the DSP tuning controls to smooth performance.

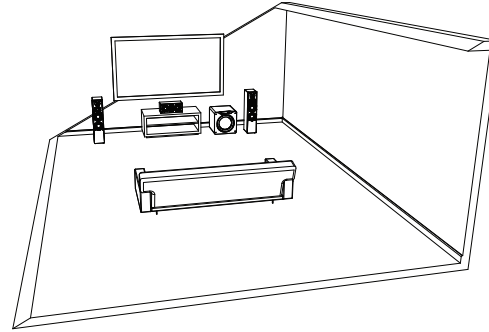

Front Placement: In between or to the side of the front channel speakers often results in the best blending with the main speakers and center channel and minimizes localization effects.

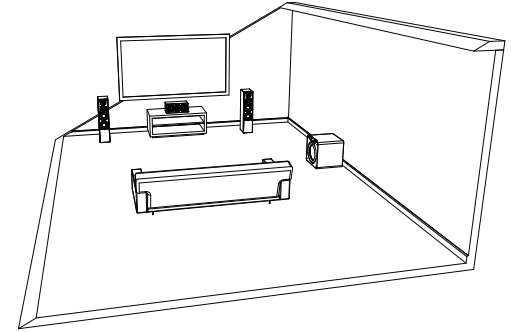

Side Wall Placement: Side wall placement is less frequently used but can be an effective subwoofer location for excellent accuracy and output.

3 Hook It Up

For most set-ups, a single RCA subwoofer interconnect cable running from the AV Receiver's "SUB 1" output to the PB-4000's "LFE" line level input is all that's required to connect the subwoofer into your system. If you run separate Preamp and Power Amplifiers, follow the "Line Level Connection - Stereo Receiver or Preamp Left/Right Channels" connection guide below.

Line Level Connection - Single LFE Channel

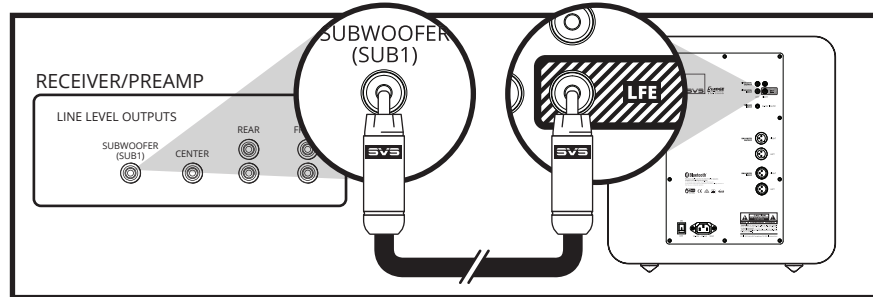

Line Level Connection - Stereo Receiver or Preamp Left/Right Channels

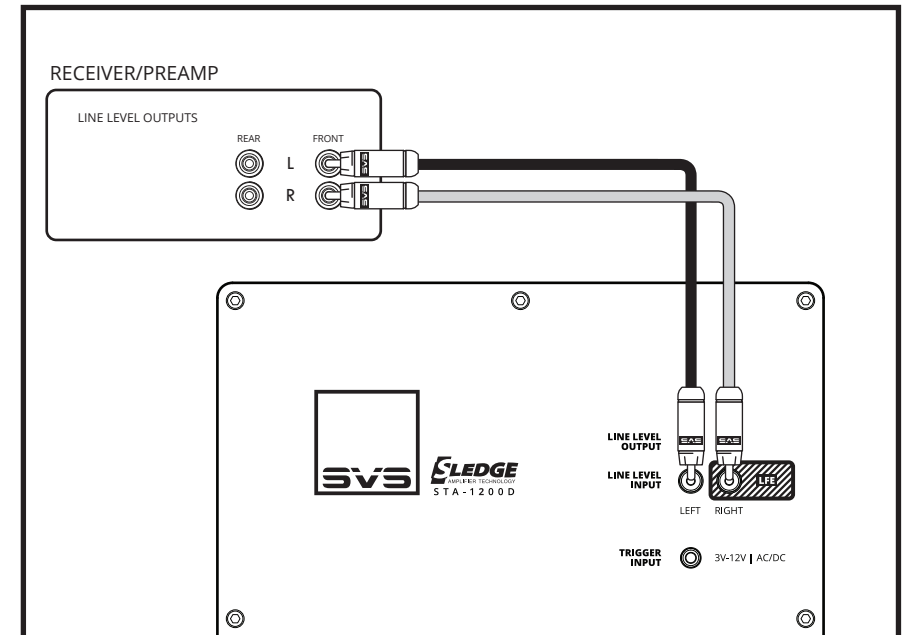

Need Help?

Our Sound Experts are standing by to help with subwoofer placement, installation, calibration, AV receiver settings, room rattle and anything else you need advice about. Just call, email or chat online with our Sound Experts:

(877) 626-5623 | custservice@svsound.com | www.svsound.com