

1

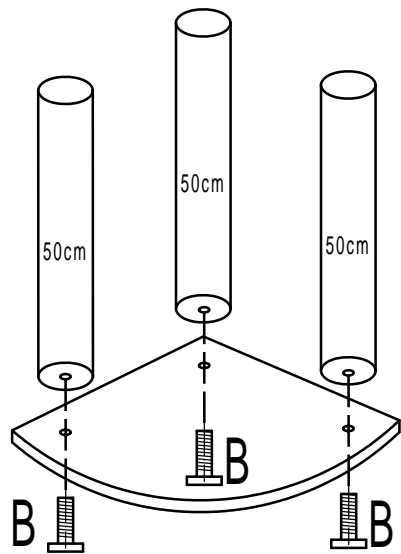

2

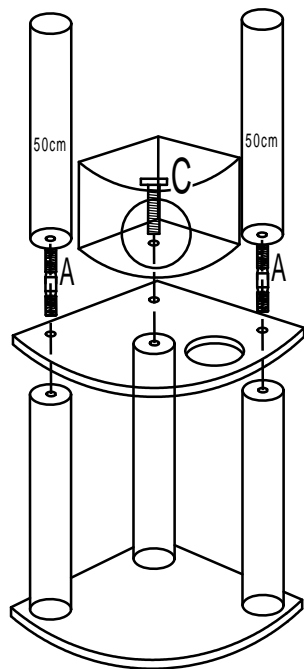



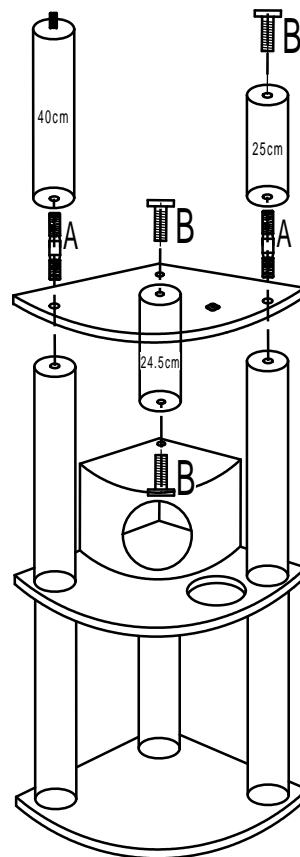

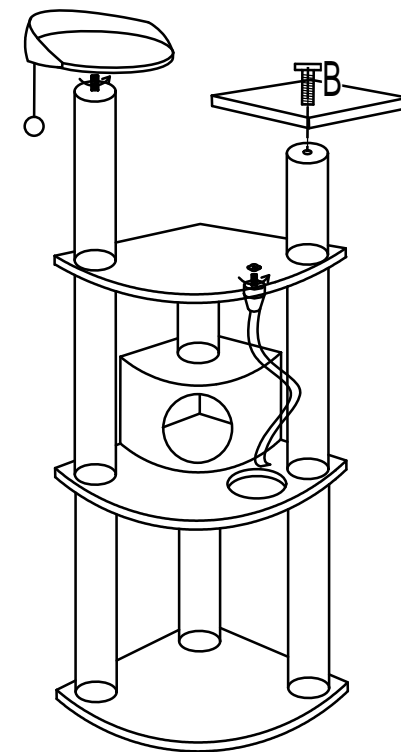

3



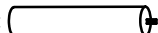
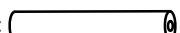



4



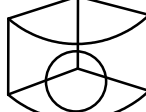



- 1 ×  $\varnothing 9 \times 24.5\text{cm}$
- 1 ×  $\varnothing 9 \times 25\text{cm}$
- 1 ×  $\varnothing 9 \times 40\text{cm}$
- 5 ×  $\varnothing 9 \times 50\text{cm}$

- 1 ×  $48.5 \times 48.5\text{cm}$
- 1 ×  $48.5 \times 48.5\text{cm}$
- 1 ×  $48.5 \times 48.5\text{cm}$

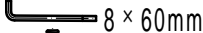
- 1 ×  $30 \times 30 \times 25\text{cm}$
- 1 ×  $\varnothing 34.5\text{cm}$

- 1 ×  $34.5 \times 34.5\text{cm}$
- 1 × 

- 1 ×  $8 \times 60\text{mm}$
- 4 ×  $\varnothing 8 \times 70\text{mm}$ (A)
- (6+1) ×  $\varnothing 8 \times 40\text{mm}$ (B)
- 1 ×  $\varnothing 8 \times 60\text{mm}$ (C)