

H570 - Dual Display Kit for AV Credenza

Beautifully executed video conferencing.

To reduce the risk of severe injury or death to persons, review these installation safety steps before proceeding:

1. Read all installation instructions for AV Credenza and AV Credenza accessories before beginning any installation.
2. When supporting one or more displays using H544 Support Kit for AV Credenza, always install the legs. Failure to support the weight of one or more displays to the ground may result in injury.
3. Always use H570 Dual Display Kit for AV Credenza in combination with the display supports and legs of H544 Support Kit. Failure to support the weight of one or more displays to the ground may result in injury.
4. Anchor the AV Credenza to the wall for all installations.
5. Use the wood cleat provided for all installations.
6. Heavy duty SNAPTOGGLE brand wall anchors and 3/8" diameter screws are provided for your convenience. While these wall anchors and screws are suitable for many drywall and steel stud installations, a professional should determine the best anchoring hardware and method for each specific installation.
7. If you discover a defect, please contact service@hecklerdesign.com.

CAUTION: Shock Hazard

AV Credenza is an aluminum enclosure and therefore is electrically conductive. Like all metal enclosures AV Credenza should be grounded by a professional to reduce the risk of shock due to static electricity or electrical shorts. AV Credenza features two ground lug locations for this purpose. Bonding AV Credenza to a grounded PDU via these grounding lugs is recommended.

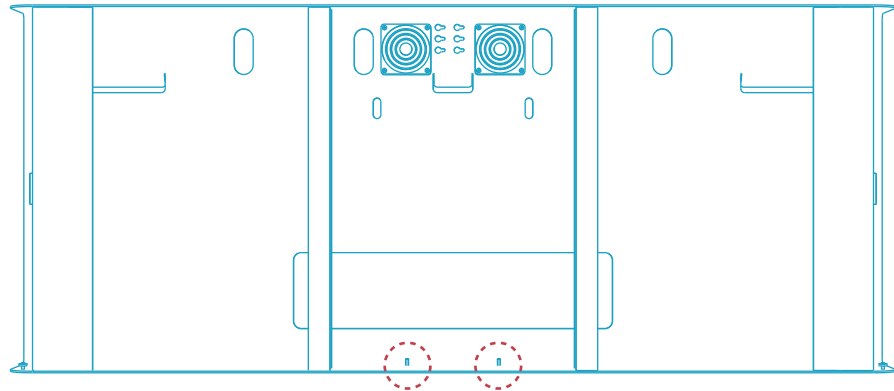

grounding lug locations

IN THE BOX

- A** 2 x Lefthand - Dual Display Rail
- B** 2 x Righthand - Dual Display Rail
- C** 2 x Center Bracket
- D** 4 x Dual Display Rail Adapter
- E** 4 x Locknut M8 x 1.25mm
- F** 16 x Screw, M8 x 1.25mm Thread, 16mm Long
- G** 1 x Hex Key, 6mm
- H** 4 x SNAPTOGGLE Wall Anchors
- I** 4 x Screw, 3/8", 3" Long
- J** 4 x Spacer
- K** 4 x Washer
- L** 1 x Display-Mounting Screws and Spacers
- M** 8 x Rolling Display Anchor

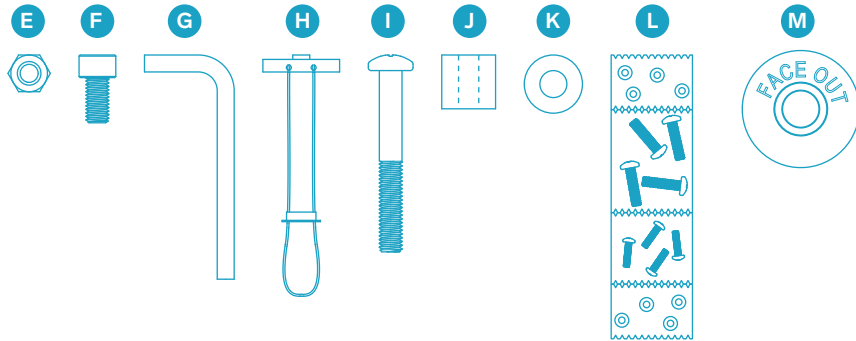
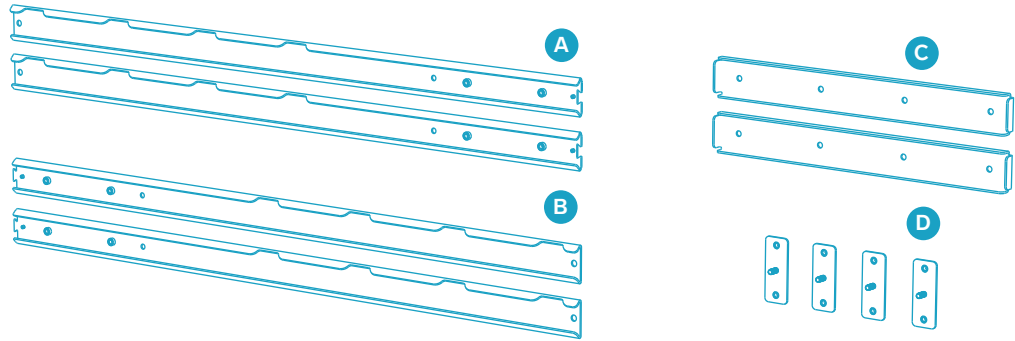

TOOLS NEEDED

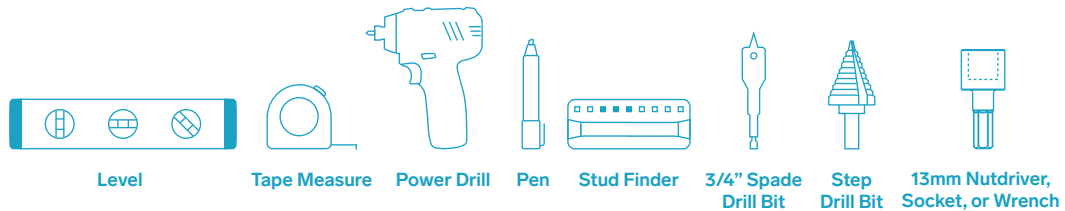

STEP 1

Install display support anchors 600mm apart.



Note: Display support anchors are included with H544 - Support Kit for AV Credenza.

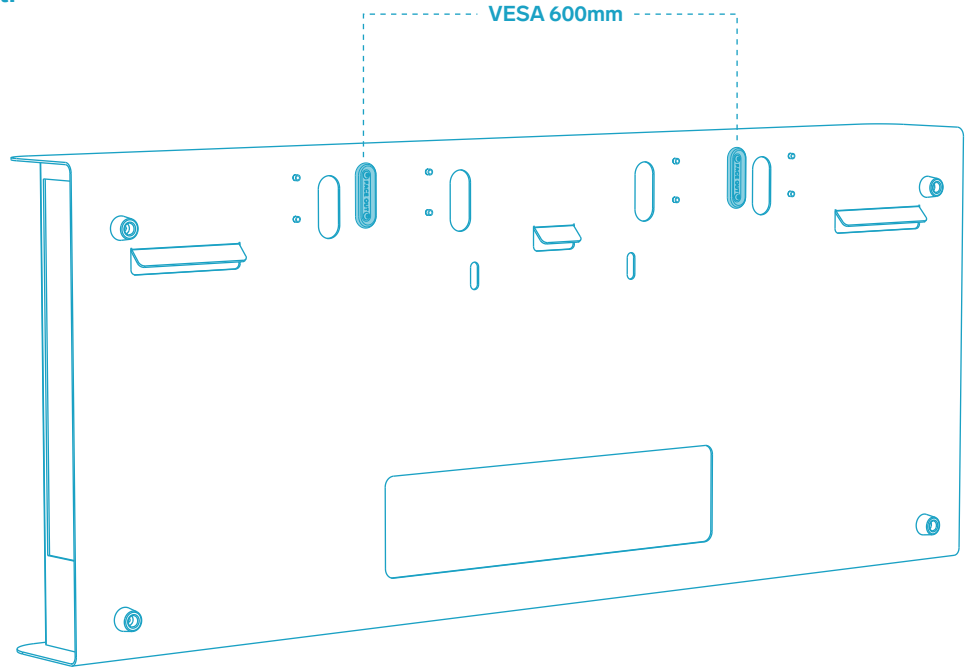
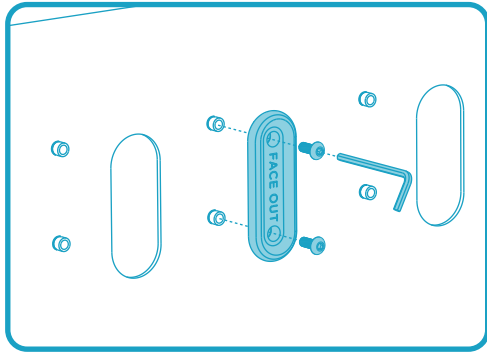

STEP 2

Install AV Credenza to the wall.

Using two people, carefully hang AV Credenza body with legs to the French cleat. As you lower the AV Credenza to the cleat, take care to align the cleat's anchoring posts to the corresponding slots in the back wall of AV Credenza.

Check to ensure all three mounting flanges in the back of AV Credenza body are seated flush on the top face of the French cleat.

For complete wall installation instructions, refer to the AV Credenza Instruction Guide. Go to heckler.design/H543 or scan the QR code below.



For complete legs and display supports installation instructions, refer to the Support Kit for AV Credenza Instruction Guide. Go to heckler.design/H544 or scan the QR code below.

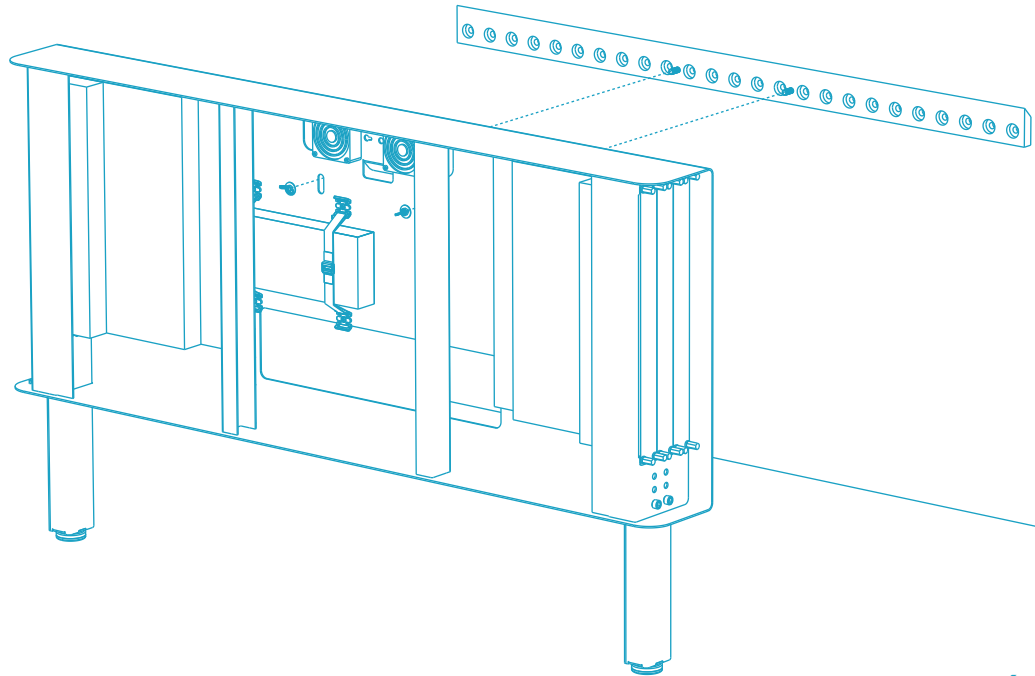

STEP 3

Fasten AV Credenza to the French cleat.

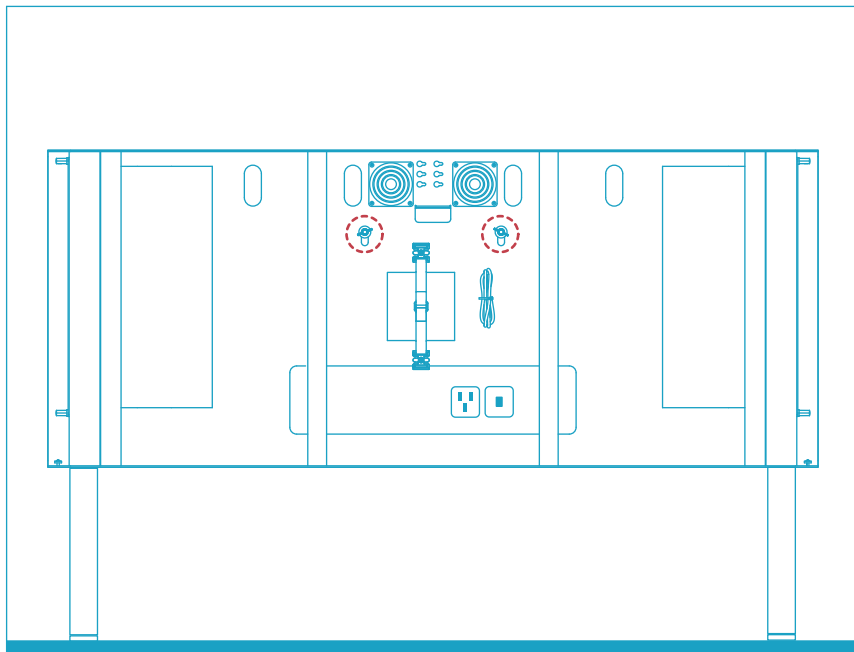

WARNING



Tip over hazard.

Important Safety Step:

Using the wingnuts provided, securely fasten the AV Credenza to the French cleat.

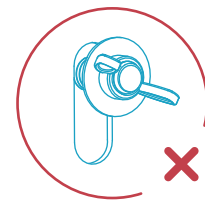
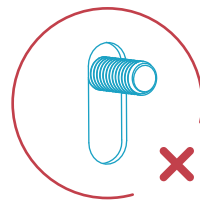
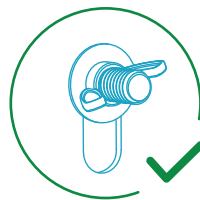

STEP 4

Take note your camera clearance.



Measure the distance between the top surface of AV Credenza and the desired location of the bottom edge of your display. Note the measurement.



Distance A =

Camera Mount is included with AV Credenza. For complete Camera Mount installation instructions, refer to the AV Credenza Instruction Guide Page 14. Go to heckler.design/H543 or scan the QR code below.

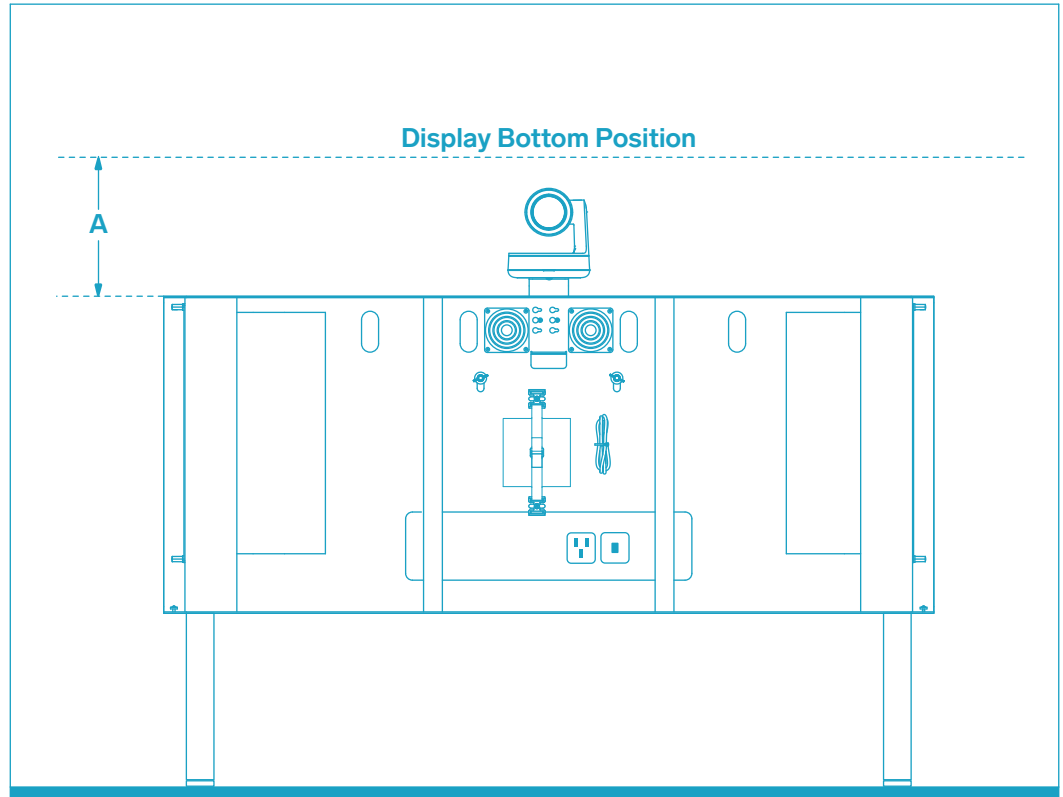

STEP 5

Measure and note your display's mounting positions.



Measure B and C.
Note the measurements.

 Distance B = _____

 Distance C = _____

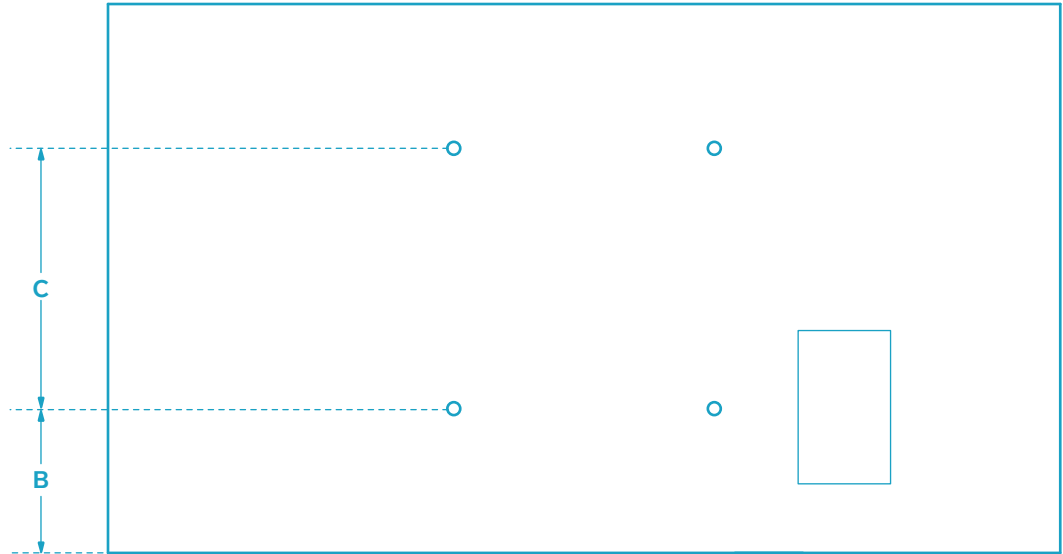

STEP 6

Install display rail adapters to display supports.



Use the three measurements you noted in the previous steps to locate the display rail adapters and fasten them in place.

Display supports are included with H544 - Support Kit for AV Credenza.

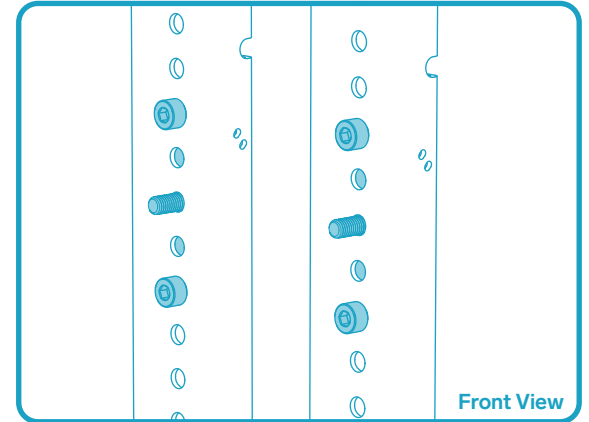
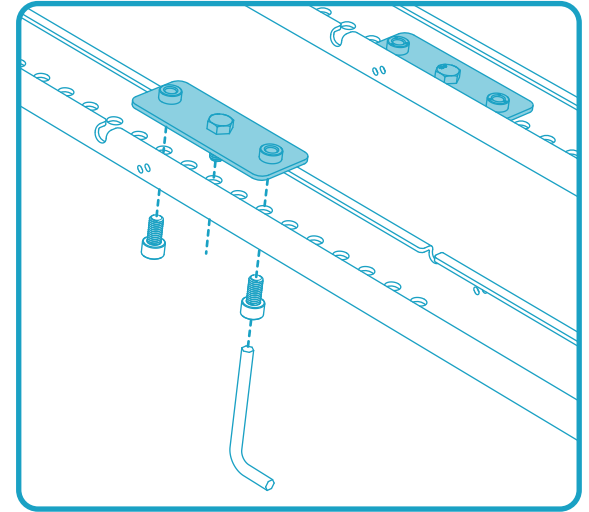
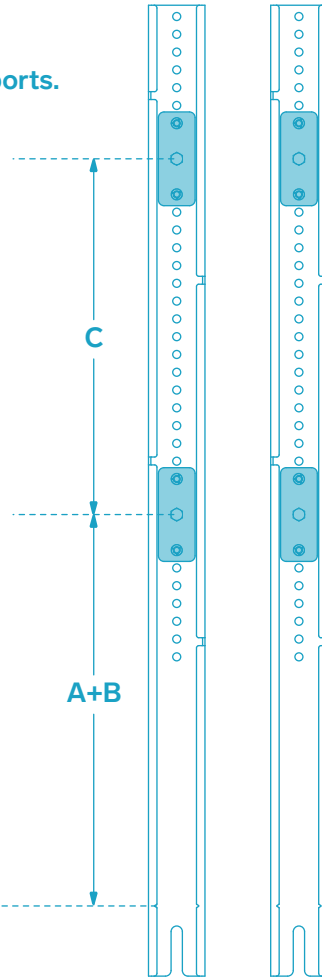
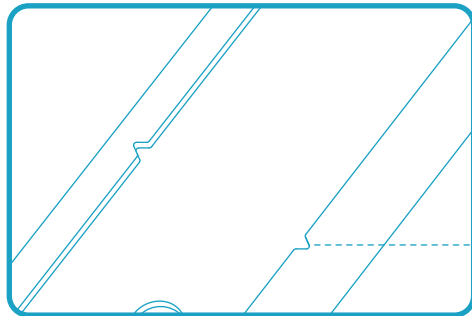

Front View

STEP 7

Route display and HDMI cables.



Route power and HDMI cables from the bottom of the display supports through the exit points on the side of the display supports.

Zip ties are included with H544 - Support Kit for AV Credenza. Use zip ties to secure the cables near their exit points.

Tip: You may need to source long power cables and long HDMI cables to reach from the displays to the devices within AV Credenza.

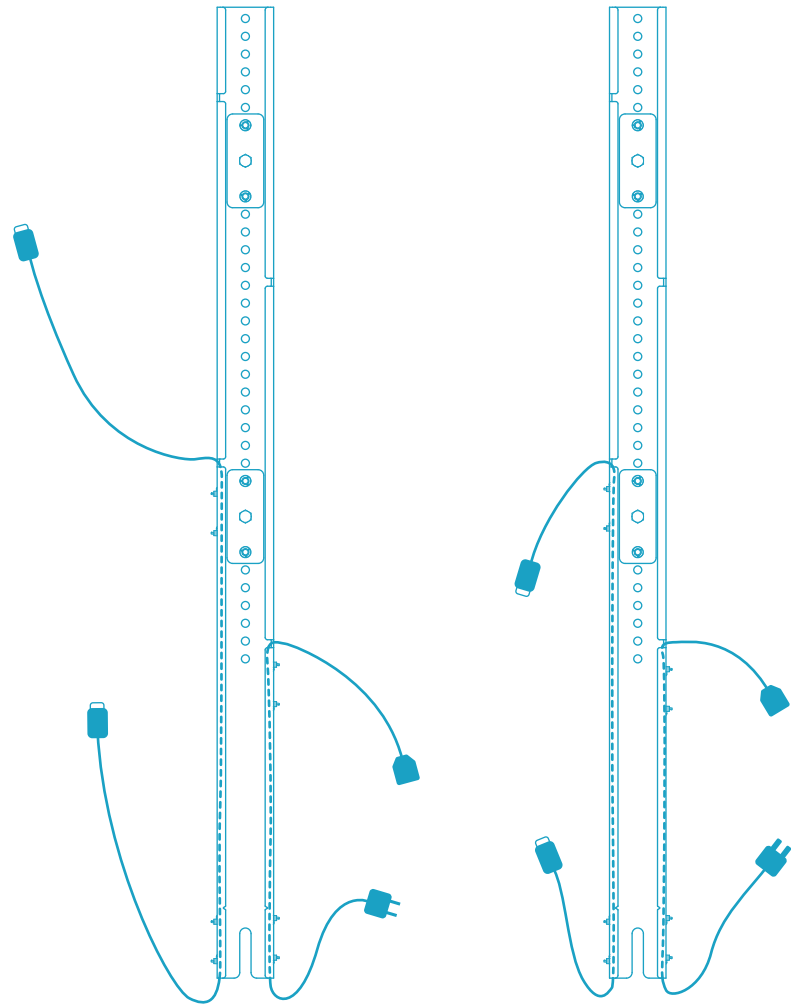
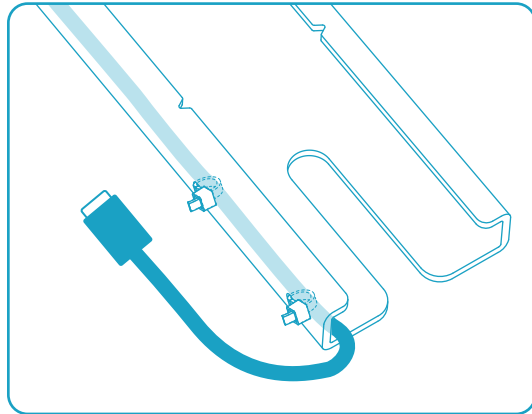

STEP 8

Install the display supports to AV Credenza.

Important safety note:

Use two people for this step.

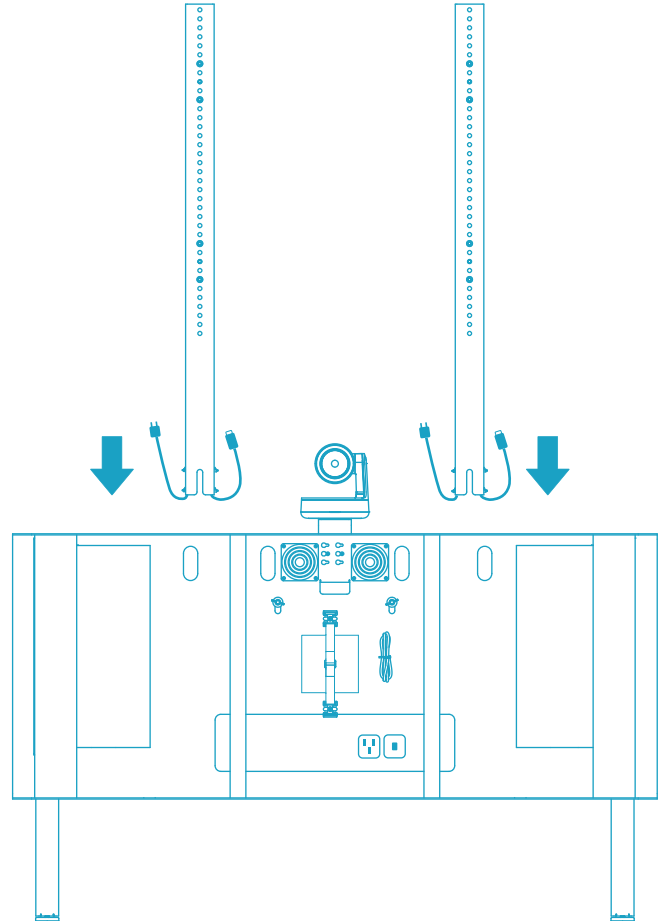
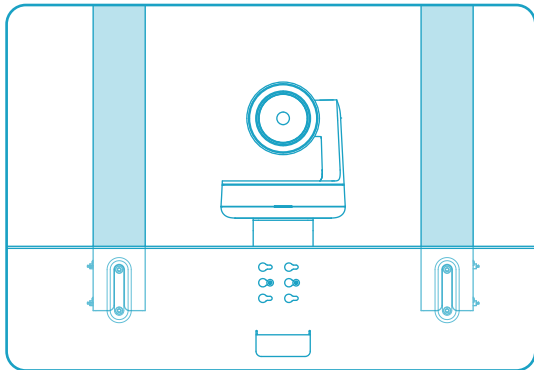
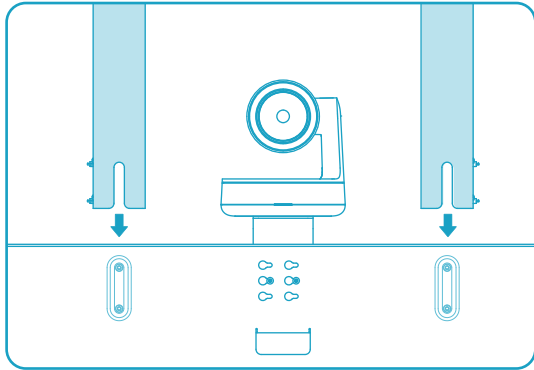

STEP 9

Assemble dual display rails.

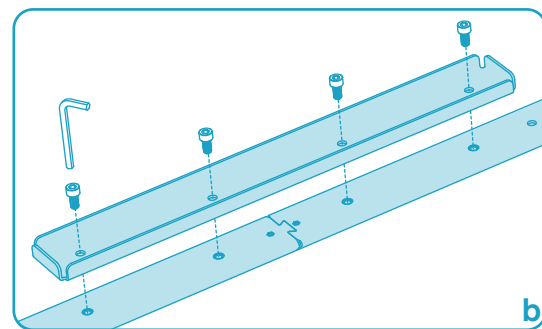
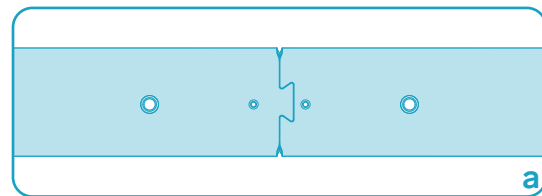
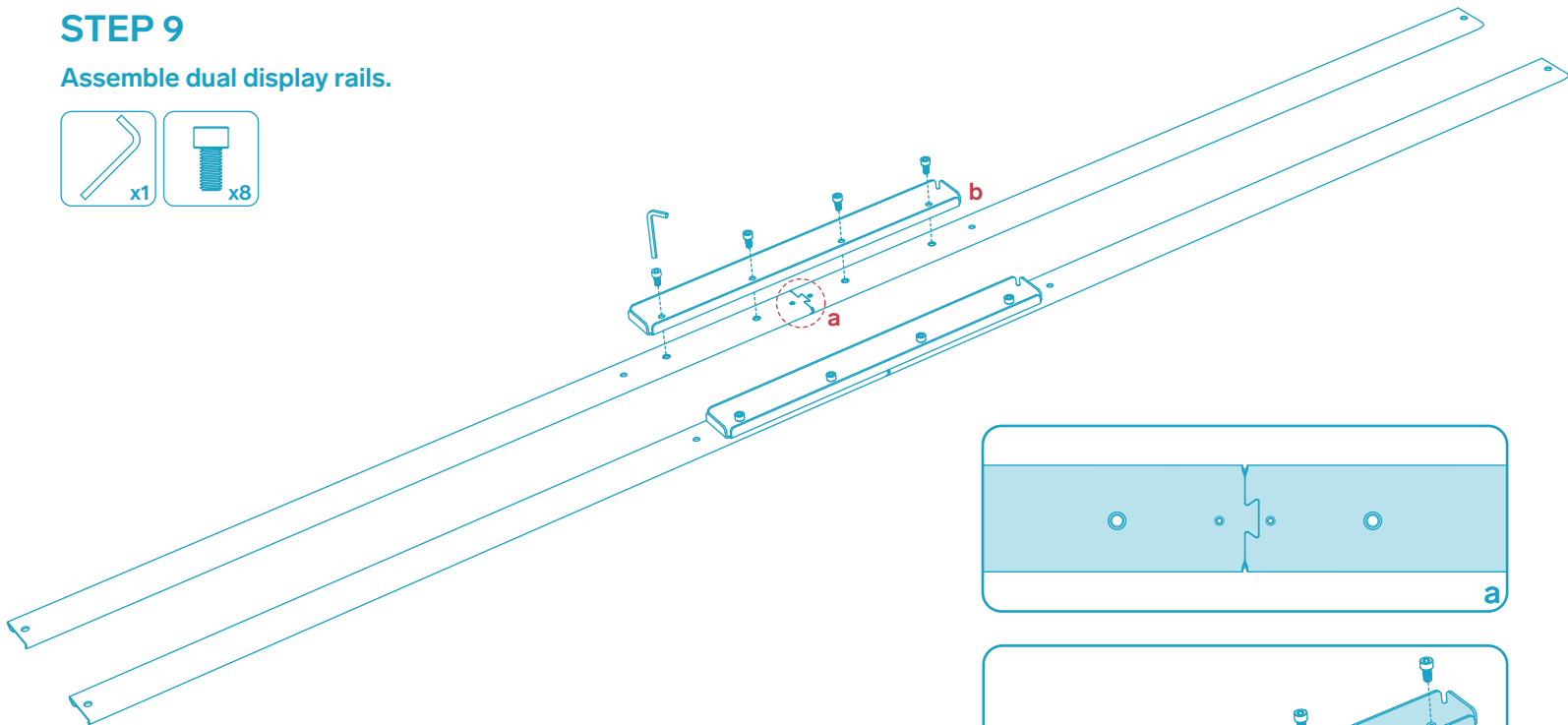
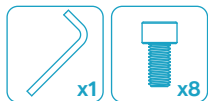

STEP 10

Temporarily install the dual display rails and mark hole positions.



1. Temporarily fasten each dual display rail using the locknuts provided.

Important note: Install each rail with the notched side up.

2. Check each rail for straightness and level.
3. Using the rails as your template, mark the wall in the four end positions shown.

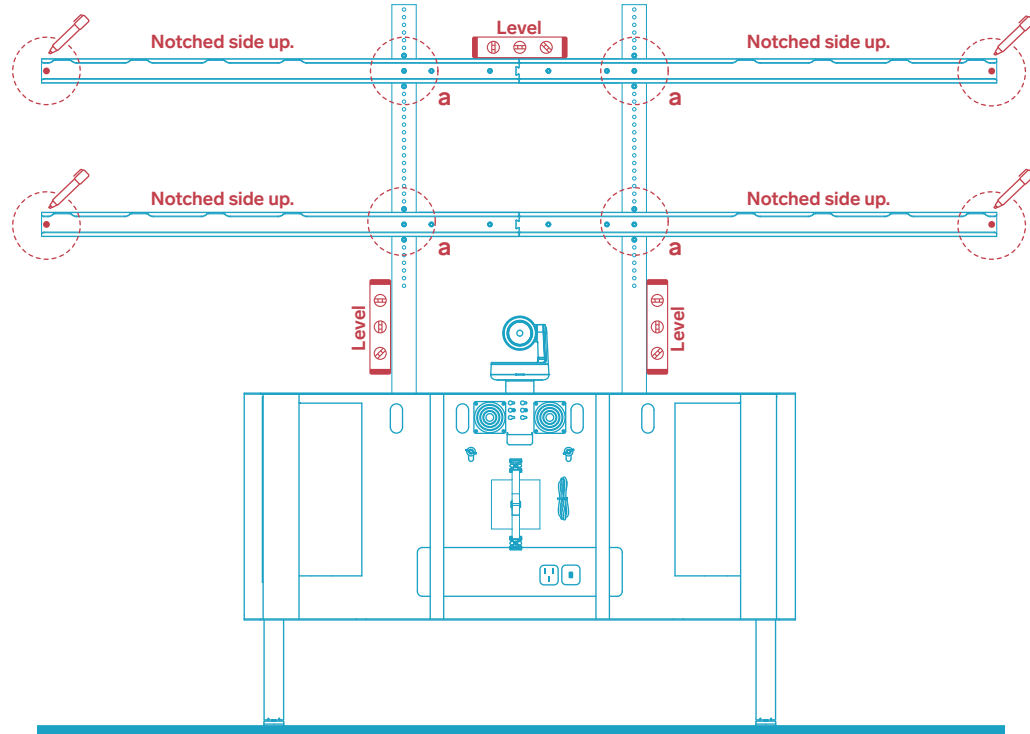
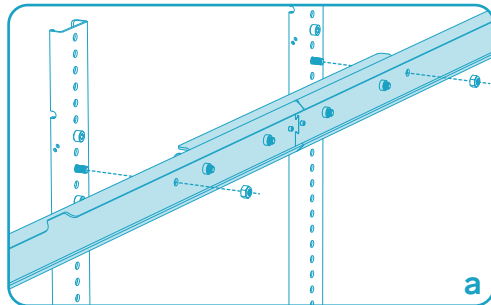

STEP 11

Install SNAPTOGGLES wall anchors.

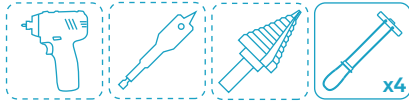

Important notes:

The following steps should be performed by a professional.

Heavy-duty SNAPTOGGLE anchors, screws, and washers are provided for your convenience. A professional should determine if these fasteners are appropriate for your specific installation.

For SNAPTOGGLE installation, follow the steps on the next page.

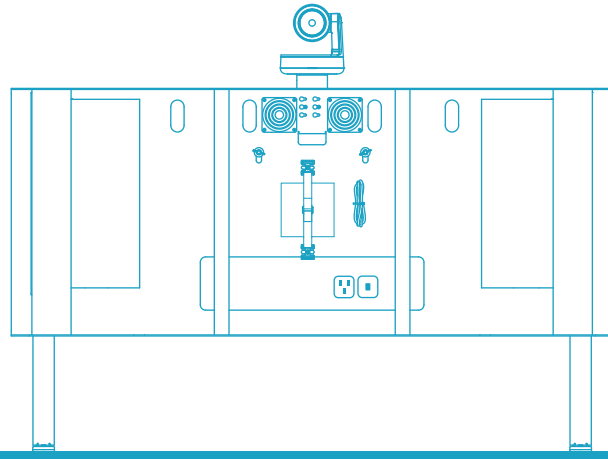

How to install the SNAPTOGGLE wall anchors.

Important note:

SNAPTOGGLE anchors are compatible for use with steel wall studs.

For more information go to Toggler.com.

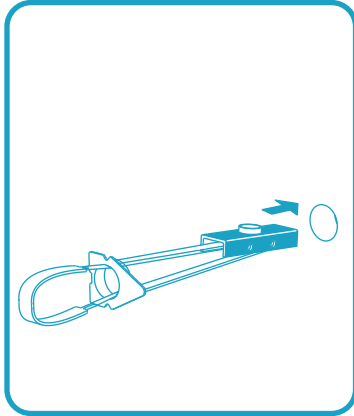

- 1** Drill a 3/4" hole. Hold metal channel flat alongside plastic straps, and slide channel through the hole. Minimum clearance behind wall: only 1/8".

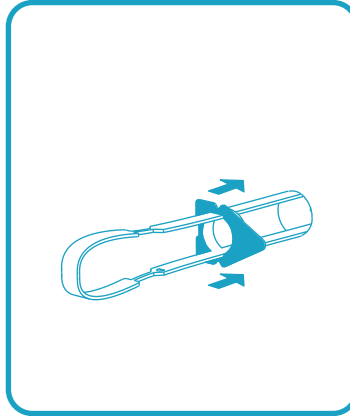

- 2** Hold ends of straps together between thumb & forefinger and pull toward you until channel rests behind wall. Ratchet cap along straps with other hand until flange of cap is flush with wall.

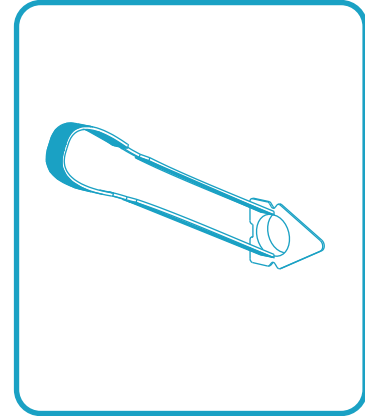

- 3** Place thumb between straps at wall. Push thumb side to side, snapping off straps level with flange of cap.

STEP 12

Install the dual display rails.

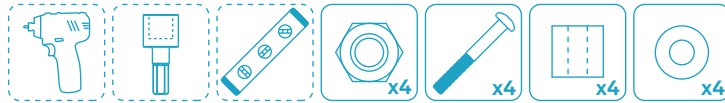

Fasten each dual display rail using the locknuts provided. Install spacers with screws and washers provided to the wall anchors.

Important note:
Install each rail with the notched side up.

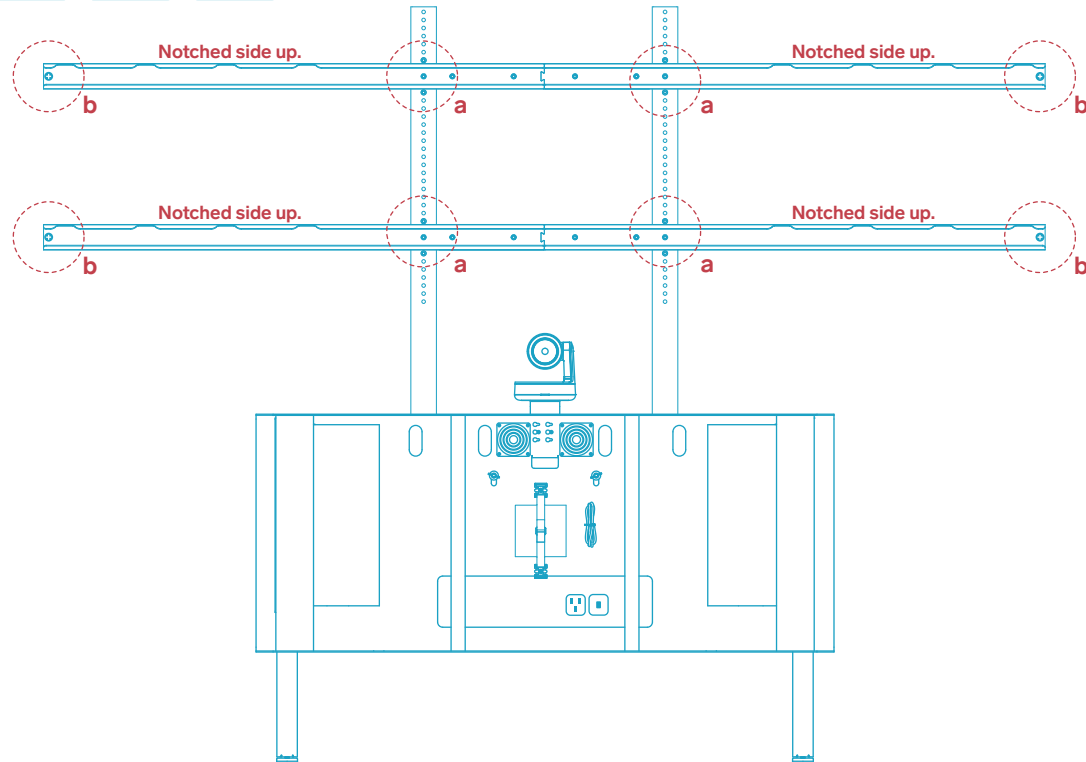
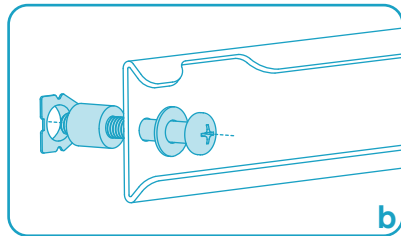
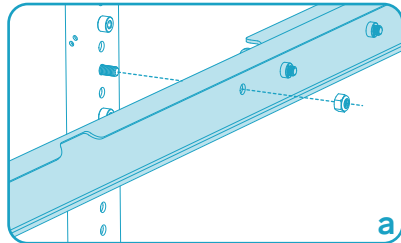

STEP 13

Install rolling display anchors to your displays.

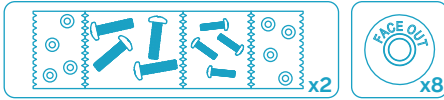

H570 Dual Display Kit includes one set of display-mounting screws and spacers. The second set is included with H544 Support Kit.

Important Notes:

The following steps should be performed by a professional.

Select the appropriate screw to fasten each rolling display anchor to your display. A set of potential screws are provided for your convenience. Refer to the display manufacturer's mounting requirements to select the correct screw size and length. This may require the purchase of alternate screws.

Fasten each rolling display anchor firmly - do not over tighten. The base of the anchor should be fixed to the display. The wheel part of the anchor should spin freely.

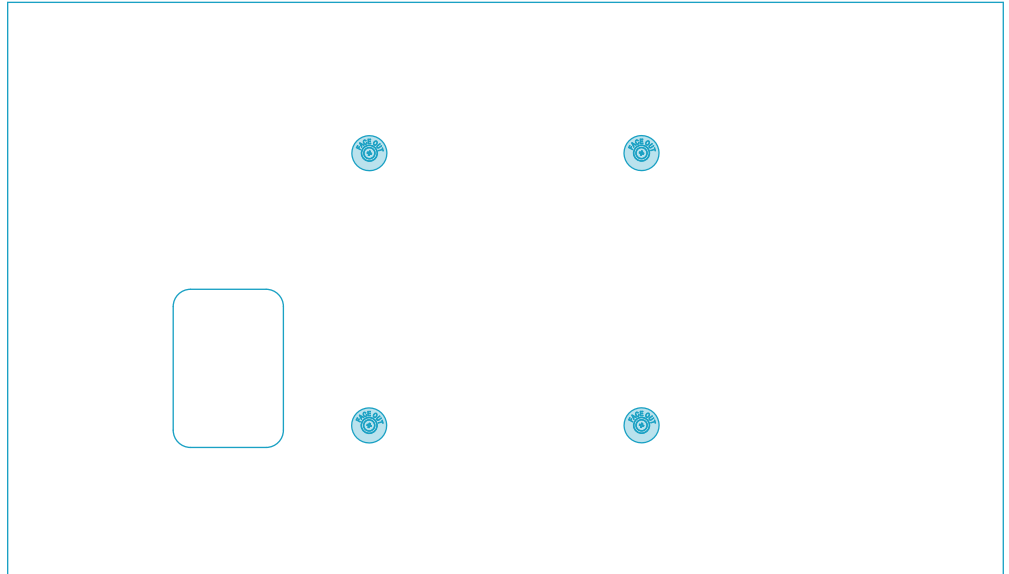
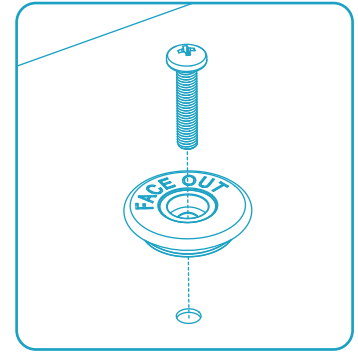

STEP 14

Extend cables and double check the cable length.

Before mounting each display, verify that you have ample power and HDMI cable length to reach their port locations and to easily connect these cables as you approach the display during mounting.

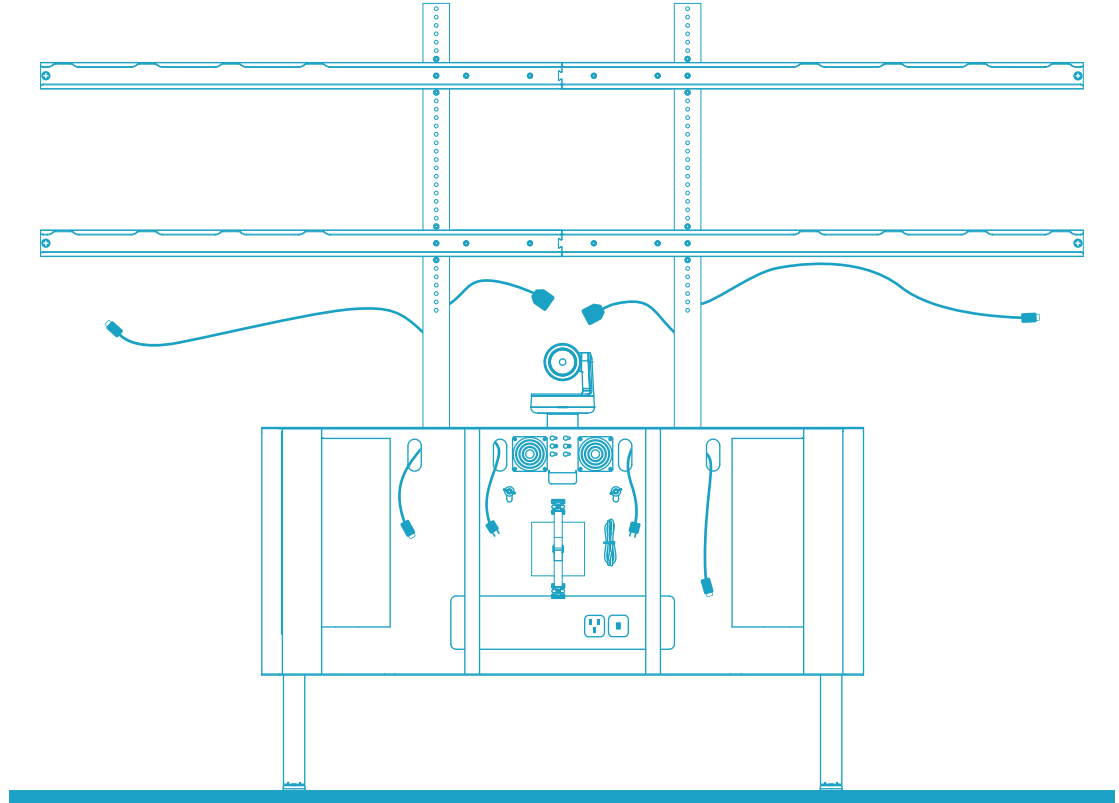

STEP 15

Bring the display close to the Credenza and plug in the cables.

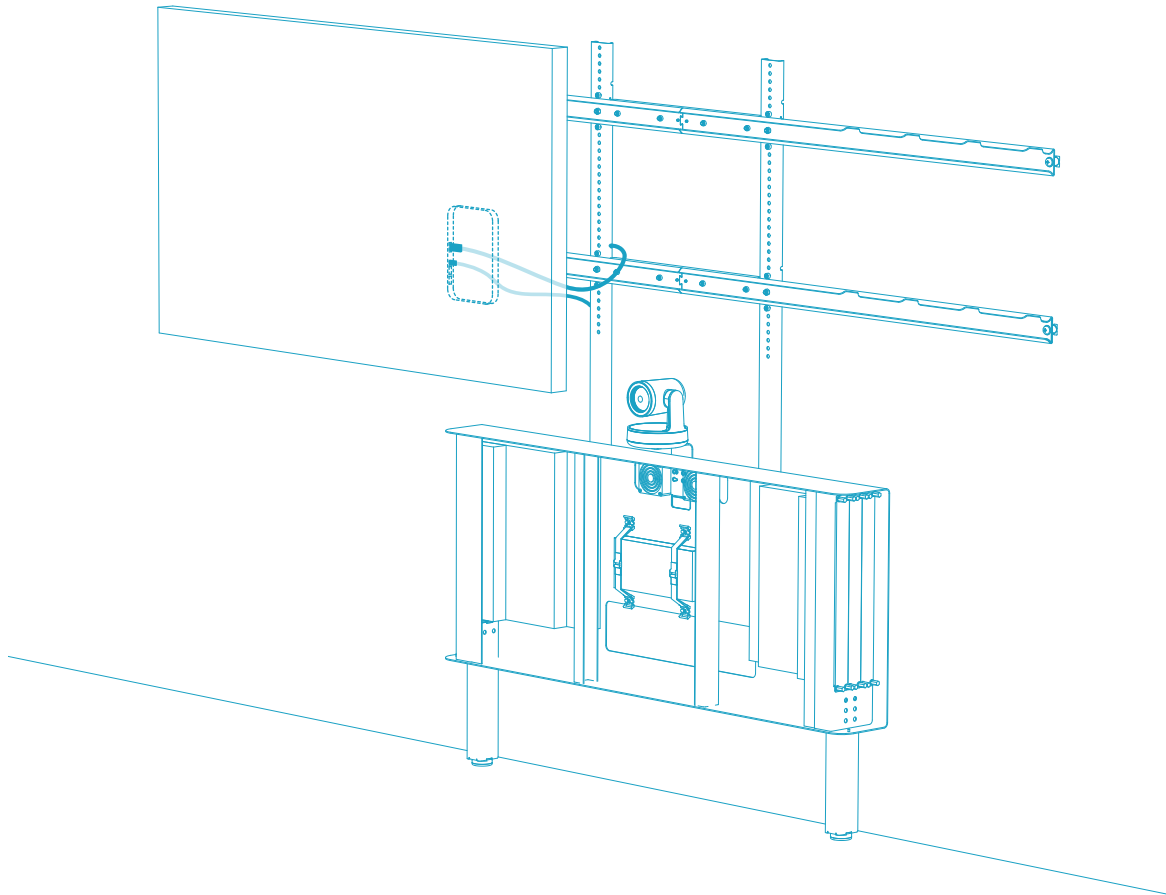

STEP 16

Mount the first display to the dual display rails.

- 1 Align the rolling display anchors with the notches on the display rails and gently set the display in place.

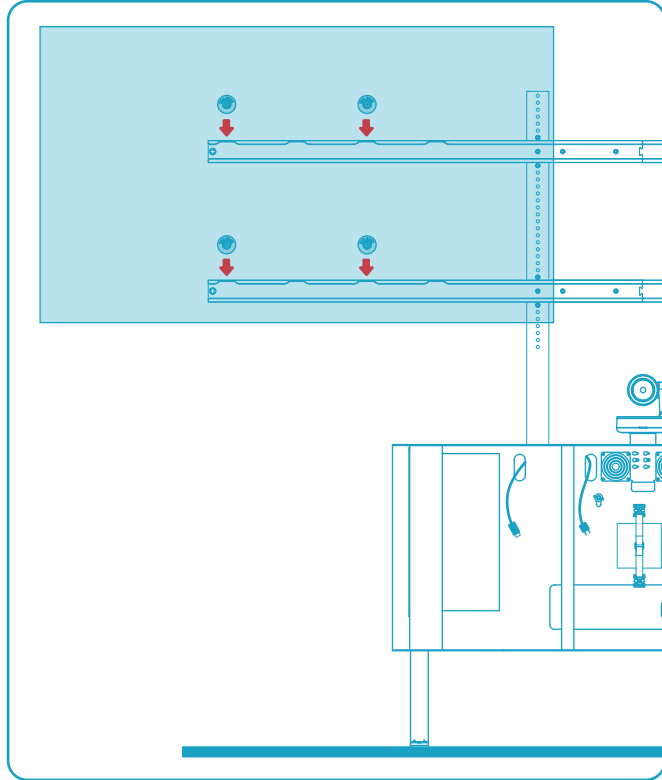

- 2 Confirm the rolling display anchors are seated in the rails.

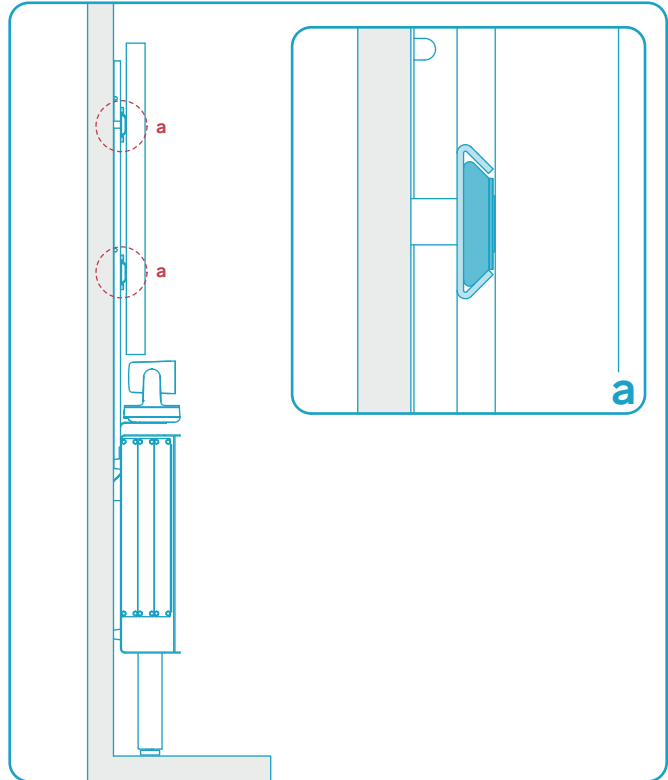

3 Roll the display toward its center position. This will lock the display to the rail.

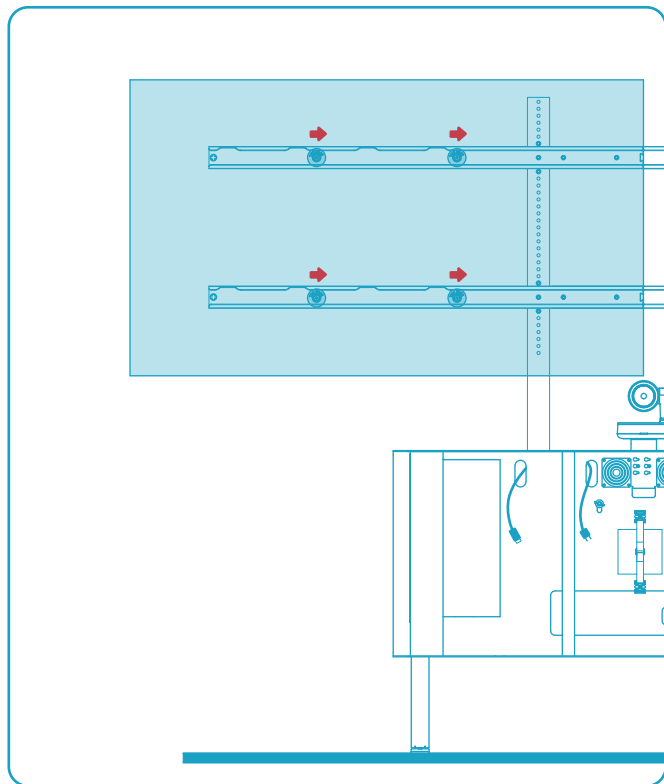

STEP 17

Repeat Step 16 to mount the second display.

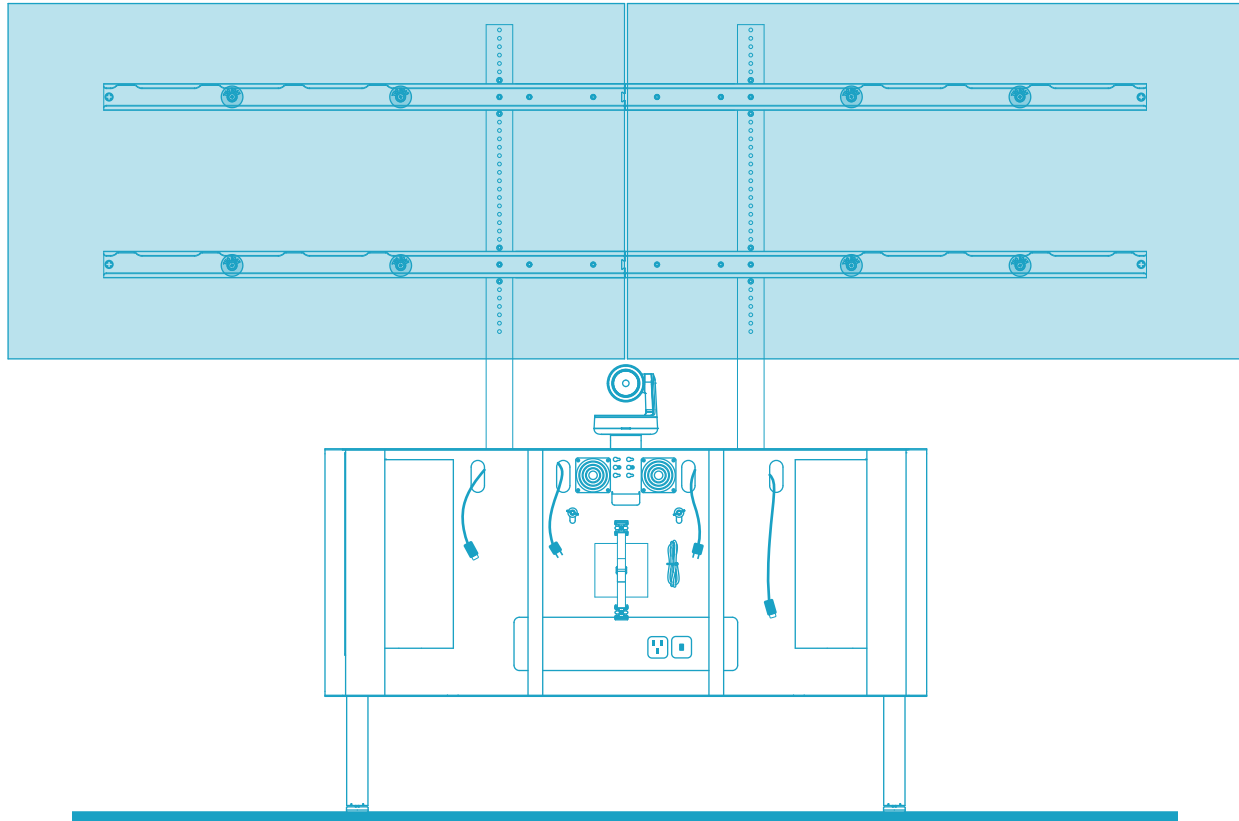

STEP 18

Attach the front cover.

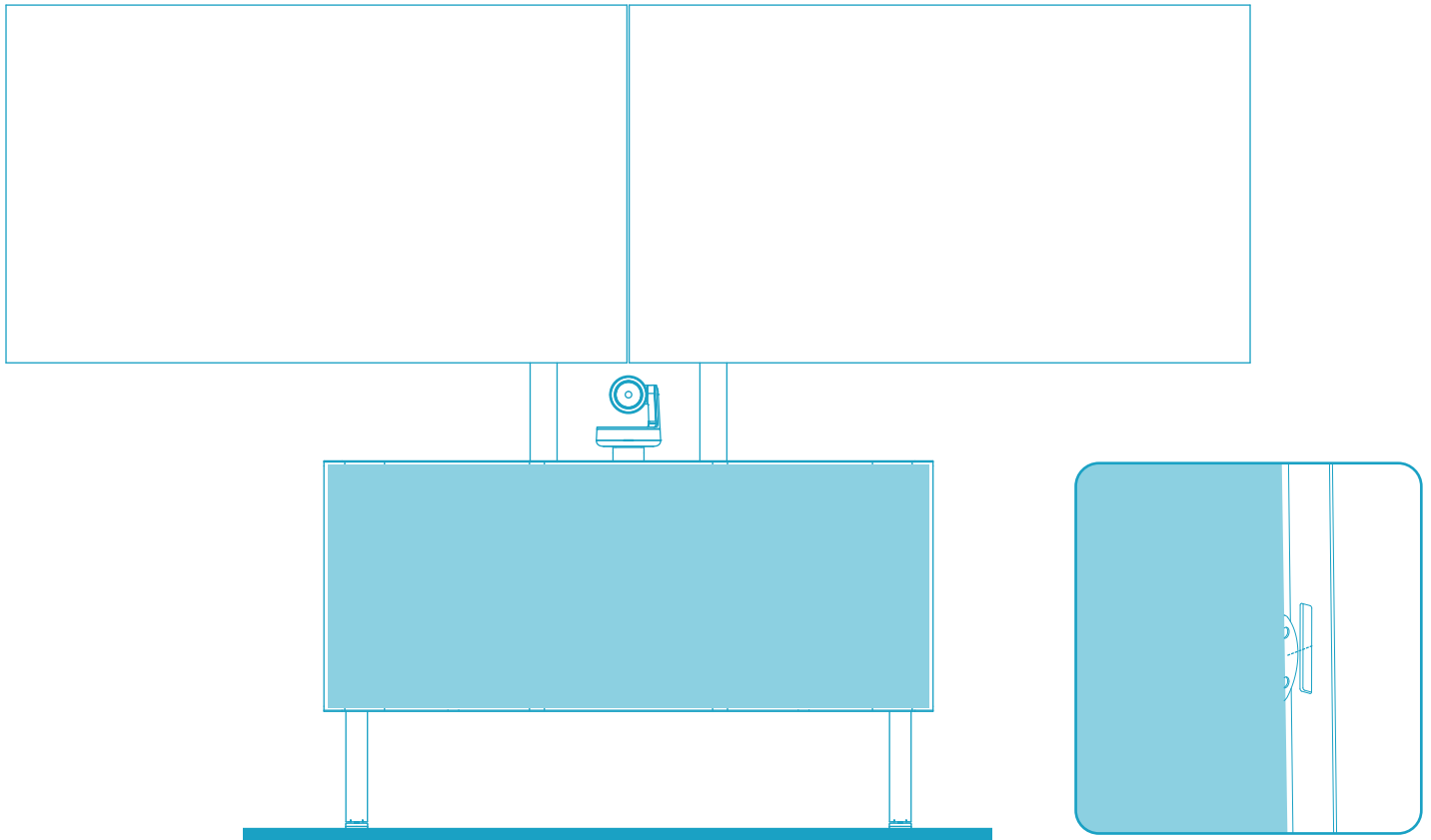

Tip 1: Remove the displays.

- 1 Roll the display all the way to the far end until the display rolling anchors meet the wall anchoring screws.

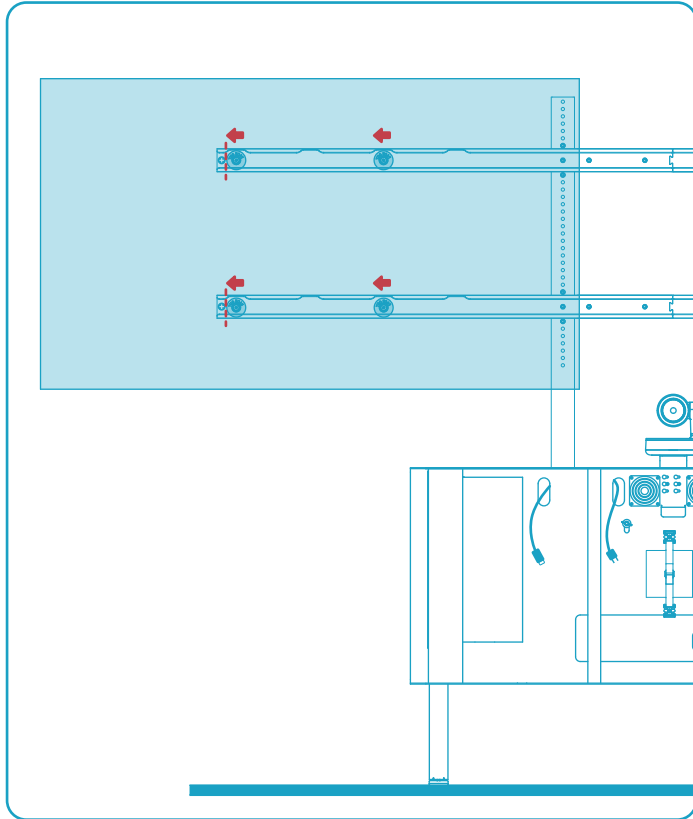

- 2 Lift the display and remove it from the dual display rails.

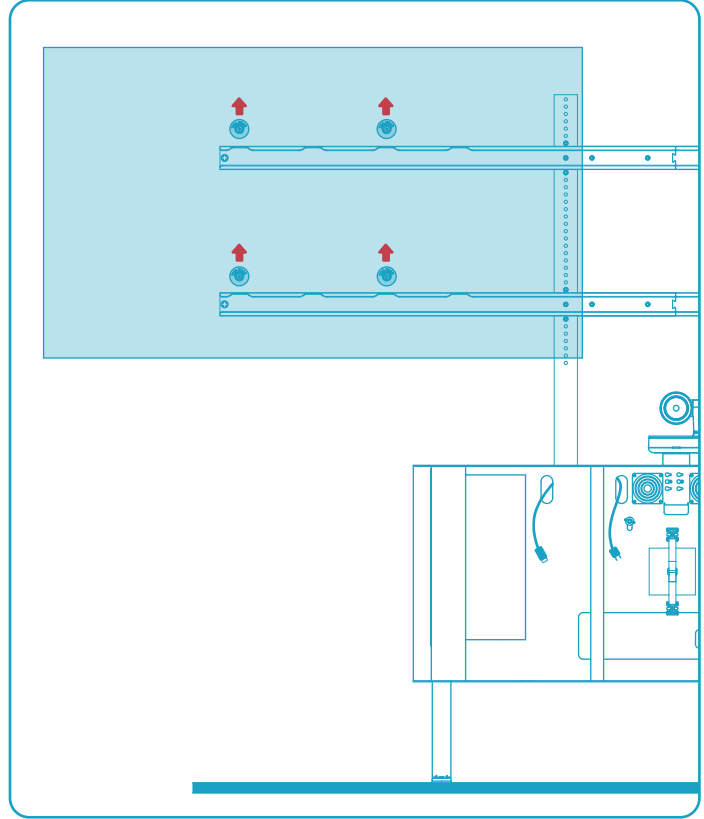

Tip 2: Roll both displays outward to access cables.

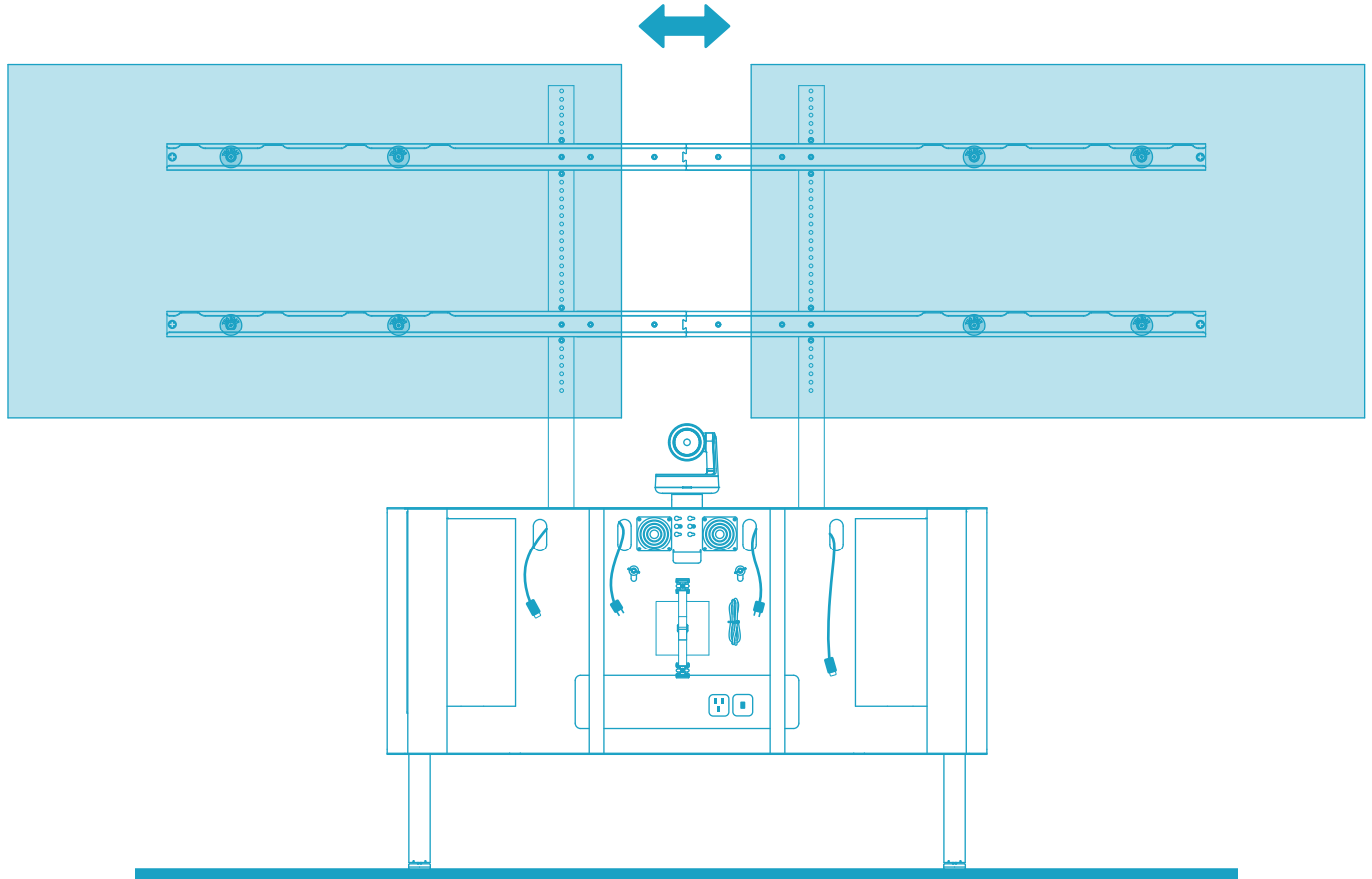

Tip 3: Align displays.

Gently push and pull the displays to create display alignment.

Each rolling display anchor features 1/8" of forward adjustment to help align the front face of both displays.

