

Instrucciones de instalación
Assembly instructions
Instructions de montage
Prescrizioni di montaggio

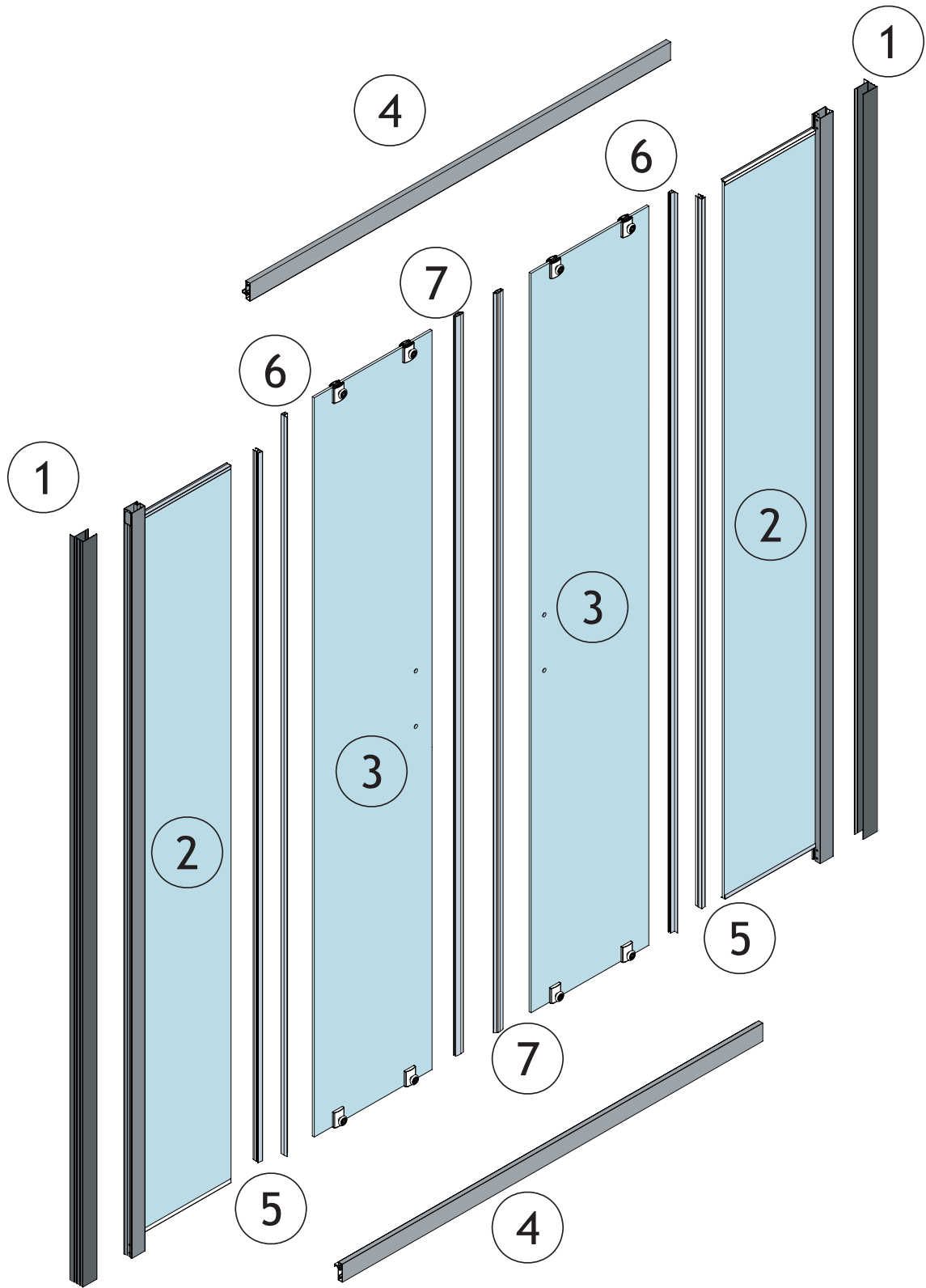

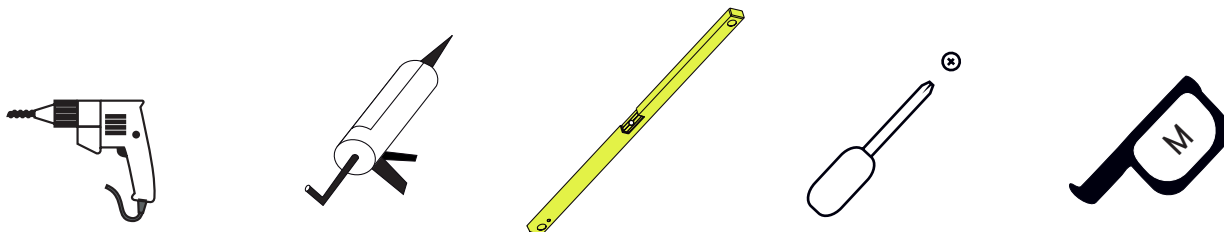









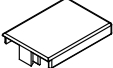

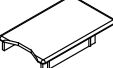
Herramientas / Tools / Outils / Strumenti di costruzione



Equipamiento / Features / Équipement / Capitolato

Ref.		Quant.	Ref.		Quant.
8.		2 Pc.	14.	 4x20	8 Pc.
9.		2 Pc.	15.	 4x12	8 Pc.
10.		2 Pc.	16.		10 Pc.
11.		4 Pc.	17.		10 Pc.
12.		6 Pc.	18.		1 Pc.
13.	 4x30	6 Pc.			

