

UWB-8

UNDERWATER JUNCTION BOX



Material: Brass
8-Way Connection: (1 for Power, 7 for Lights)
Available Finish: Brass

Overall Dimensions:
1.58"H x 5.50"W x 5.50"D

Weight: 3.6 lbs

Box Dimensions:
1.75"H x 5.75"W x 5.63"D

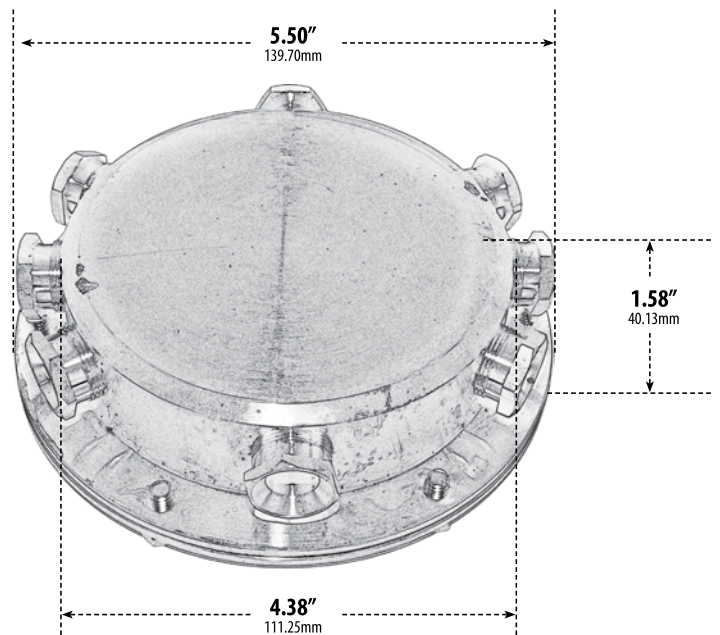

DABMAR
LIGHTING

DABMAR LIGHTING INCORPORATED

2140 Eastman Ave . Oxnard, CA 93030 . 805.604.9090 . f: 805.604.9050 . www.dabmar.com