

# LV-LED22-SS316/W

## RECESSED BRICK, STEP AND WALL LIGHT



- ▶ **Faceplate Material:** Marine Grade 316 Stainless Steel
- ▶ **Housing Material:** PVC
- ▶ **Lens:** Clear, Heat Resistant, Plastic
- ▶ **Lamp:** Integral LED Circuit Board

MODEL NUMBER	LAMP TYPE	ILLUMINANT TYPE	WATTS (W)	VOLTS (V)	LAMP(S) INCLUDED?
LV-LED22-SS316/W	LED BOARD	18 LEDs	1.5	12	YES

- ▶ **Available Finish:** Stainless Steel
- ▶ **Recessed Mount**
- ▶ **Connector Available:** P-CN01 (sold separately) See page 89
- ▶ **ETL Approval Pending**

Overall Dimensions:  
2.40"H x 5.75"W x 2.40D

Weight: 0.60 lbs  
Approximate Wire Length: 16"  
Box Dimensions: 2.50"H x 6.00"W x 2.63"D

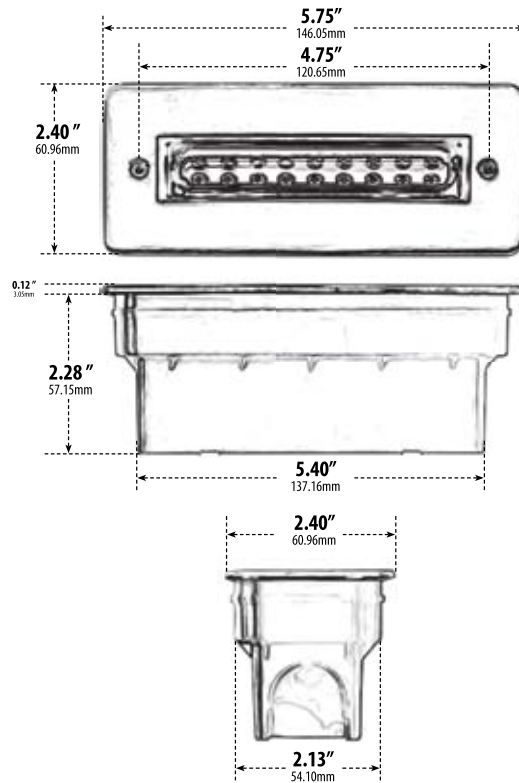

**DABMAR**  
LIGHTING

DABMAR LIGHTING INCORPORATED

2140 Eastman Ave . Oxnard, CA 93030 . 805.604.9090 . f: 805.604.9050 . www.dabmar.com