



BRENTWOOD HOME

BRENTWOOD BASE
OWNER'S MANUAL
Installation & Operation



Serial No.

CONTENTS

Safety & Warranty Warnings	1
Parts List	4
Electronics Quick Reference Guide	5
Installation Guide	7
Remote Control Instructions	9
Setting Programmable Positions and Pairing Remote	11
Setting Preset Positions	13
Synchronizing Two Bases	14
To Operate The Beds Separately Again	16
Troubleshooting	17

Safety & Warranty Warnings

Attention: Read the following information before using this product . Failure to use a surge protection device could compromise safety or cause product malfunction and could void the electrical portion of your warranty.

Electrical surges are by far the biggest cause of problems with electrical circuits.

In order to help protect your investment in case of a power surge or outage, use an electrical surge protection device (not included).

WARRANTY WARNING!

Do not open or tamper with the transformer, control box, motors, or remote control (with the exception of battery compartments). The product warranty will be void if these components are tampered with.

SMALL CHILDREN AND PETS:

Immediately dispose of all packing materials as they can smother small children and pets. Do not allow any persons or pets under the base. Children, convalescents and disabled person should not operate the base without adult supervision.

HOSPITAL OR CONVALESCENT USE DISCLAIMER:

Adjustable bases are designed and engineered for a lifestyle of in-home comfort and are not intended for hospital use or for a bed-ridden patient on an extended recovery. Adjustable bases are not equipped with bars to help patients get safely in and out of bed and are not intended to be used around tent type oxygen therapy or explosive gases.

PRODUCT RATINGS:

The base lift motors are not designed for continuous use of more than 2 minutes in an 18 minutes period, or approximately 10% duty cycle. Any attempt to circumvent or exceed this rating will shorten the life expectancy of the product and may void the warranty.

WEIGHT UNITS:

The limitation for this adjustable base is 850 lbs. The base will structurally support these weights, provided weight is evenly distributed across the head and foot sections. This product is not designed to support or lift this amount in the head or foot section alone. Exceeding this weight restriction could damage the base and/or cause injury and void the warranty. Enter or exit the base in a flat position and do not sit on the head or foot sections while in the raised position.

LIFTING AND LOWERING MECHANISMS AND MASSAGE UNITS:

It is normal for the raising and lowering feature on this base to emit a minimal humming sound during operation. The massage feature creates a vibrating hum during operation and the resonance will increase accordingly with a higher intensity motor setting.

LOCATION ENVIRONMENT:

The level of sound experienced in a room is directly related to the environment within that location. In a room with hardwood floors and the massage units turned on, a vibrating noise can be noticeable. To reduce the resonance, place a piece of carpet or rubber casters cups under the legs. The rubber caster cups also prevent the base sliding when located on smooth or hard surface flooring.

TO REDUCE THE RISK OF SHOCK, BURNS, FIRE OR INJURY:

Make sure the base is in a flat position and the vibrating motors are turned off before unplugging the base from the power source. Always unplug the base from the electrical outlet before cleaning or servicing the base . If the cord or plug is damaged, discontinue use of the base. Contact customer service for examination and repair.

FCC COMPLIANCE:

This device complies with part 15 of the FCC Rules for residential use. Operation is subject to the following two conditions: (1) This device may not cause harmful interference, and (2) this device must accept any interference received, including interference that may cause undesired operation.

Radio Frequency: 2.4 GHz

For customer service under this limited warranty.

Toll Free Phone:1.855.430.8943

Parts List

All electronics and components that need to be installed are located in boxes under the foundation or attached to the frame. Before discarding the packing materials, ensure that all the parts are accounted for.

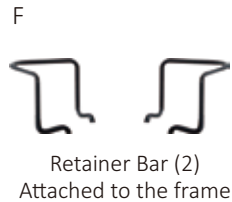
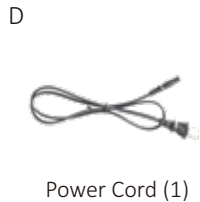
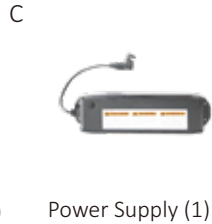
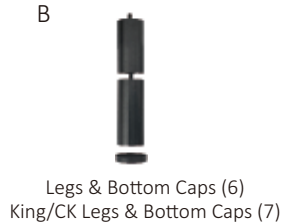
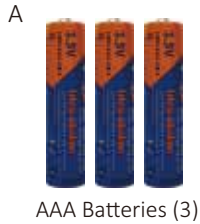

OPTIONAL EQUIPMENT (NOT INCLUDED)



Actual product appearance and functionality may vary from photographs.

Electronics Quick Reference Guide

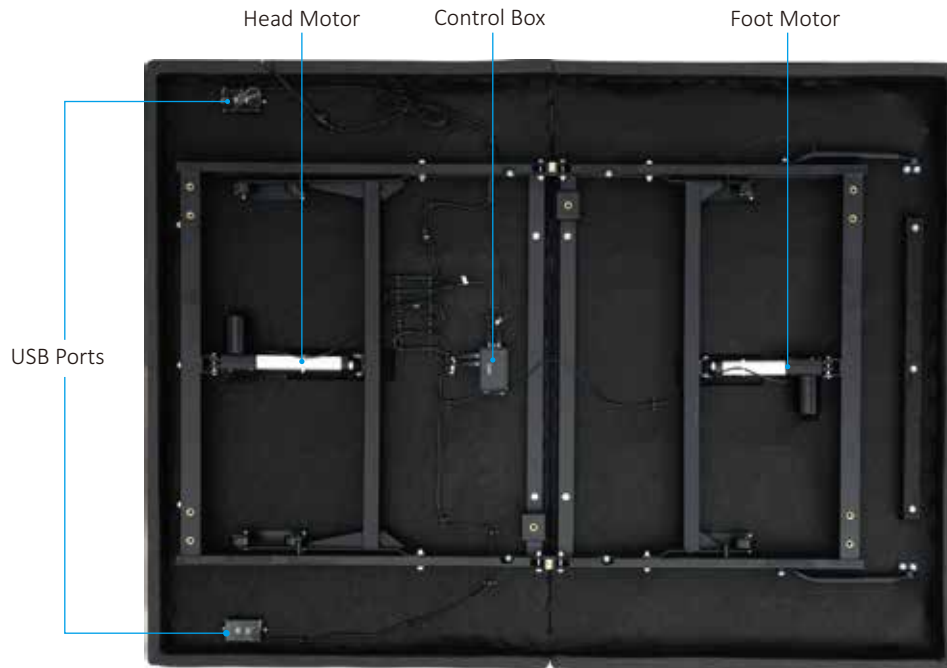

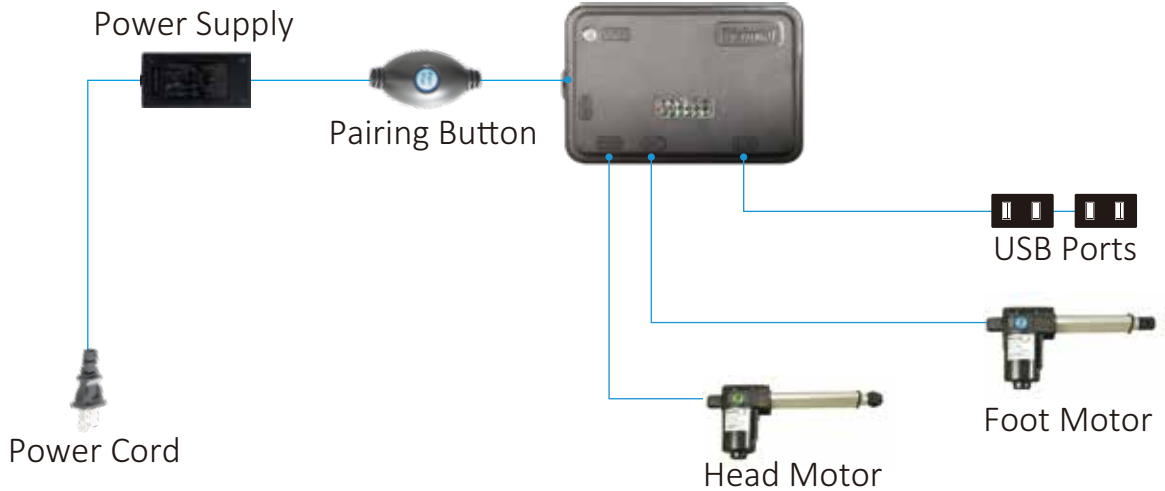

Installation Guide

Two people are required to set up the base.

NOTE: To avoid damage to the base, always open the carton in the flat position.

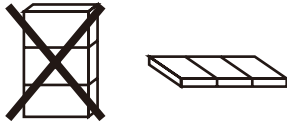

1. Open the shipping box, cut the ribbon securing accessory boxes & mattress retainer bars, and put them aside. Lift the folded base frame unit out of the shipping carton carefully, and then put it on a flat floor.



2. To install all six legs, thread the bolt of the leg to the nut on the base frame, and tighten by hand. **DO NOT OVERTIGHTEN.**



3. Uncoil the input power cord (connected to the control box's power port) and plug it into the power supply.



4. Uncoil the power cord and connect it to the power supply.



5. Carefully flip the base over onto its legs.

Important: Two people are required to move the base. Do not drag across the floor. Do not rest frame on its side; excessive pressure may damage the legs.

6. Ensure that batteries are correctly installed.



7. Insert the mattress retainer bars into the grommets as shown.



A

Head

Leg Positions

Foot

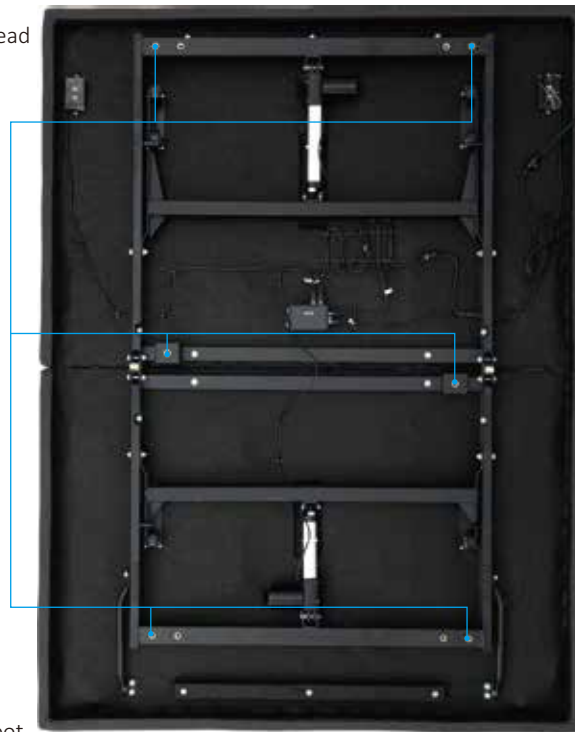

Remote Control Instructions

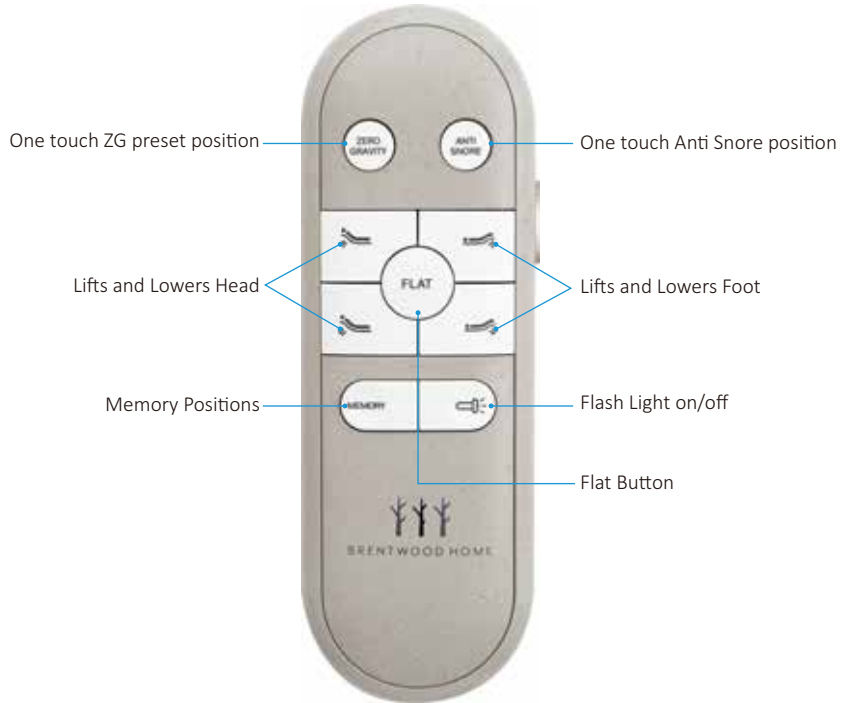

ADJUST



Lifts and Lowers Head



Lifts and Lowers Foot



Press and hold the button, flash light will be on.

ONE TOUCH BUTTONS



Anti Snore Preset Position



Zero-G Preset Position



Flat Button



Memory Positions

Setting Programmable Positions and Pairing Remote

SETTING PROGRAMMABLE POSITIONS

The adjustable base has a programmable feature that allows you to save custom positions. Please read all the instructions below before setting your custom presets on the remote.



STEP 1

Adjust the head and foot to your desired position.

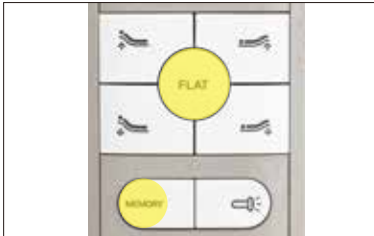

STEP 2

Press and hold the flat button **FLAT** first, then press and hold memory button **M** for 5 seconds until you hear 2 beeps sound.

STEP 3

To adjust the saved position, repeat steps 1 and 2 and the new position will be saved.

PAIRING REMOTE

The original remote that comes in the box is already paired to the base. No further action is required. In the event that the remote is not paired with the base, follow the steps below.



STEP 1

Make sure the batteries work fine. Replace them when needed.



STEP 2

Plug the power cord to the power source.

STEP 3

Press and hold head lift and foot lift simultaneously, then press and hold the button on the cord of control box for 3 seconds until you hear 2 beeps sound, the remote is then paired.



Setting Preset positions

SETTING PRESET POSITIONS

The adjustable base has a programmable feature that allows you to modify preset positions. Please read all the instructions below before setting your preset positions on the remote.



STEP 1

Adjust the head and foot to your desired position.



STEP 2

Press and hold the flat button **FLAT** first, then press and hold Anti Snore or Zero Gravity button for 5 seconds until you hear 2 beeps sound.

STEP 3

To adjust the saved position, repeat steps 1 and 2 and the new position will be saved.

STEP 4

If you want to restore to factory settings, unplug the power supply for 5 seconds, then plug back in. The base will restore to factory settings.

Synchronizing Two Bases

(for Twin XL and Split sizes only)

Pair Single Remote to Operate Two Bases Simultaneously

Step 1:

Ensure both bases (A and B) are plugged into a power source.



Step 2:

1. Make sure Remote A was already paired to Base A and Remote B was paired to Base B. If not, please pair them by following the pairing remote instructions on page 12.

2. On Remote A, press and hold Head Down and Foot Up at the same time, within 5 seconds, the Remote A backlit LEDs will blink. (Named Crossover)



3. Slide the side button to "L" position, then you can use Remote A to control Base A only.

4. If you slide the side button to "O" position, then you can also use Remote A to control Base A only.

5. Slide the side button to "R" position, then pair the Remote A to Base B, you can use Remote A to control Base B only.

If you want to use Remote A to control two bases simultaneously, slide the side button to "O" position.

Please note: If you want to control the bases through sliding the side button, only one remote can work. Another remote will not be workable.

So now you can not use Remote B to control Base B, you need to re-pair Remote B to Base B. Then if you want to use Remote B to control two bases, only follow the above steps 2-5 on Remote B.



Two remotes control two bases simultaneously.

On Remote B, press and hold Head Down and Foot Up at the same time, within 5 seconds, the Remote B backlit LEDs will blink. (Named Crossover)



For example:

1. If you want to use Remote A to control two bases, slide the side button to "O" position on Remote A.
2. If you want to use Remote A to control Base A only, slide the side button to "L" position on Remote A.
3. If you want to use Remote A to control Base B only, slide the side button to "R" position on Remote A.

The same steps for Remote B, if you want to use Remote B.

On Remote A, slide the side button to "L" position.

On Remote B, Press and Hold Head Down & Foot Down at the same time, within 5 seconds, the flashlight on Remote B will be on. Meanwhile press and hold Head Up & Foot Up on Remote A, then the flashlight on Remote B will blink. Now Remote B has learned Remote A successfully. Both remotes can control both bases simultaneously now.



Remote A



Remote B

To Operate The Beds Separately Again

Step 1:

On Remote A, press and hold the Head Down and Foot Up buttons simultaneously until the backlit LED lights blink. The Remote A now only controls Base A and the sync toggle no longer functions.

Step 2:

Next, on Remote B, press and hold the Head Down and Foot Up buttons simultaneously until the backlit LED lights blink.

Step 3:

On Remote B, press and hold the All Up and All Down buttons until the flashlight blinks.

Step 4:

Now, on Remote B, press and hold the Head Up and Foot Up buttons and the blue Pairing Button (located on the power cord) simultaneously until you hear a beep.

NOTE: Remote B now only controls Base B and the sync toggle no longer functions.

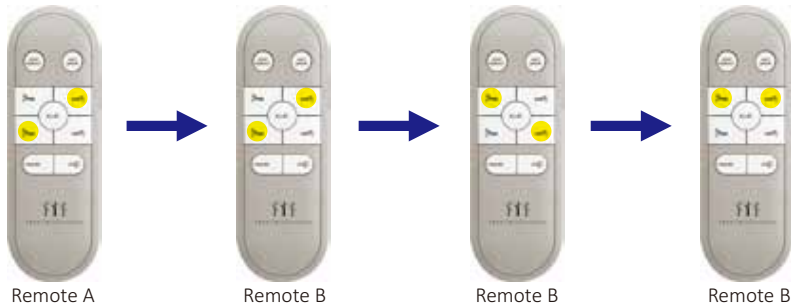

Troubleshooting

In the event that the base fails to operate, assess the symptoms and possible solutions provided in the chart below.

SYMPTOMS	SOLUTIONS
Remote control illuminates and appears to be operable, but will not activate base.	Verify that the power cord is plugged into a working, grounded electrical outlet. Test the outlet by plugging in another working appliance.
No features of the base will activate.	<p>Program the remote control (see the Setting Programmable Positions and Pairing Remote section of this manual for programming procedures).</p> <p>Unplug the power cord, wait 30 seconds and plug back to reset electronic components.</p> <p>The surge protection device or the electrical outlet may be defective. Test the outlet by plugging in another working appliance.</p> <p>Verify that the connector on the base is securely attached to the control box.</p>
Wireless remote will not illuminate.	Replace the batteries in the wireless remote.
Head or foot section will elevate, but will not return to the flat position.	<p>Base mechanism may be obstructed. Elevate base and check for obstruction. Remove obstruction.</p> <p>Head section may be too close to the wall.</p> <p>Headboard may be too close to the edge of the mattress. Verify that there is enough distance between the headboard brackets and mattress. Adjust if required.</p>

Troubleshooting

SYMPTOMS	SOLUTIONS
Head & Foot lift function has minor interference during operation.	<p>Check batteries in wireless remote control, replace with two (2) new AAA batteries if necessary.</p> <p>Make sure that you are following the duty cycle of the motors (do not operate more than two minutes over a 18-minute period, or approximately 10% duty cycle).</p> <p>Press the lift buttons squarely and accurately.</p> <p>Wireless remote control may be experiencing common Radio Frequency Interference from other radio transmitting devices. Wait several seconds, and then try pressing appropriate button again. See FCC Compliance Statement on page 5 of this guide.</p>
Excessive massage motor noise.	<p>If the base is located on hard surface flooring, place carpet pieces or rubber casters cups (not included) under each leg.</p> <p>Using the wireless remote control, elevate the head or foot section a short distance to realign the mechanisms with the base support platform.</p> <p>Verify that your base is not positioned against a wall, nightstand, or other object that may cause the vibration or noise.</p> <p>If the base is installed over a bed frame, verify that the massage motors are not causing the base frame (or base frame components) to vibrate.</p> <p>Verify that the headboard attachment hardware is properly tightened (if used).</p>

Troubleshooting

SYMPTOMS	SOLUTIONS
A clicking noise is heard under the base when raising or lowering.	This is normal. The lift motor relays “click” when they are engaged. No action is required.
Massage motor overheats or stops.	If the vibration motor overheats, the thermal protection will turn the motor off. Wait 30 minutes, turn the massage back on. If it does not come on, turn it off and report the situation to customer service.



BRENTWOOD HOME