

DeltaTM

Children's Products

VANITY & STOOL

Assembly Instructions

LA VANITE ET LE TABOURET

Instructions d'assemblage

TOCADOR Y TABURETE

Instrucciones de Ensamblaje

Aufbauanleitung

Instruções de Montagem

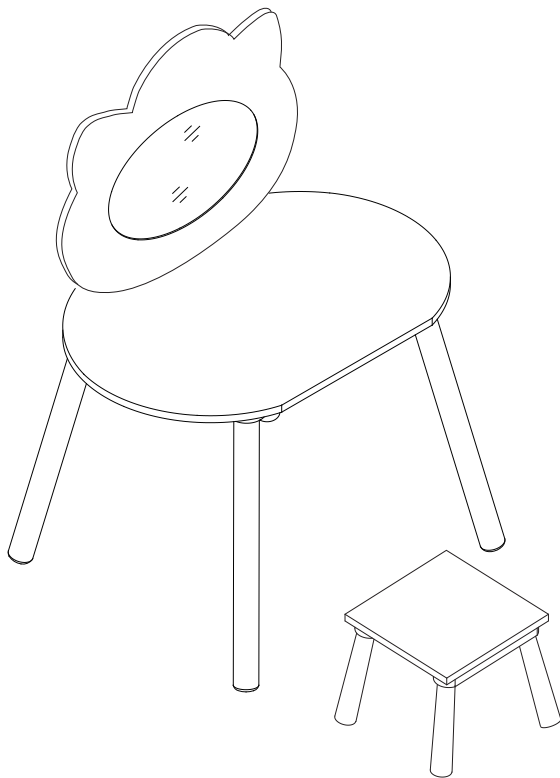

Read all instructions before assembly and use.
KEEP INSTRUCTIONS FOR FUTURE USE.

▲ ADULT ASSEMBLY REQUIRED

Due to the presence of small parts during assembly, keep out of reach of children until assembly is complete.

Lisez toutes les instructions avant l'assemblage et l'utilisation. **CONSERVEZ LES INSTRUCTIONS POUR UN USAGE ULTERIEUR.**

▲ L'ASSEMBLAGE DOIT ETRE FAIT PAR UN ADULTE

A cause de la presence de petites pieces, pendant l'assemblage gardez hors de portee des enfants jusqu'a ce que celui-ci soit termine.

Lea todas las instrucciones antes de ensamblar y usar. **MANTENGA LAS INSTRUCCIONES PARA SU USO FUTURO.**

▲ DEBE SER ENSAMBLADO POR UN ADULTO

Debido a la presencia de piezas pequeñas durante el ensamblaje, mantenga fuera del alcance de los niños hasta que complete el ensamblaje.

Lesen Sie die Instruktionen vor dem Zusammenbauen und Benutzung. **Bewahren Sie die Instruktionen für spätere Benutzung auf.**

▲ **DIE MONTAGE DARF NUR VON ERWACHSENE AUSGEFÜHRT WERDEN.** Aufgrund den vielen kleinen Einzelteilen sind Kinder während des Zusammenbauens fernzuhalten.

Leia todas as instruções antes da montagem e uso. **MANTENHA AS INSTRUÇÕES PARA SEU USO FUTURO.**

▲ MONTAGEM POR ADULTO FAZ-SE NECESSARIA

Devido à presença de pequenas peças durante a montagem, manter fora do alcance de crianças até que a montagem esteja completa.

Consumer Care:

www.DeltaChildren.com
Delta Children's Products
114 West 26th Street
New York, NY 10001
Tele.212-645-9033

When contacting Delta Consumer Care, please reference the information on the Product Information label found on the product.

Lorsque vous contactez le Service après Vente de Delta, veuillez donner les références sur l'étiquette d'Information qui se trouve sur le produit.

Cuando contacte al Servicio de Atención al Consumidor de Delta por favor mencione los datos que aparecen en la etiqueta de información que se encuentra en el producto.

Wenn Sie den Kundenservice von Delta kontaktieren, beziehen Sie sich bitte auf die Information auf der Etikette des Produktes.

Ao entrar em contato com o Atendimento ao Consumidor da Delta, por favor mencione as informações encontradas na etiqueta de informações do produto.

Parts, Pièces, Piezas, Teile, Peças

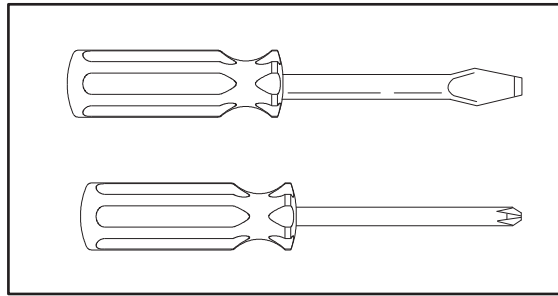
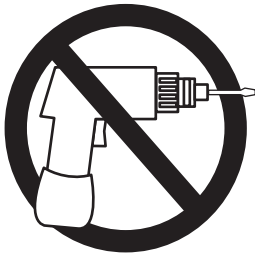

2 x
AA

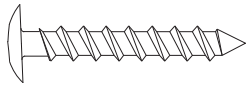

1 x
A

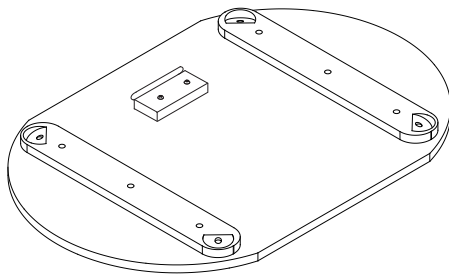

1 x
B

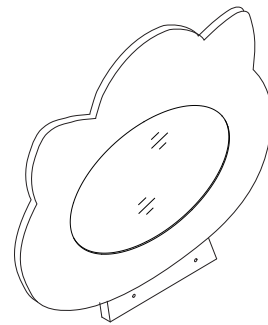

4 x
C

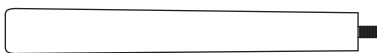

4 x
D



1 x
E

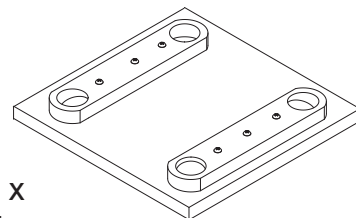

1

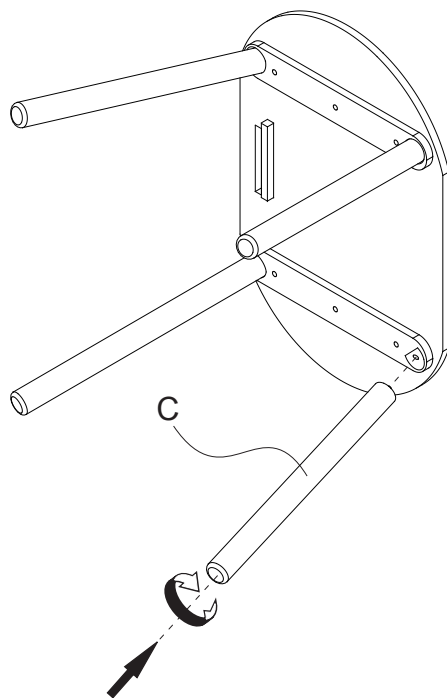

2

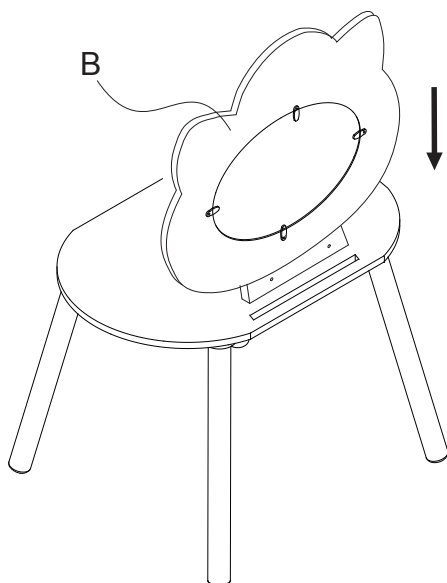

3

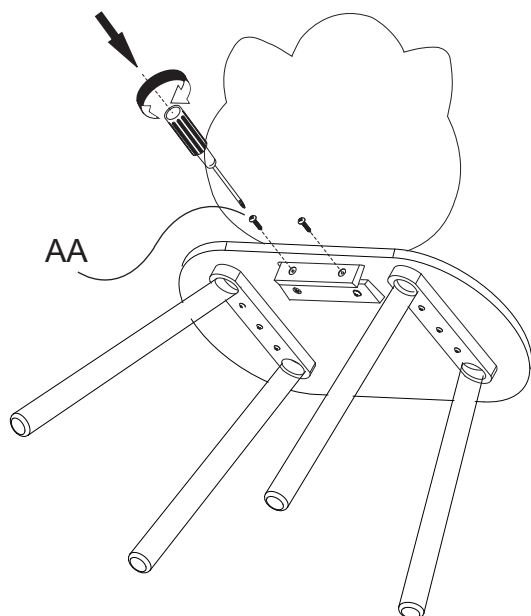

4

