

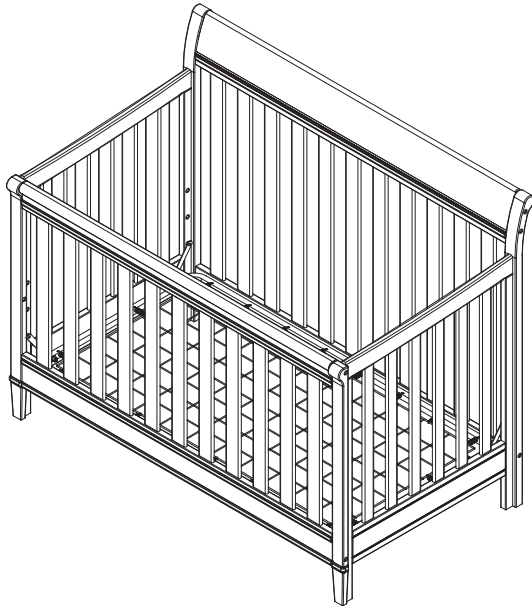

Read all instructions before assembly and use.
KEEP INSTRUCTIONS FOR FUTURE USE.

⚠ ADULT ASSEMBLY REQUIRED
Due to the presence of small parts during assembly, keep out of reach of children until assembly is complete.

4 in 1 Crib



**THIS PRODUCT IS NOT INTENDED FOR
INSTITUTIONAL OR COMMERCIAL USE.**



Consumer Care:
www.DeltaChildren.com
Delta Children's Products
114 West 26th Street
New York, NY 10001
Tele. 212-645-9033

Style #: _____
Lot: _____
Date: _____



When contacting Delta Consumer Care please reference the above information. Before contacting Delta Consumer Care please ensure that the information above matches the information found on the label on the Crib End bottom rail, please reference the information found on the product when contacting Delta Consumer Care.

To register your product for important safety alerts and updates to your product please visit www.DeltaChildren.com and click on Product Registration.

CAUTION:

ANY MATTRESS USED IN THIS CRIB SHALL BE AT LEAST 27 1/4 BY 51 5/8 IN. WITH A THICKNESS NOT EXCEEDING 6 IN.

WARNING:

*Infants can suffocate on soft bedding. Never add a pillow or comforter. Never place additional padding under an infant.

*Failure to follow these warnings and the assembly instructions could result in serious injury or death. DO NOT use this crib if you cannot exactly follow the accompanying instructions.

*To reduce the risk of SIDS, pediatricians recommend healthy infants be placed on their backs to sleep, unless otherwise advised by your physician.

***Strangulation Hazard:** STRINGS CAN CAUSE STRANGULATION! Do not place items with a string around a child's neck, such as hood strings or pacifier cords. Do not suspend strings over a crib or attach strings to toys.

***Strangulation Hazard:** To help prevent strangulation tighten all fasteners. A child can trap parts of the body or clothing on loose fasteners.

***Strangulation Hazard:** Do not place crib near window or patio door where cords from blinds or drapes may strangle a child.

***Fall Hazard:** When child is able to pull to a standing position, set mattress to lowest position and remove bumper pads, large toys and other objects that could serve as steps for climbing out. This crib has an adjustable mattress support. For the convenience of the parent when the baby is very small, the mattress support may be used in the highest position. Important: with the mattress support and mattress in the highest position, be absolutely sure that the top of the front crib side is at least 3 inches higher than the top surface of the mattress. If it is not, lower the mattress support and the mattress to the next highest position.

***Fall Hazard:** Stop using crib when child begins to climb out or reaches a height of 35in. (89cm), whichever occurs first. The child should be placed in a youth or regular bed.

*Check this product for damaged hardware, loose joints, loose bolts or other fasteners, missing parts, or sharp edges before and after assembly and frequently during use. Securely tighten loose bolts and other fasteners. Do not use crib if any parts are missing, damaged or broken. Contact Delta Children's Products for replacement parts and instructional literature if needed. Do not substitute parts.

*Follow warnings on all products in a crib.

*If refinishing, use a non-toxic finish specified for children's products.

***Never** use plastic shipping bags or other plastic film as mattress covers because they can cause suffocation.

*Infants can suffocate in gaps between crib sides and a mattress that is too small.

*Ensure a safe environment for the child by checking regularly, before placing the child in the crib, that every component is properly and securely in place.

*To avoid head injury, do not allow any child to play underneath the crib.

***Never** add an accessory such as a bassinet or changing table that extends over the sleeping area.

***In Canada Only** - Use a crib mattress that is no thicker than 15 cm and is of such a size that, when it is pushed firmly against any side of the crib, it does not leave a gap of more than 3 cm between the mattress and any part of the sides of the crib. Do not use this crib for a child who can climb out of it or who is taller than 90 cm.

TODDLER BED

⚠WARNING

INFANTS HAVE DIED IN TODDLER BEDS FROM ENTRAPMENT.

Openings in and between bed parts can entrap head and neck of a small child.
NEVER use bed with children younger than 15 months.
ALWAYS follow assembly instructions.
The maximum user weight is 50lbs (22.7kg)

⚠WARNING

STRANGULATION HAZARD

NEVER place bed near windows where cords from blinds or drapes may strangle a child.
NEVER suspend strings over a bed.
NEVER place items with a string, cord, or ribbon, such as hood strings or pacifier cords, around a child's neck. These items may catch on bed parts.

⚠CAUTION

ENTRAPMENT HAZARD

To avoid dangerous gaps, any mattress used in this bed shall be a full-size crib mattress at least 51 5/8 in (1310mm) in length, 27 1/4 in (690mm) in width and 4 in (100mm) in thickness. The mattress thickness must not exceed 6 in (150mm).

NOTES ON ASSEMBLY:

- During the assembly process whenever using screws or bolts, check each by placing the screw/bolt on the diagram of the item which is drawn actual size and design. Be sure to use the proper size and shape specified in the instructions.
- To assemble this unit you may be required to place the unit on it's side and face. It is strongly recommended that assembly is done on a soft, non-abrasive surface to avoid damaging the finish.

NOTES ON USE:

Keep children and others safe by following these simple rules:

- **Do not** allow any child to play on furniture
- **Do not** allow climbing on any piece of furniture.
- **Do not** allow hanging from any piece of furniture.
- Always monitor your child's activity when in the nursery.

NOTES ON CARE AND MAINTENANCE:

- **Do not** scratch or chip the finish.
- Inspect the product periodically, contact Delta Children's Products for replacement parts or questions.
- **Do not** store the product or any parts in extreme temperatures and conditions such as a hot attic or a damp, cold basement. These extremes can cause a loss of structural integrity.
- To preserve the luster of the high quality finish on your product, it is recommended to place a doily or felt pad under any items you place on the finish.
- Clean with a damp cloth, then a dry cloth to preserve the original luster and beauty of this fine finish.
- Do not** use abrasive chemicals.
- Do not** spray cleaners directly onto furniture.
- Lift slightly when moving on carpeting to prevent leg breakage.
- Use of a vaporizer near furniture will cause wood to swell and finish to peel.

PARTS: MAKE SURE THAT ALL PRE-ASSEMBLED PARTS ARE TIGHT.

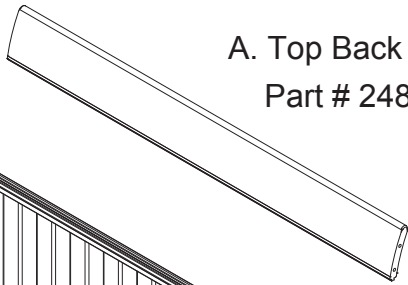

A. Top Back Rail x 1
Part # 24825

G. Right Back Post x 1
Part # 24831

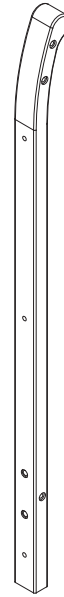

J. Right Front Post x 1
Part # 24833

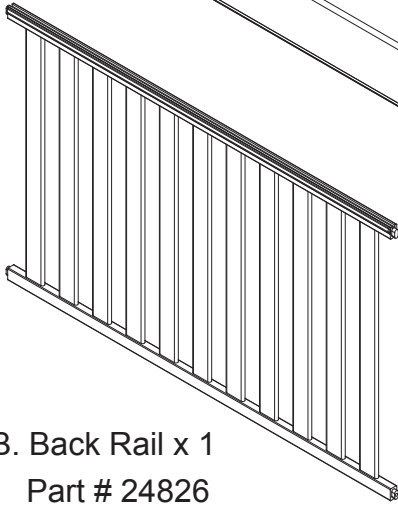

B. Back Rail x 1
Part # 24826

F. Left Back Post x 1
Part # 24830

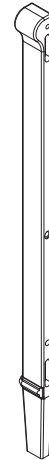
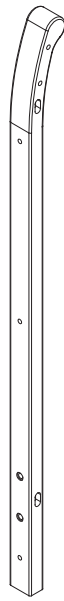

H. Left Front Post x 1
Part # 24832

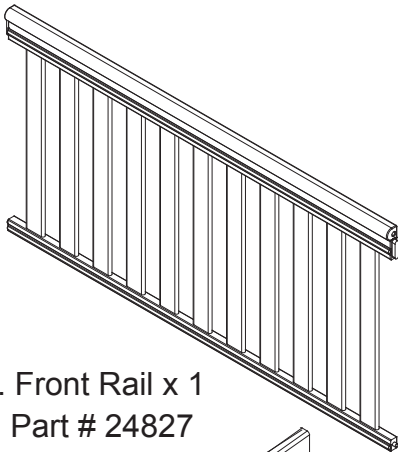

C. Front Rail x 1
Part # 24827

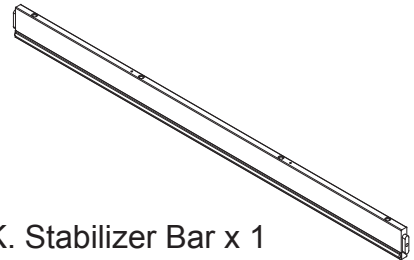

K. Stabilizer Bar x 1
Part # 24834

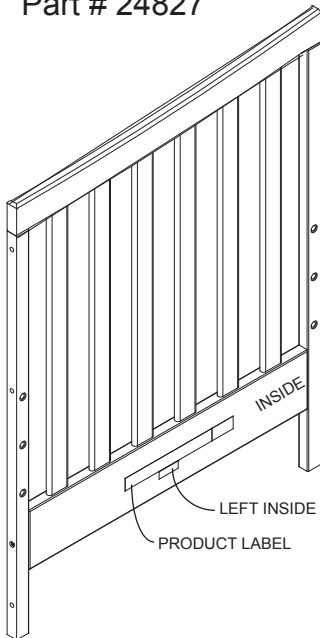

D. Left Crib Side x 1
Part # 24828

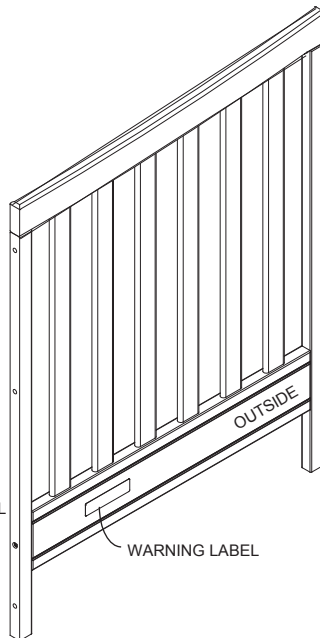

E. Right Crib Side x 1
Part # 24829

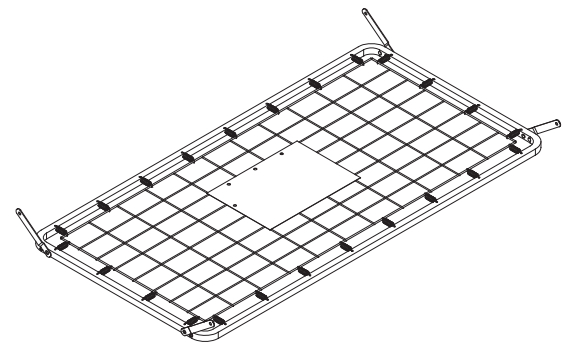

L. Mattress Support x 1
Part # 24225

POUCH ATTACHED TO MATTRESS SUPPORT
- KEEP INSTRUCTIONS IN THIS POUCH
AFTER ASSEMBLY.
WARNINGS RELATED TO THE SAFE USE OF
THIS CRIB ARE PRINTED ON THE POUCH.

PARTS: HARDWARE KIT IS PART #24835-986 FOR COLOR 108 OR #24835-988 FOR COLOR 207 AND 208. SEE FRONT COVER.

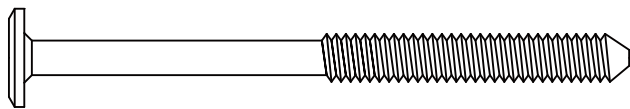
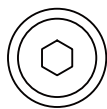

M. M6 x 80 mm Bolt x 8
Part # 5473

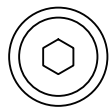

N. M6 x 60 mm Bolt x 2
Part # 5469

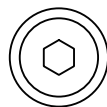

P. M6 x 40 mm Bolt x 12
Part # 5465

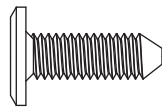
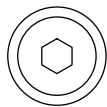

R. M6 x 18 mm Bolt x 8
Part # 5763

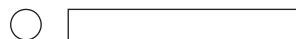

S. Φ 4x30 mm Metal Pin x 2
Part # 5493

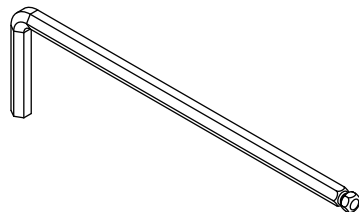

M4 Allen Wrench Supplied
Part # 1177

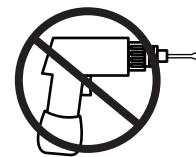

No drills necessary.
Do not use power
screwdriver.



Flat Head Screwdriver
(not supplied)

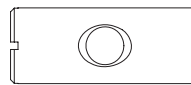

T. 10mm x17mm Barrel Nut x 8
Part # 5479

Section 1: Crib Assembly

Step 1

Parts and tools required to complete step.

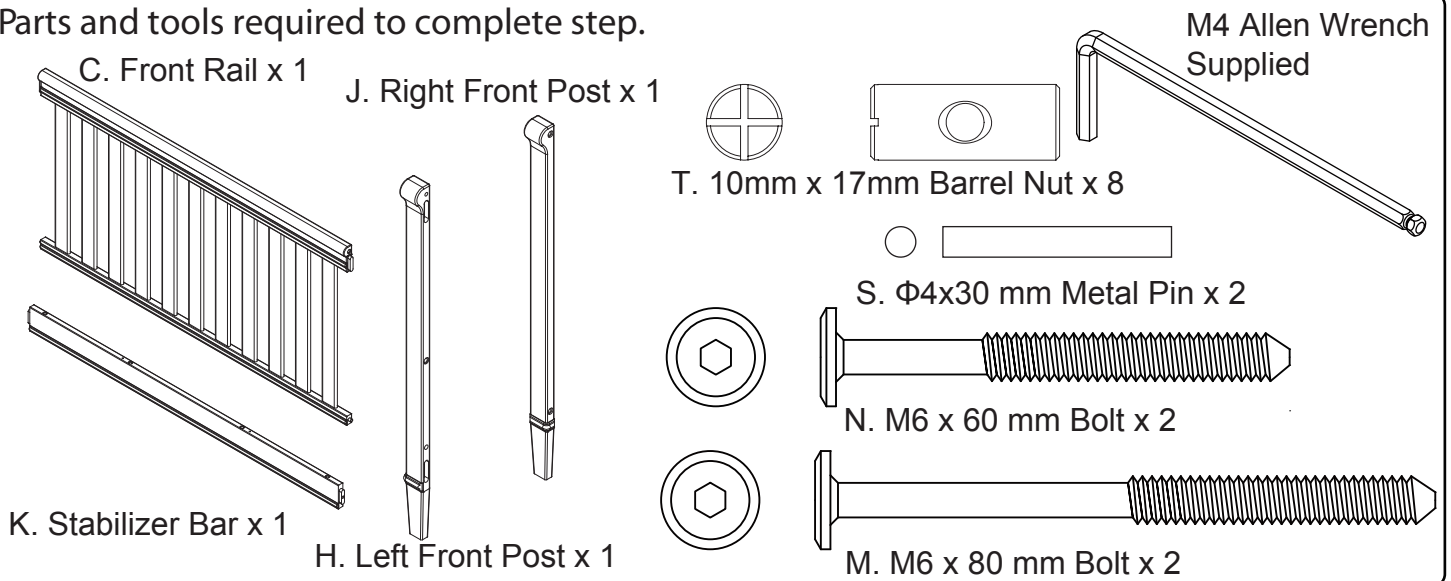

Attach (1) Left Front Post (Part H) and (1) Right Front Post (Part J) to (1) Front Rail (Part C) and (1) Stabilizer Bar (Part K) using (2) $\Phi 4 \times 30$ mm Metal Pins (Part S), (2) M6 x 80 mm Bolts (Part M), (2) M6 x 60 mm Bolts (Part N) and (2) 10mm x 17mm Barrel Nut (Part T). Tighten with the M4 Allen Wrench. Use the Flat Head Screwdriver to hold the Barrel Nut in the proper alignment.

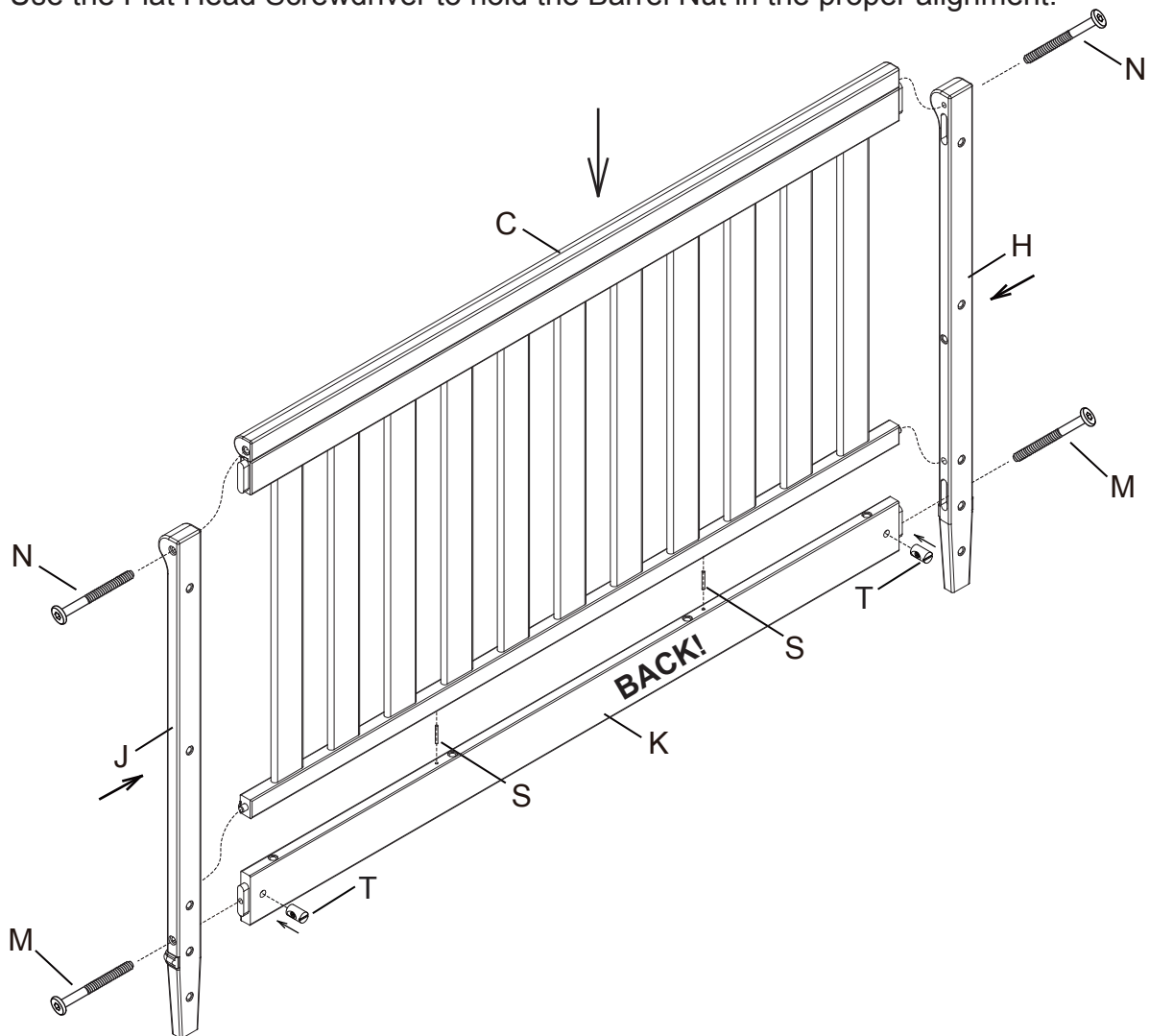

Section 1: Crib Assembly

Step 2

Parts and tools required to complete step.

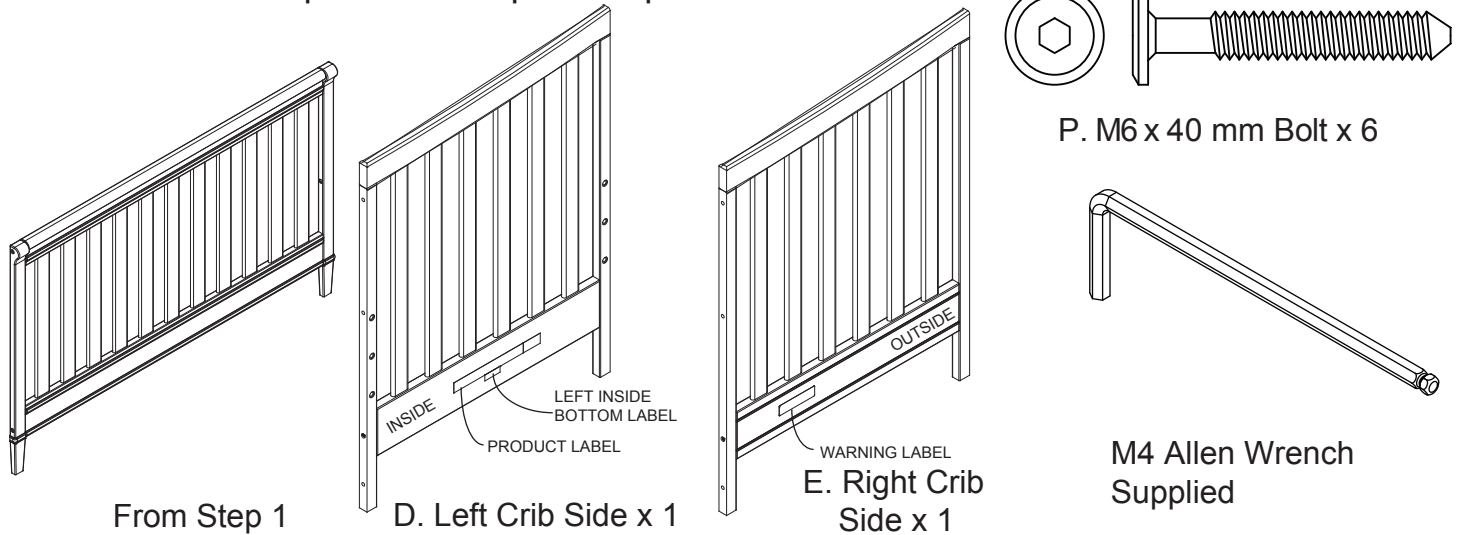

Attach (1) Left Crib Side (Part D) and (1) Right Crib Side (Part E) to the assembly from step 1 using (6) M6 x40 mm Bolts (Part P). Tighten with the M4 Allen Wrench.

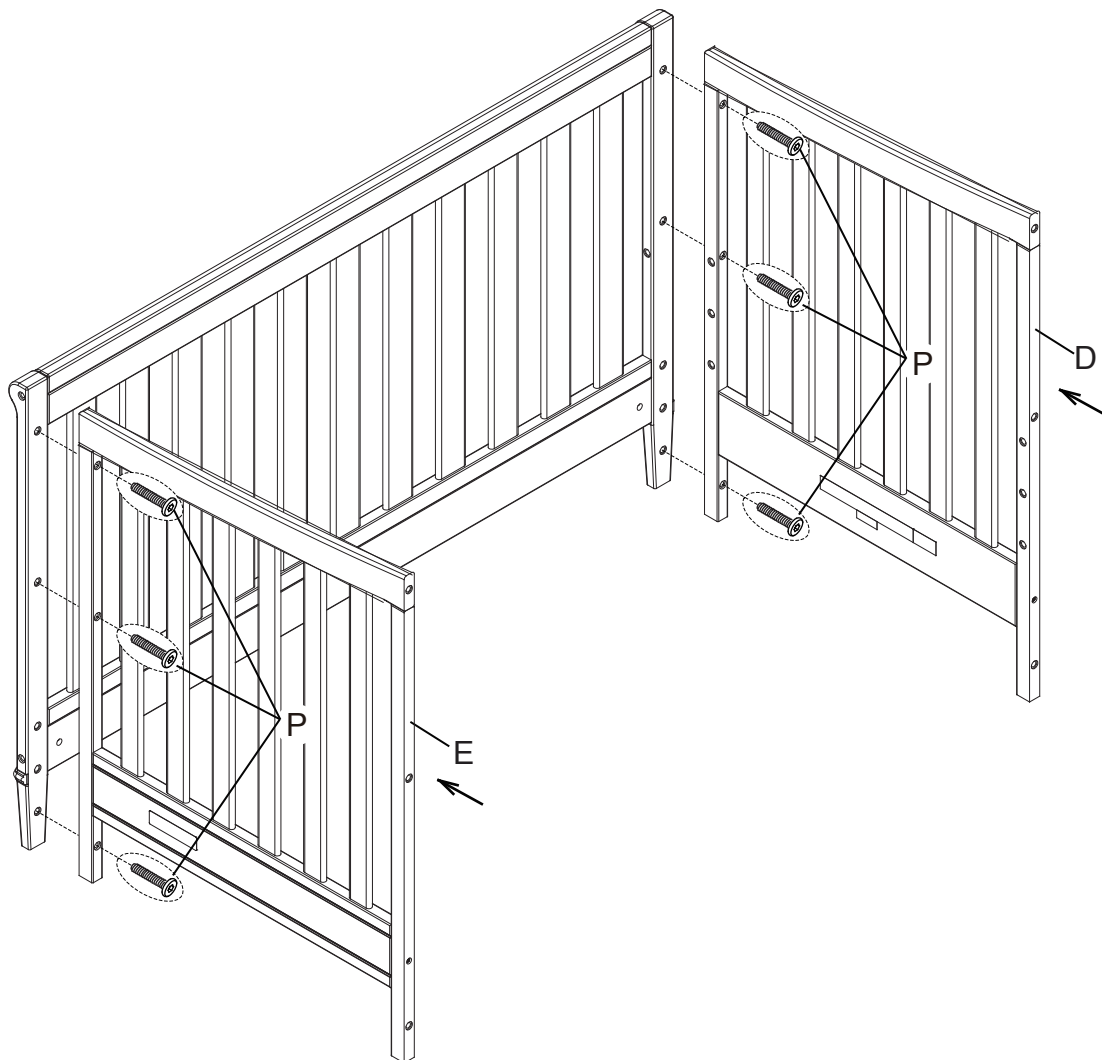

Section 1: Crib Assembly

Step 3

Parts and tools required to complete step.

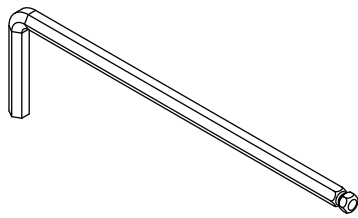

M4 Allen Wrench
Supplied

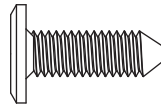
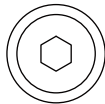

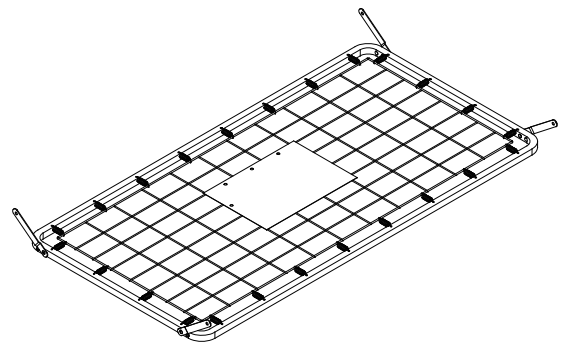

R. M6 x18 mm Bolt x 4

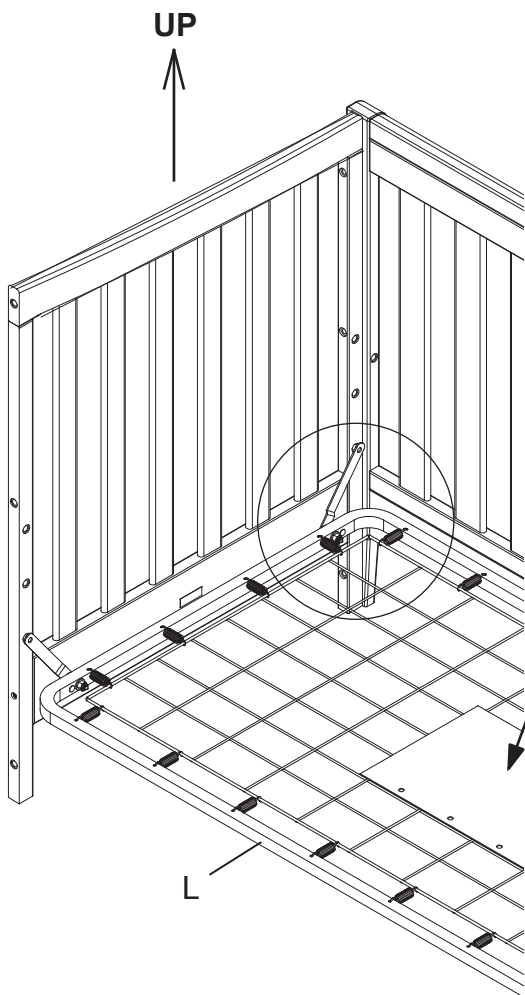

L. Mattress Support x 1

Attach the Mattress Support (Part L) in all corners using (1) M6 x18 mm Bolt (Part R) in each corner. Tighten with the M4 Allen Wrench.



The  Warnings printed on the pouch attached to the mattress support must face up, the springs must face up. This crib has (3) adjustment positions, use the highest only for new borns, move the mattress down as the child grows.

WARNING:

Fall Hazard: When child is able to pull to a standing position, set mattress to lowest position and remove bumper pads, large toys and other objects that could serve as steps for climbing out.

 **WARNINGS ON POUCH MUST FACE UP.**

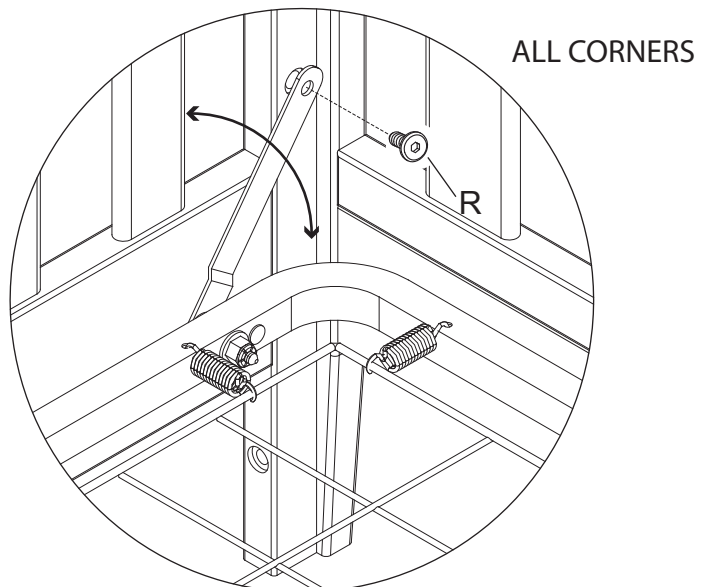

Section 1: Crib Assembly

Step 4

Parts and tools required to complete step.

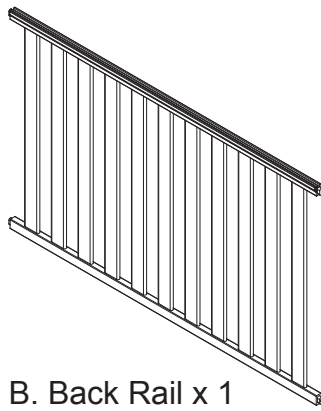

B. Back Rail x 1

G. Right Back Post x 1

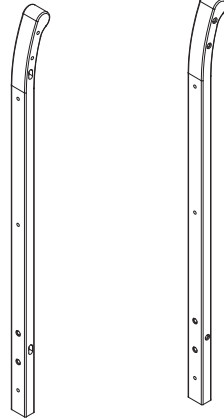

F. Left Back Post x 1



T. 10mm x 17mm Barrel Nut x 2

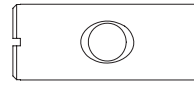

M4 Allen Wrench
Supplied

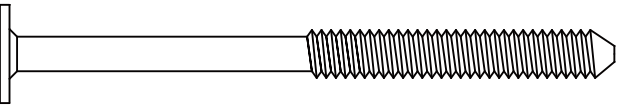
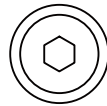

M. M6 x 80 mm Bolt x 2

Attach (1) Back Rail (Part B) to (1) Left Back Post (Part F) and (1) Right Back Post (Part G) using (2) M6 x80 mm Bolts (Part M) and (2) 10mm x 17 mm Barrel Nuts (Part T). Tighten with the M4 Allen Wrench. Use the Flat Head Screwdriver to hold the Barrel Nut in the proper alignment.

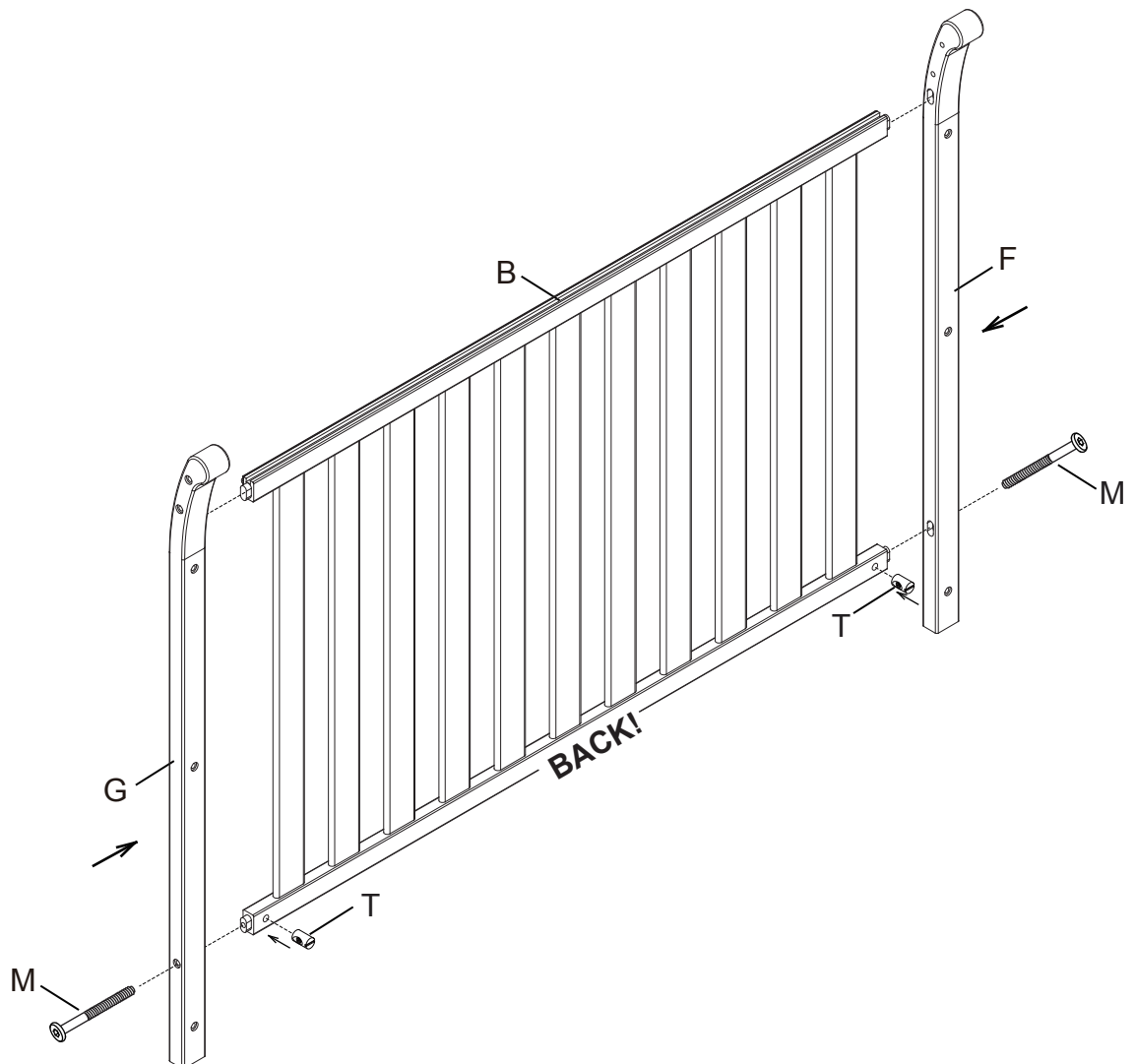

Section 1: Crib Assembly

Step 5

Parts and tools required to complete step.

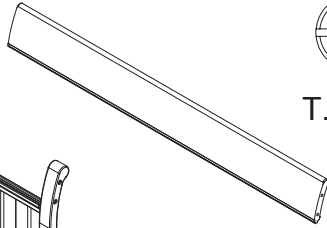
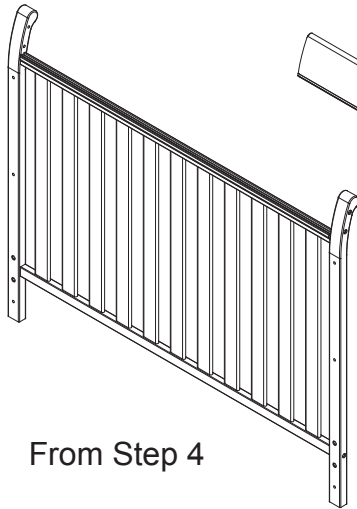

A. Top Back Rail x 1



T. 10mm x 17mm Barrel Nut x 4

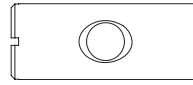

M4 Allen Wrench
Supplied

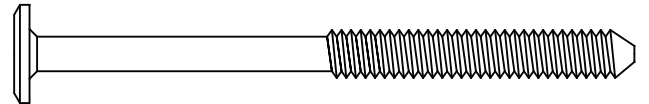
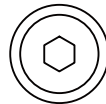

M. M6 x 80 mm Bolt x 4

Attach (1) Top Back Rail (Part A) to the assembly from step 4 using (4) M6 x80 mm Bolts (Part M) and (4) 10mm x 17 mm Barrel Nuts (Part T). Tighten with the M4 Allen Wrench. Use the Flat Head Screwdriver to hold the Barrel Nut in the proper alignment.

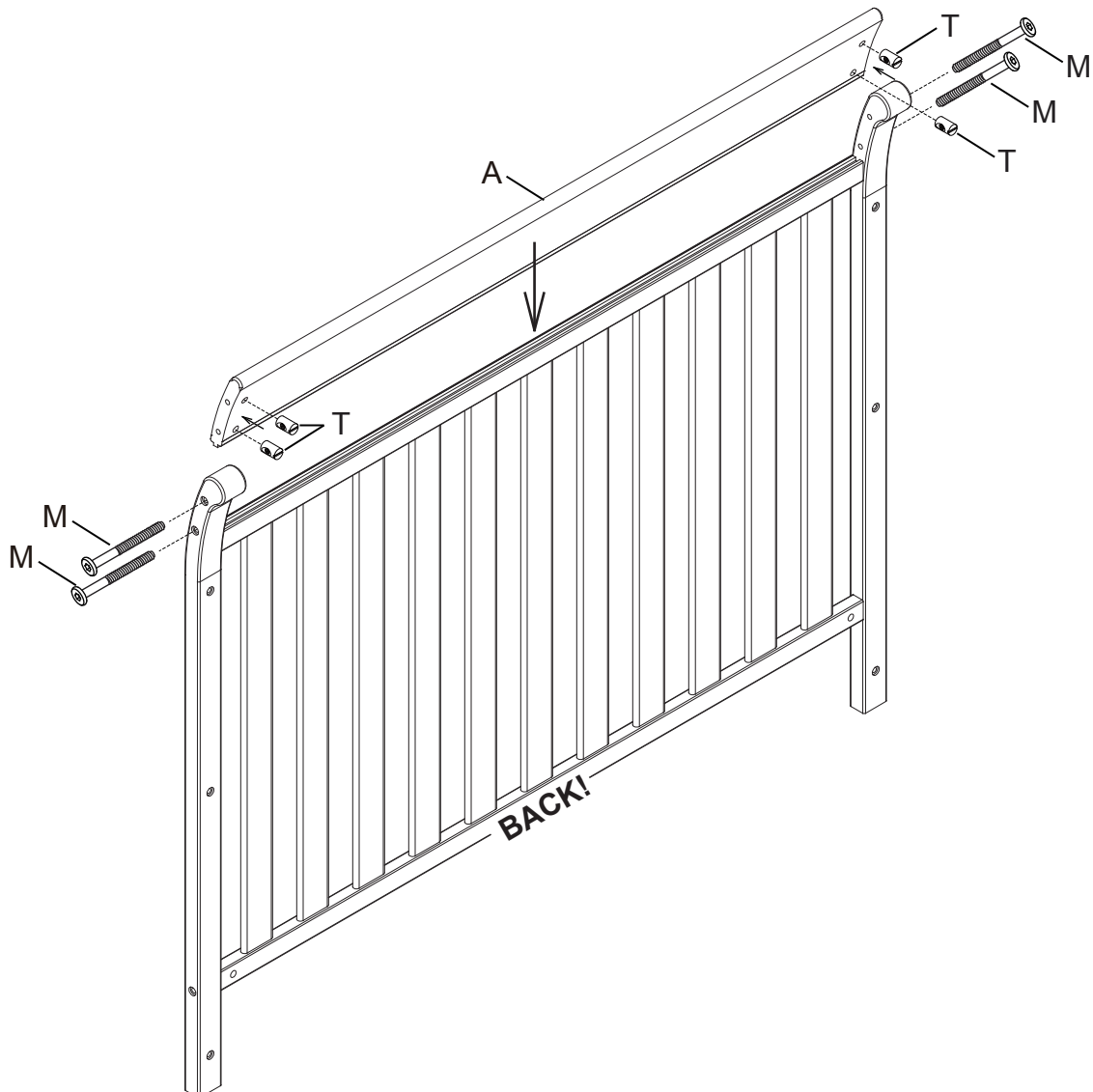

Section 1: Crib Assembly

Step 6

Parts and tools required to complete step.

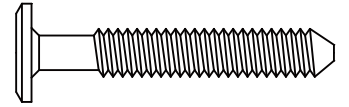
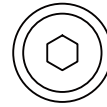
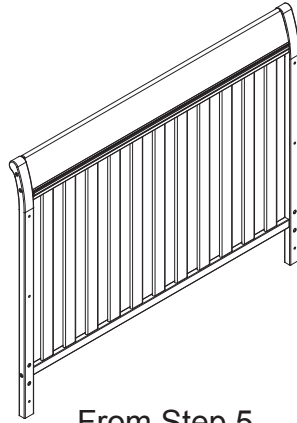

P. M6 x 40 mm Bolt x 6

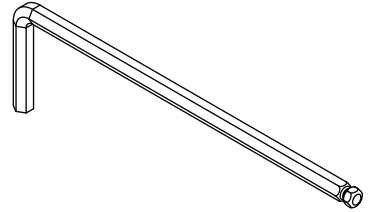

M4 Allen Wrench
Supplied

Attach the assembly from step 5 to the assembly from step 3 using (6) M6 x40 mm Bolts (Part P). Tighten with the M4 Allen Wrench.

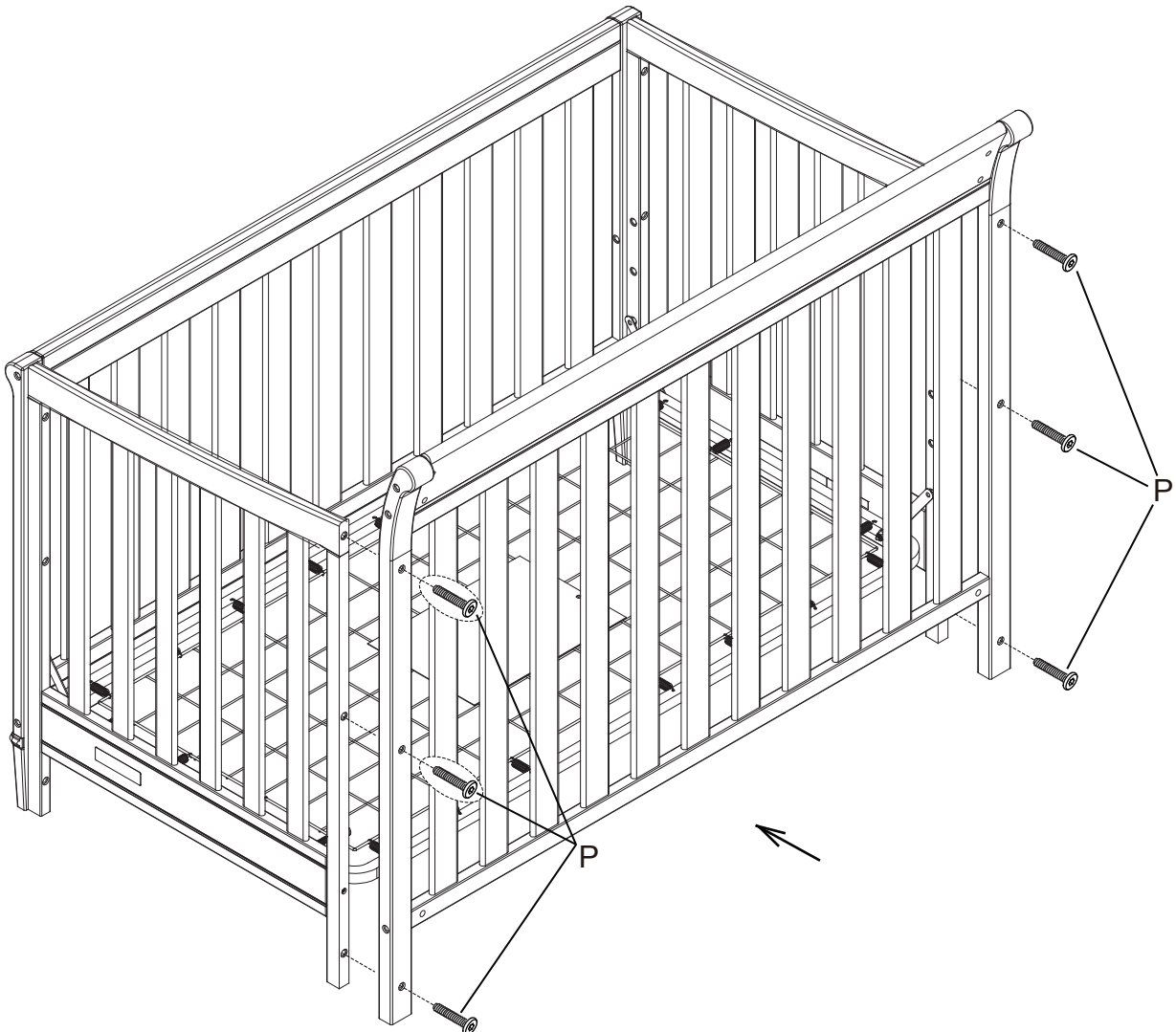

Section 1: Crib Assembly

Step 7

Parts and tools required to complete step.

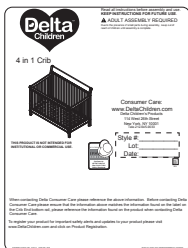

Assembly Instruction Booklet

Store the assembly instruction booklet in the pouch attached to the mattress support. Store all parts and tools separately, in a safe place.

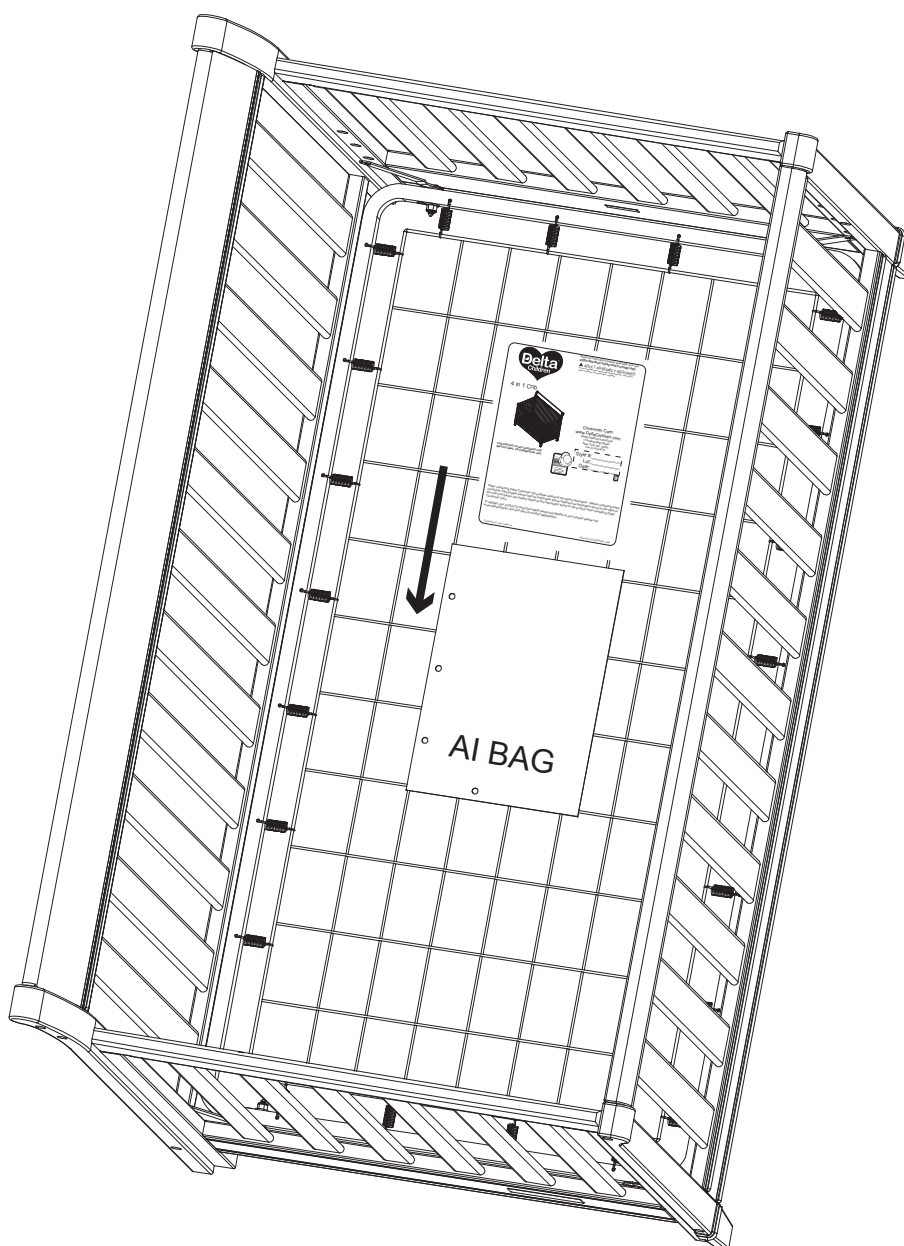

 **WARNING:** SEE PAGE 2 FOR INFORMATION

Section 2: Toddler Bed Conversion

Step 1

Parts and tools required to complete step.

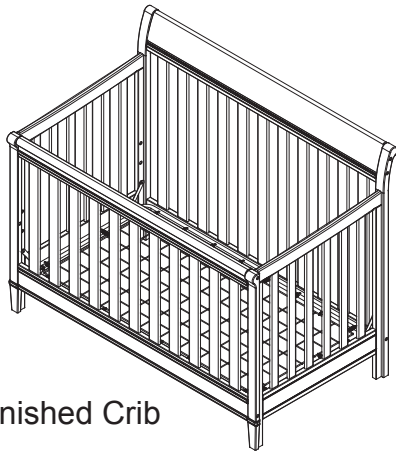

Finished Crib

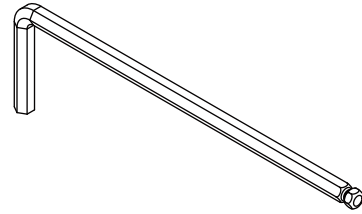

M4 Allen Wrench
Supplied

Remove the Front Rail installed in Step 2 of Section 1 crib assembly.

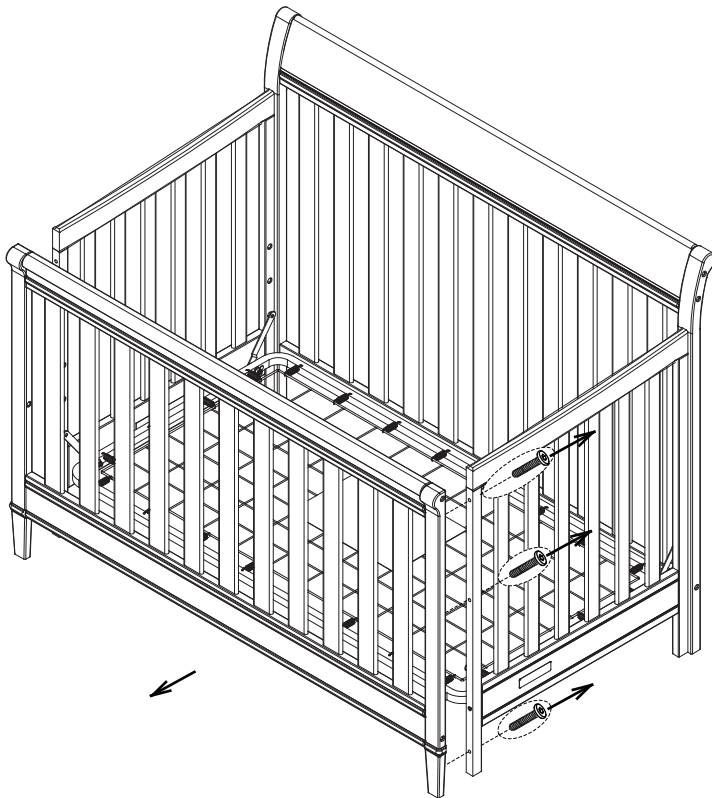

Section 2: Toddler Bed Conversion

Step 2

Parts and tools required to complete step.

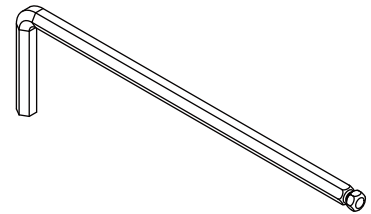

M4 Allen Wrench
Supplied

Disassemble the Front Rail using the M4 Allen Wrench. Then attach (1) Stabilizer Bar (Part K) to (1) Left Front Post (Part H) and (1) Right Front Post (Part J) using (2) M6 x80 mm Bolts (Part M) and (2) 10mm x17 mm Barrel Nuts (Part T). Tighten with the M4 Allen Wrench. Use the Flat Head Screwdriver to hold the Barrel Nut in the proper alignment.

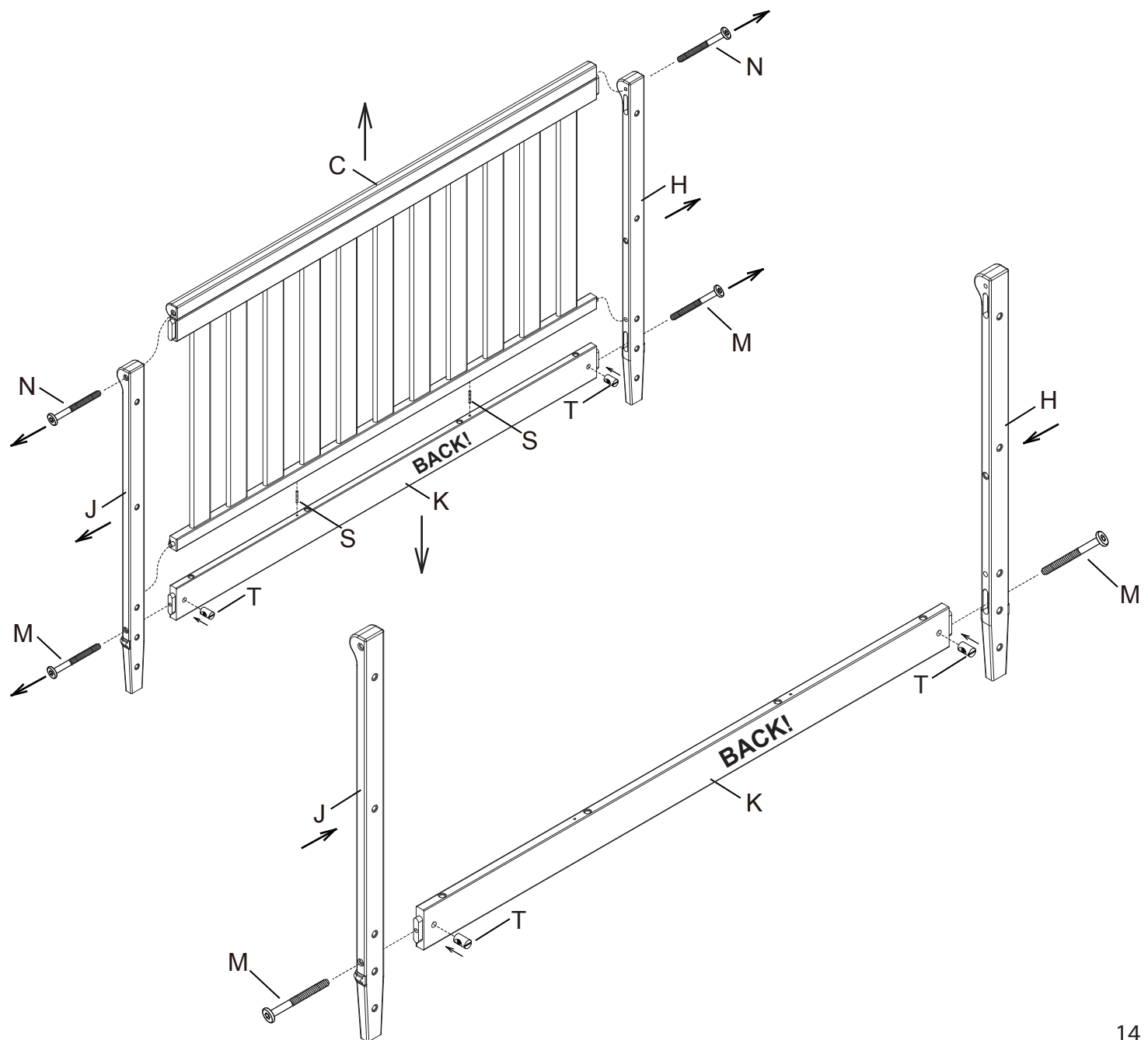

Section 2: Toddler Bed Conversion

Step 3

Parts and tools required to complete step.

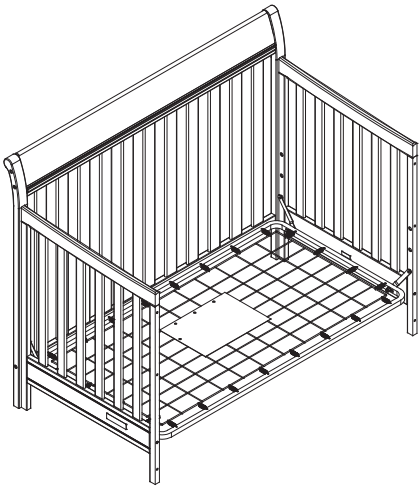

From Section 2 Step 1

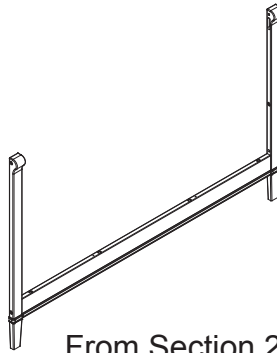

From Section 2 Step 2

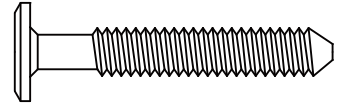
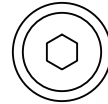

P. M6 x 40 mm Bolt x 6

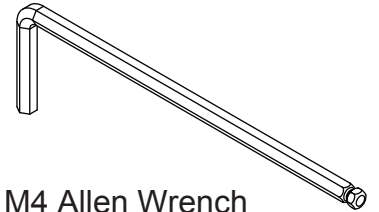

M4 Allen Wrench
Supplied

Attach the assembly from Section 2 Step 2 to the assembly from Section 2 Step 1 using (6) M6 x40 mm Bolts (Part P). Tighten with the M4 Allen Wrench.

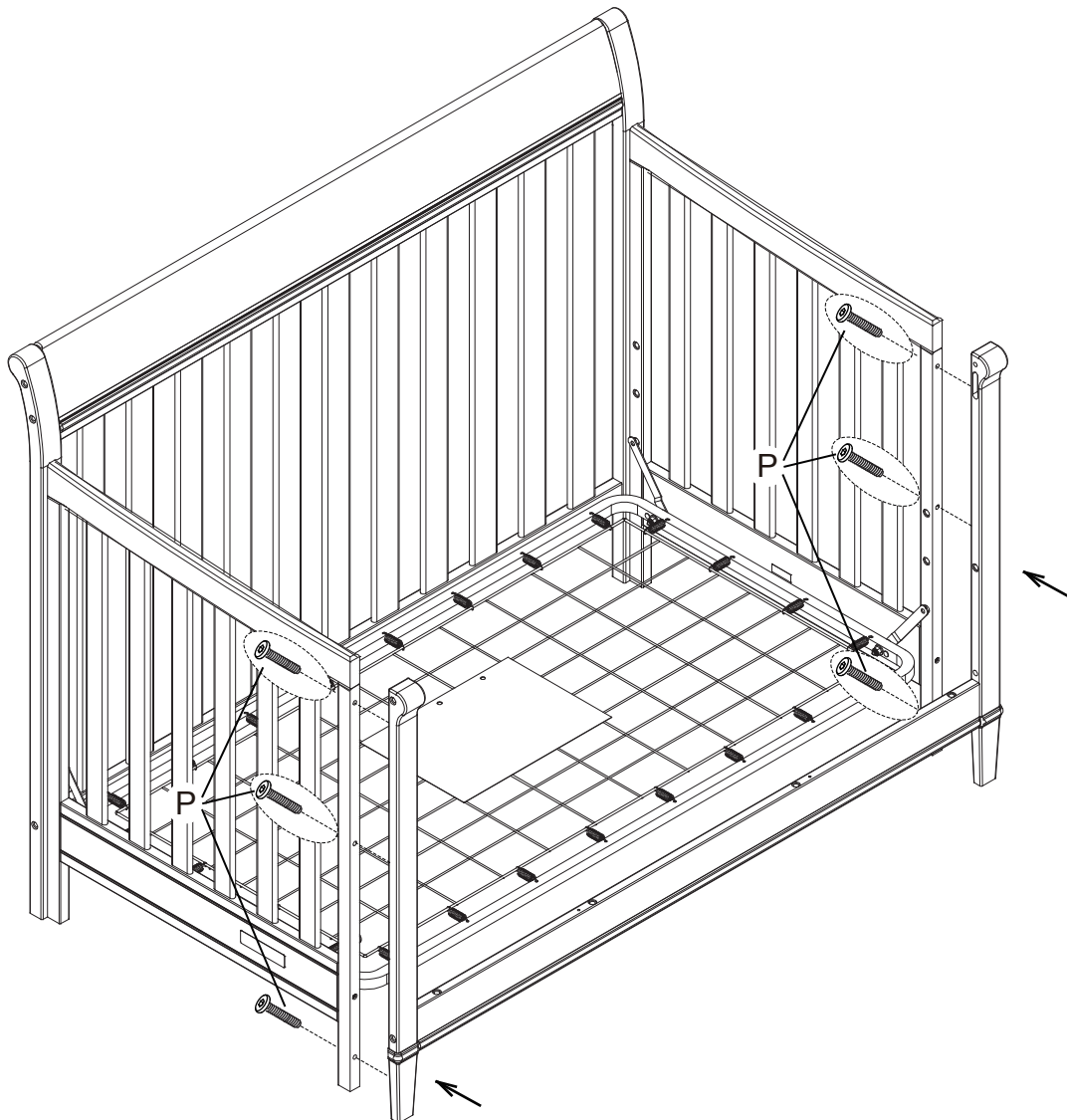

Section 2: Toddler Bed Conversion

Step 4

WARNING: **SEE PAGE 3 FOR** **TODDLER BED WARNINGS**

The mattress support must be in the lowest position.

Store all hardware safely.

Read all warnings on page 3.

As shown, use as a day bed or love seat sofa.

Do Not use without stabilizer bar installed.

 Stabilizer bar must be used when converted to a toddler bed.

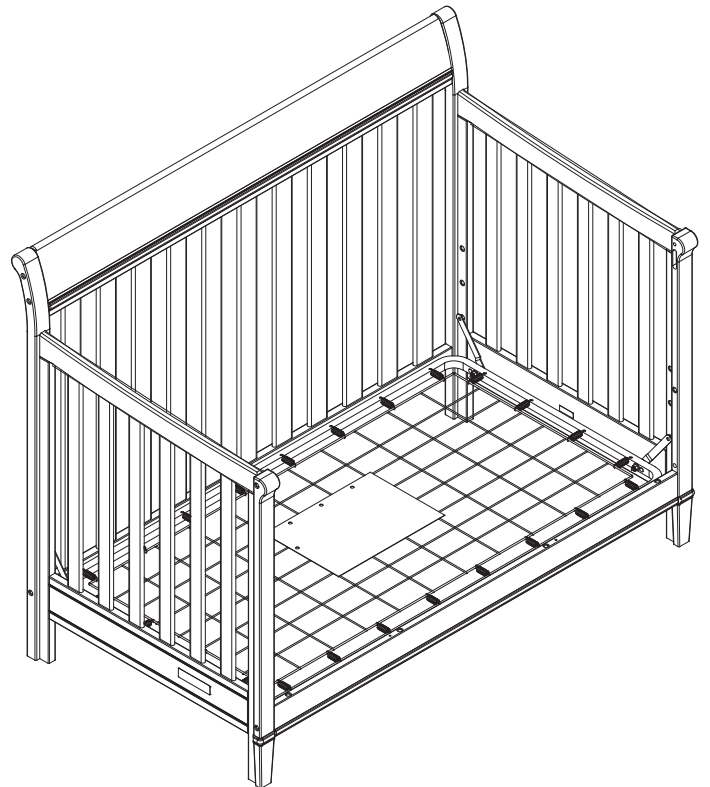

A toddler bed guardrail is available for this crib.

Please see your crib retailer, visit www.DeltaChildren.com or contact Delta Consumer Care for more information. This crib uses Delta Style # 0080 Guardrail.

Section 3: Full Size Bed Conversion

Step 1

Parts and tools required to complete step.

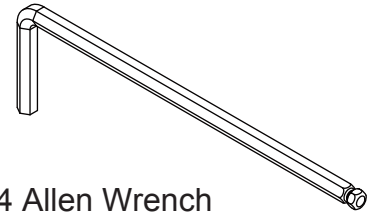

M4 Allen Wrench
Supplied

You have the option to convert the crib to a Full Size Bed. Simply follow steps in reverse order to disassemble the crib. The Headboard is the Back Rail assembly done through step 4 and 5 of section 1. To create the Footboard, Assemble the Left Front Post (Part H), Right Front Post (Part J), Front Rail (Part C) and Stabilizer Bar (Part K) using (2) $\Phi 4 \times 30$ mm Metal Pins (Part S), (2) M6 x 80mm Bolts (Part M), (2) M6 x 60mm Bolts (Part N) and (2) 10mm x 17 mm Barrel Nuts (Part T) as shown. Store all parts and hardware in a safe place.

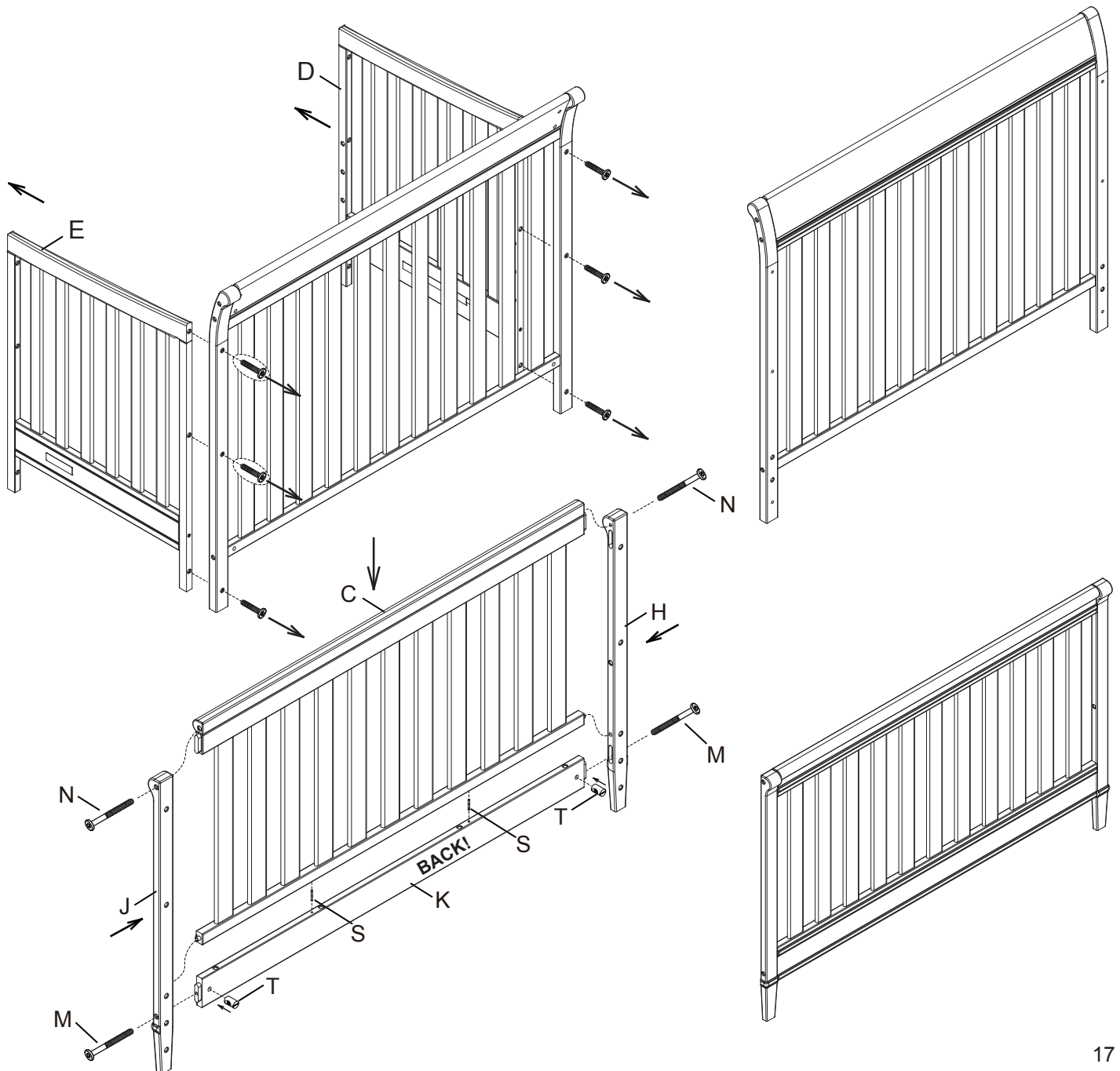

Section 3: Full Size Bed Conversion

Step 2

Parts and tools required to complete step.

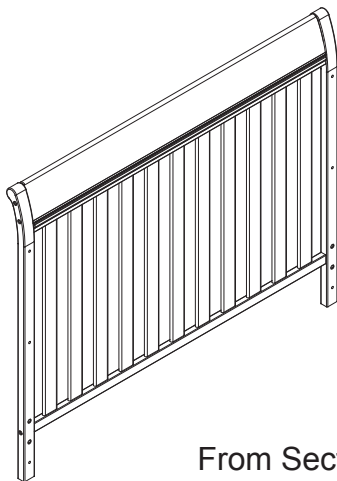

From Section 3 Step 1

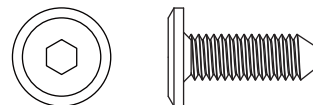
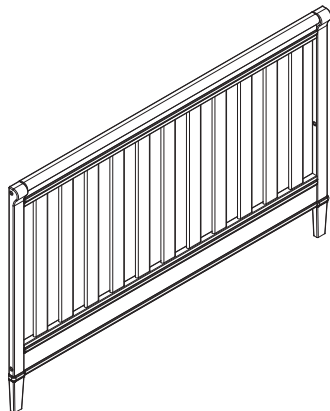

R. M6 x18 mm Bolt x 8

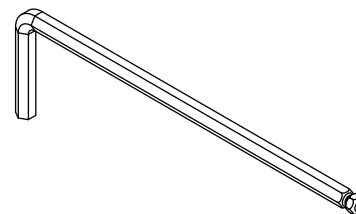

M4 Allen Wrench
Supplied

Attach Bed Rails to the Headboard (From Section 3 Step 1) and Footboard (From Section 3 Step 1) using (8) M6 x18mm Bolts (Part R). Follow all instructions supplied with the Bed Rails. This crib uses Style # 0050 Conversion Rails to convert to Full Size Bed (pictured below).

Note: Bed Rail System is not included, see your furniture or mattress retailer. Contact Delta Children's Products for information or with questions.

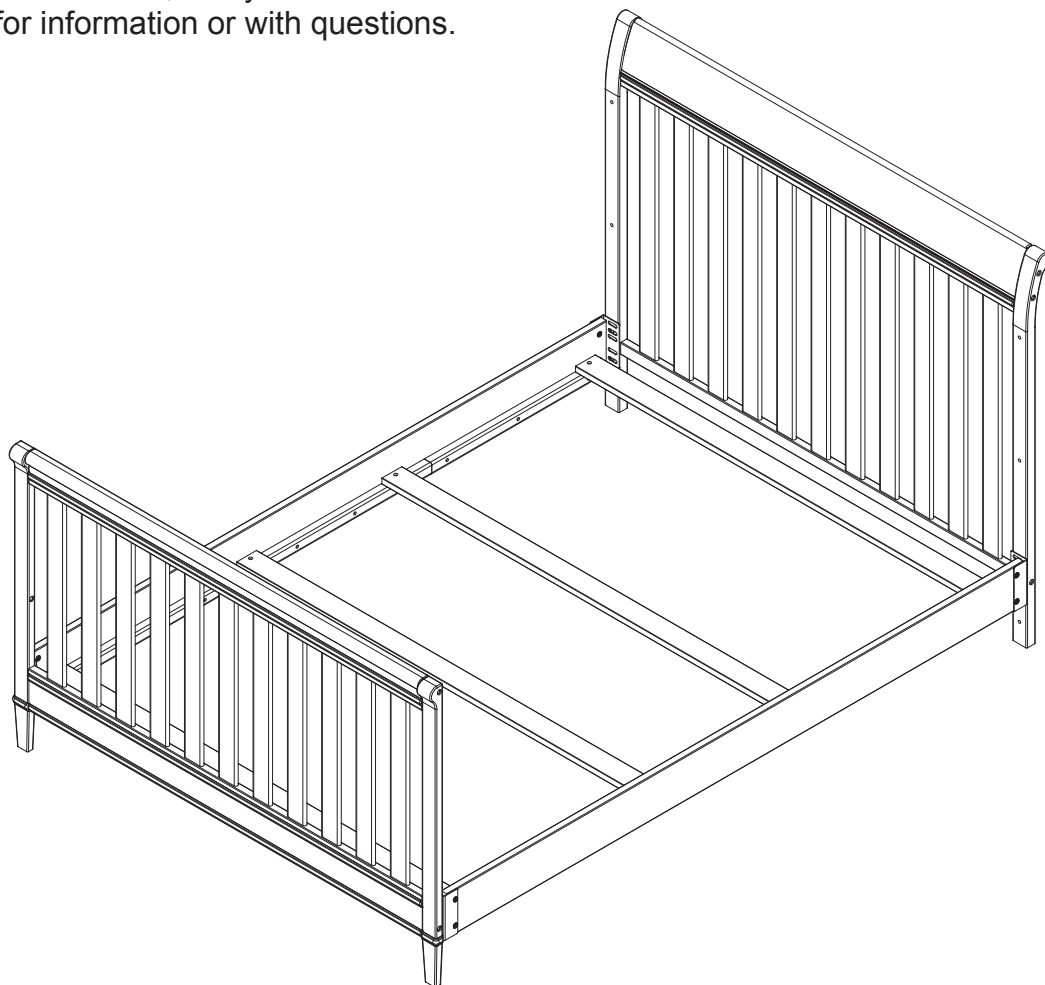

NOTE: SHOWN AS A FULL SIZE HEADBOARD AND FOOTBOARD, NOT ALL BED RAIL SYSTEMS ALLOW USE OF A FOOTBOARD.

As an alternative this item can be set up with only a headboard using Delta Item #0040 Metal Bed Frame (not pictured).



Consumer Care:
www.DeltaChildren.com
Delta Children's Products
114 West 26th Street
New York, NY 10001
Tele.212-645-9033

Warranty: This Delta Crib is warranted to be free from defects for a period of 1 year from the date of purchase under normal use. This warranty extends only to the original retail purchaser and is valid only when supplied with proof of purchase, or if received as a gift, when the registration is on file with Delta.

To register your product for important safety alerts and updates to your product please visit www.DeltaChildren.com

Please do not return this item to the store before contacting us about missing parts or with any questions.

To report a problem, please log on to www.DeltaChildren.com and click the Consumer Care Tab, or contact us by phone at (212) 645-9033.

In the event that you need to contact our customer service department please have the Style Number and Lot Number available. Use the space below to make note of those numbers. They can be found on the label on the Crib End bottom rail.

STYLE No: 7970

COLOR

REV

FTY

Lot No. : _____

Pack Date: _____

Date of Purchase: _____ (you should also keep your receipt)