

SWEET BEGININGS BASSINET

Model # 2502X-XXX SBBV10

ASSEMBLY INSTRUCTIONS
ADULT ASSEMBLY REQUIRED

Delta™

Children's Products

Styles and colors may vary



IMPORTANT: Read all instructions before assembly and use of the product
Keep the instructions for future reference
Required Tools: Screwdriver (not included)

Customer Care Tel. 1-(800)-377-3777

(J)

www.DeltaChildrensProducts.com

DCP Cat # 10-09-12-V10

Consumer Information



WARNING

Failure to follow these warnings and the instructions could result in serious injury or death.

- **Read all instructions before assembling unit.**

KEEP INSTRUCTIONS FOR FUTURE USE.

DO NOT USE THIS UNIT IF THE INSTRUCTIONS CANNOT BE STRICTLY FOLLOWED.

- Before each usage or assembly, inspect unit for damaged hardware, loose joints, missing parts or sharp edges. NEVER use this product if there are any loose or missing fasteners, loose joints, broken parts, or torn mesh/fabric. Check before assembly and periodically during use. Contact Delta Children's Product Customer Service Department at 1-800-377-3777 (8:00am ~ 4:30pm PST) for replacement parts, repair or instructions.
- **DO NOT** substitute parts.
- **FALL HAZARD**—To help prevent falls, DO NOT use this product when the infant begins to push up on hands and knees or has reached manufacturer's recommended maximum weight of 15lbs. (6.8kg), whichever comes first.
- Use bassinet with only one child at a time.
- Strings can cause strangulation! DO NOT place items with a string around a child's neck, such as hood strings or pacifier cords. DO NOT suspend strings over a product or attach strings to toys.
- **SUFFOCATION HAZARD:** Infants can suffocate:
 - In gaps between an extra pad and side of the bassinet/cradle.
 - On soft bedding.
- Use ONLY the pad provided by the manufacturer. **NEVER** add a pillow, comforter or another mattress for padding.
- If a sheet is used with the pad, use only the one provided by the manufacturer or one specifically designed to fit the dimensions of the bassinet/cradle.
- To reduce the risk of SIDS, pediatricians recommend healthy infants be placed on their back to sleep, unless otherwise advised by your physician.
- Never use plastic shipping bags or other plastic film as a mattress covers not sold and intended for that purpose. They can cause suffocation.
- **DO NOT** place bassinet near a window where cords from blinds or drapes may strangle a child. Child may fall out of window.
- **DO NOT** place cords, straps or similar items that could become wound around a child's neck in or near the bassinet.

CARE AND MAINTENANCE

Check bassinet for worn parts, torn material or stitching periodically. Replace or repair the parts as needed. Use Delta replacement parts.

Manufactured for and distributed by:

Delta
Children's Products

114 West 26th Street, New York, NY 10001



Customer Service

Tel. 1-(800)-377-3777

www.DeltaChildrensProducts.com

customerservice@DeltaChildrensProducts.com

MADE IN CHINA

Parts

IMPORTANT! Please remove all parts from the package and identify them before assembly.

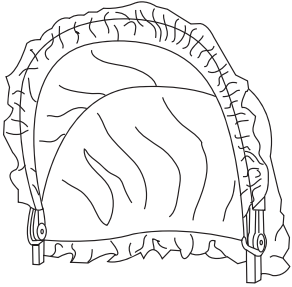

Canopy

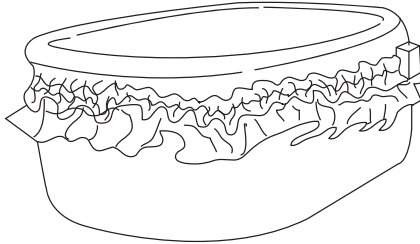

Bassinet Fabric Cover

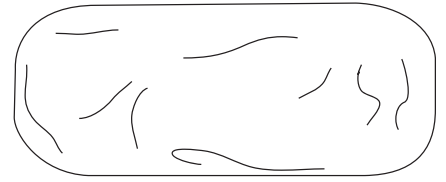

Mattress Pad

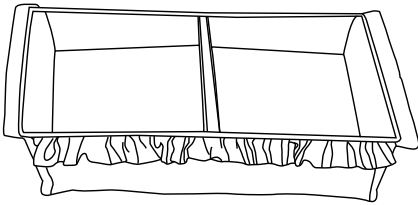

Storage Basket

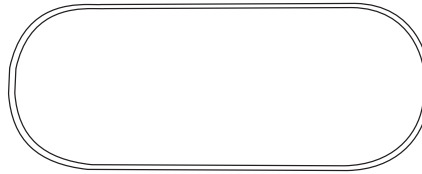

Mattress Support



Top Rail Frame

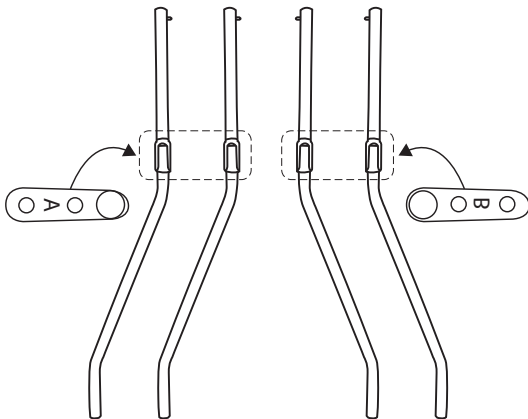

Support Legs
(2 X A / 2 X B)

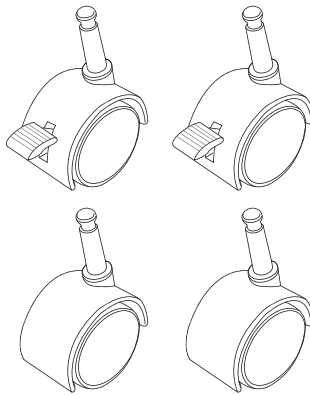

Caster (X2)
Locking Caster (X2)

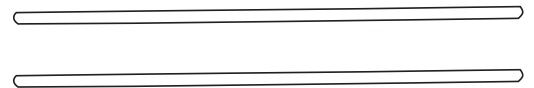

Basket Support Tubes

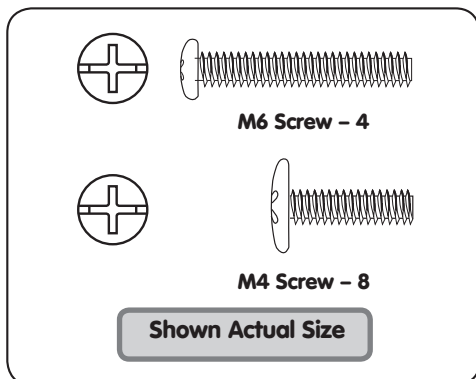

***(On Some models 25021, 25022)**



Music Module

Bassinet Assembly

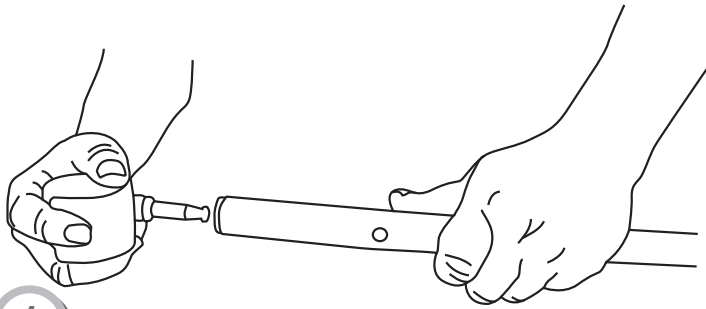

1

- Locate four (4) support legs and four (4) casters.
- Insert casters into the bottom of the support leg and push castor in until you hear it “clicks” into place.
- Pull on the castor to assure it is properly locked in place.
- Repeat for other three (3) support legs and casters.

Support Leg Insert

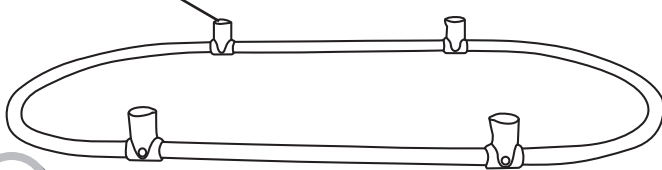

2

- Locate the top rail frame.
- Lay the top rail frame on the floor with the support leg inserts facing up.

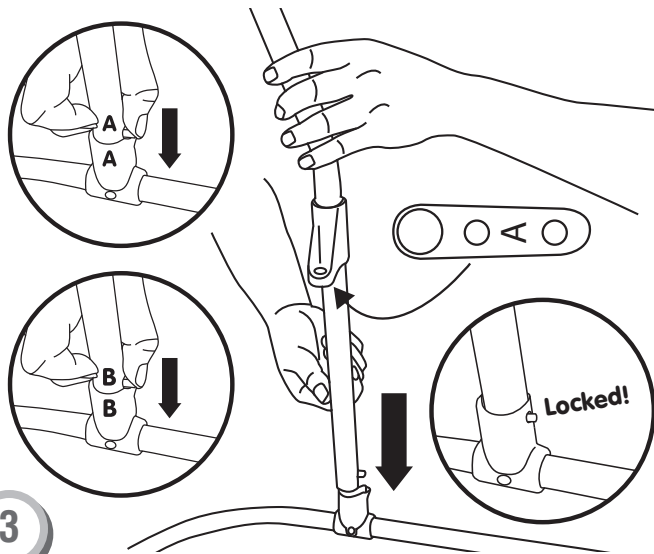

3

- Locate the four (4) support legs.
- Identify support legs labeled “A” and “B”.
- Align leg “A” with leg support insert “A”.
- Insert the support leg into the support leg insert and push the leg down until you hear it “click” into the locked position.
- Repeat for other support leg “A” and two support legs “B”.

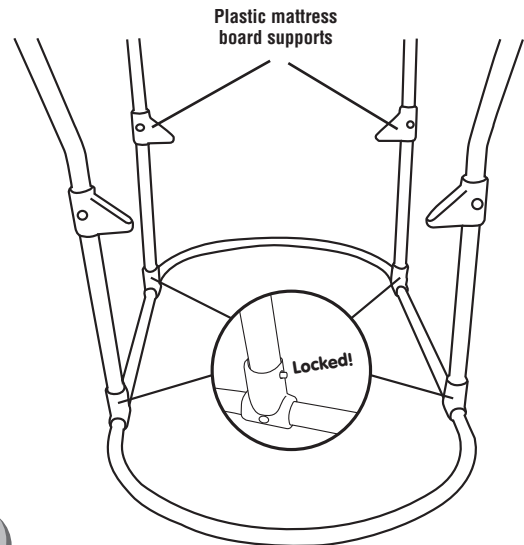

4

- Make sure all plastic mattress board supports are facing inward.
- Confirm that all four support legs have been properly inserted into the support leg inserts as shown above.
- Pull upon all support legs to assure they are properly locked to the top frame.

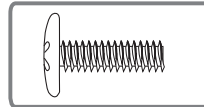

Mattress Board

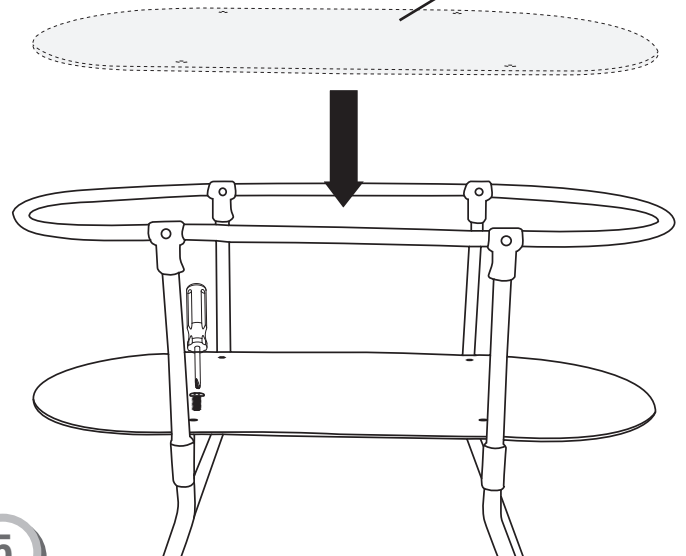

5

- Locate the mattress board and eight (8) M4 screws.
- Place the mattress board into the frame lining up the four through holes with the plastic mattress board support nuts.
- Using a screw driver and four (4) M4 screws, tighten the mattress board onto the plastic mattress board supports.
- Repeat this procedure for the four (4) remaining screw holes.

Bassinet Assembly

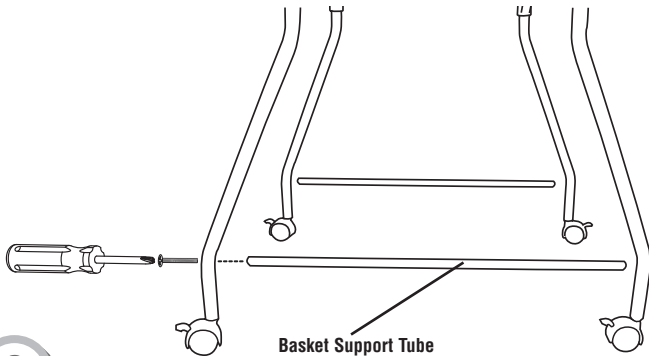
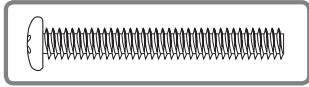

6

- Locate the two (2) basket support tubes.
- Insert and fasten only one side of the two support tubes with M6 x 4cm screws through the holes in the legs and basket support tubes.
- Repeat the same procedure for second basket support tube.

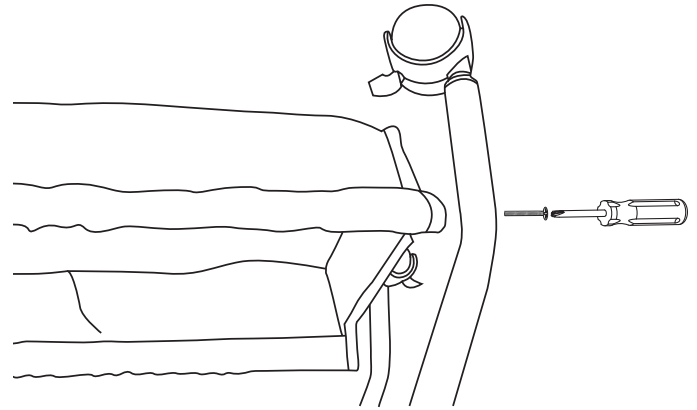

8

- Locate remaining two (2) M6 screws.
- Using the screw driver and M6 screw, tighten the screw to the basket support tube.
- Repeat this procedure for second basket support tube.

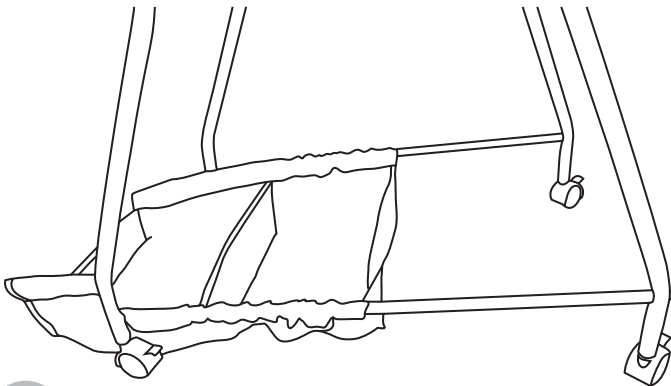

7

- Locate the storage basket.
- With the bottom of the storage basket facing up insert the basket support tubes into the storage basket sleeves.

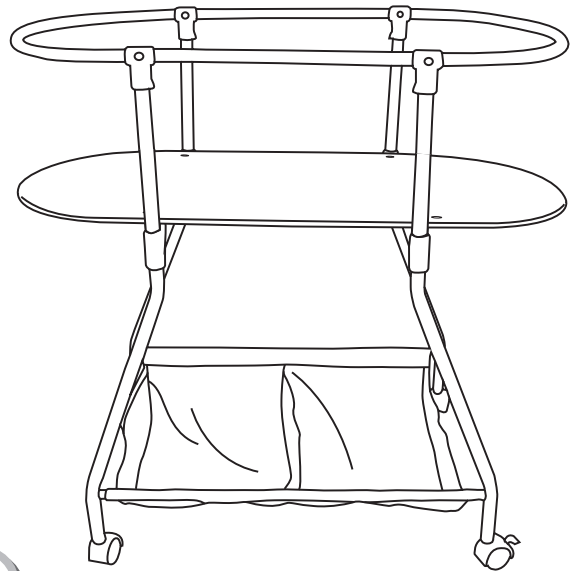

9

- Turn frame over into the up right position.

Battery Safety Information (On Some Models)

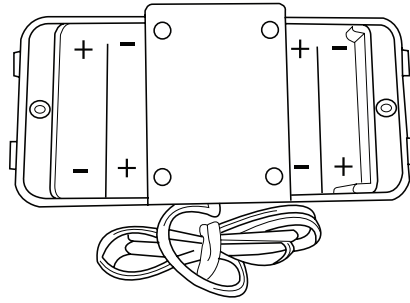

In exceptional circumstances, batteries may leak fluids that can cause a chemical burn injury or ruin your product. To avoid battery leakage:

- Do not mix old and new batteries or batteries of different types: Alkaline, standard (carbon zinc) or rechargeable (nickel-cadmium).
- Insert batteries as indicated inside battery compartment.
- Remove batteries during long periods of non-use. Always remove exhausted batteries from the product. Dispose of batteries safely. Do not dispose of product in a fire. The batteries inside may explode or leak.
- Never short-circuit the battery terminals.
- Use only batteries of the same or equivalent type as recommended.
- Do not charge non-rechargeable batteries.
- Remove rechargeable batteries from the product before charging.
- If removable, rechargeable batteries are used, they are only to be charged under adult supervision.

Attaching Music Module (On Some Models)

- If your bassinet model does not have a music module, skip these steps.

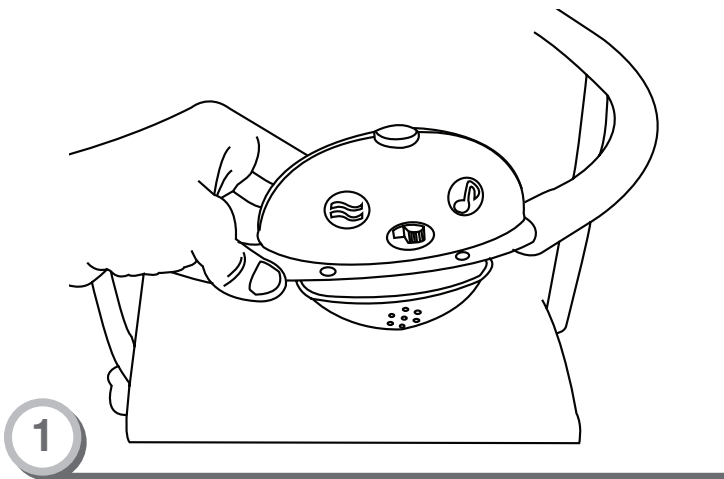

- To attach Music Module, remove screw plate in Music Module.

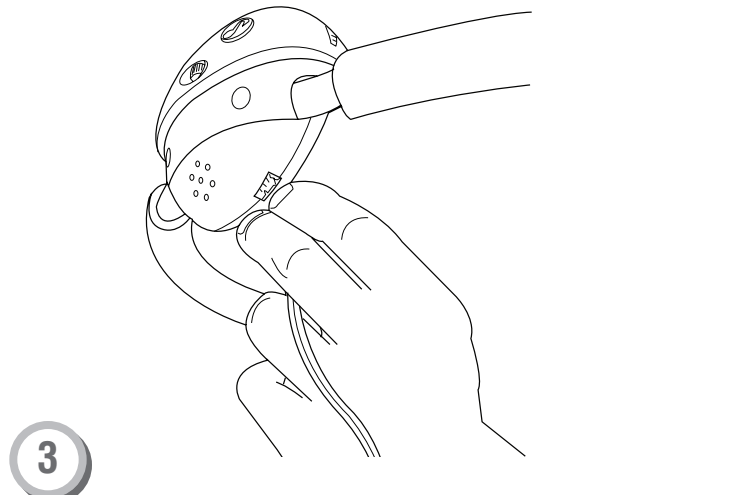

- Plug battery power line on underside of mattress support to Music Module.

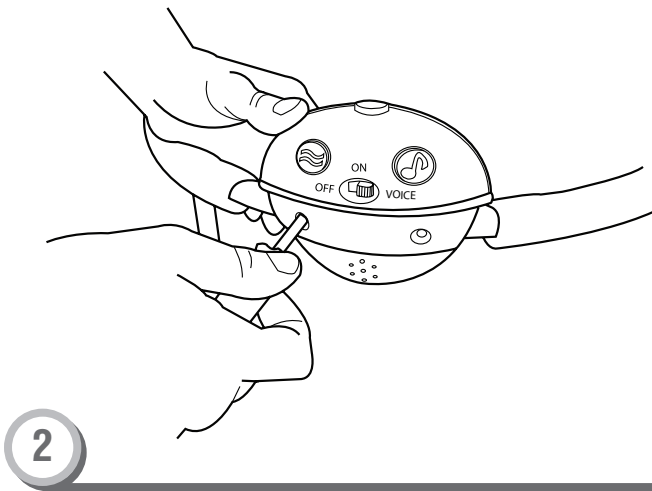

- Position Music Module onto mattress support frame and reattach screw plate.

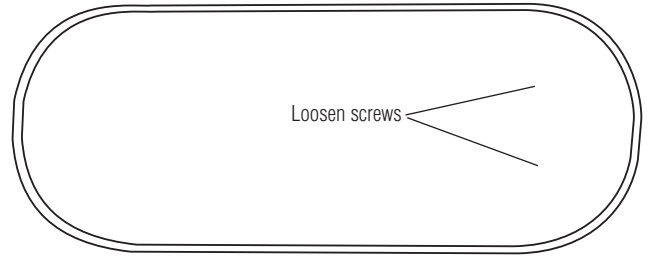

- Locate battery Compartment on underside of Mattress Support. Loosen screws in Battery Compartment with Phillips Head screwdriver (supplied)
 - Lift to remove door. Insert four (4) "AA" alkaline batteries.
 - Replace door and tighten screws.
- HINT:** We recommend using alkaline batteries for longer battery life.

Music Module Operation (On Some Models)

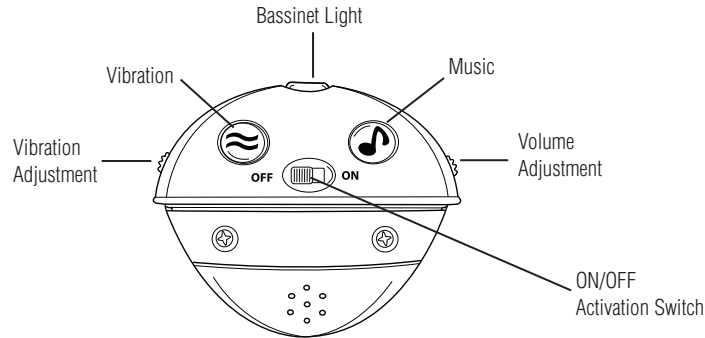

- To turn music box "ON," move ON/OFF ACTIVATION SWITCH to "ON."

NOTE: On some models

- Activate BASSINET LIGHT by pressing BASSINET LIGHT button.

NOTE: Light will stay on in 5-minute cycles, unless button is pressed before 5 minutes are up.

- Press VIBRATION button to activate VIBRATION. The strength can be adjusted with VIBRATION ADJUSTMENT knob on left.

NOTE: Vibration will stay on in 5-minute cycles, unless button is pressed before 5 minutes are up.

NOTE: On some models

- Press MUSIC button to activate MUSIC. Press button multiple times to cycle through two (2) modes of music; one to musical chimes and back to "OFF." VOLUME can be adjusted with VOLUME ADJUSTMENT knob on right.

- To turn music box "OFF," move ON/OFF ACTIVATION SWITCH to "OFF".

Bassinet Assembly

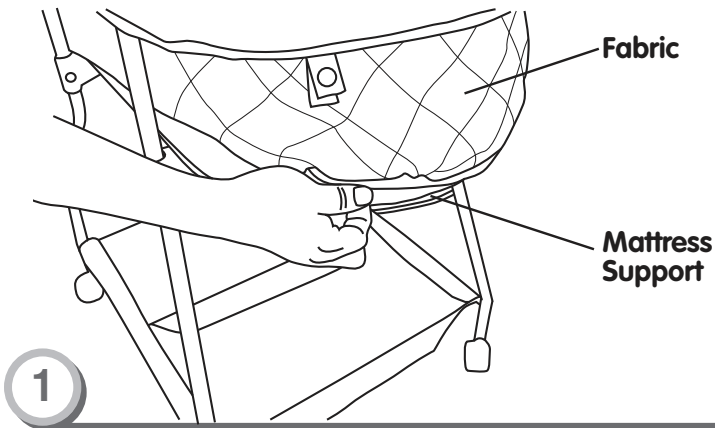

- Place the liner into frame. Make sure warning label is centered at the end of bassinet.

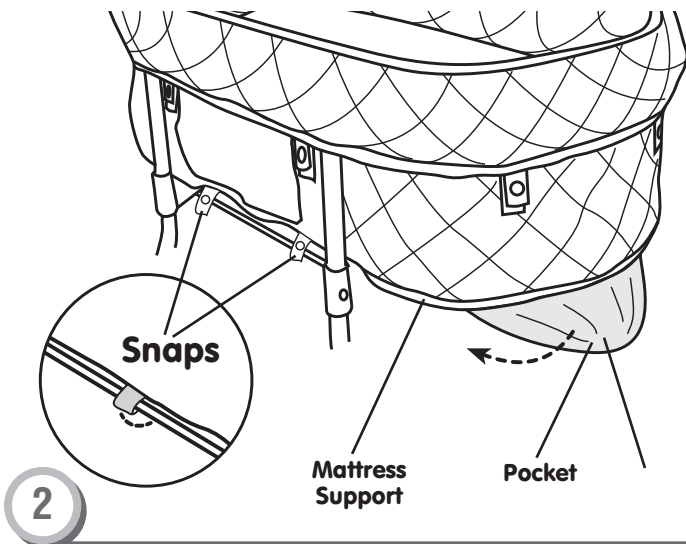

- Stretch the pockets on the bottom of the liner around the ends of the mattress support.

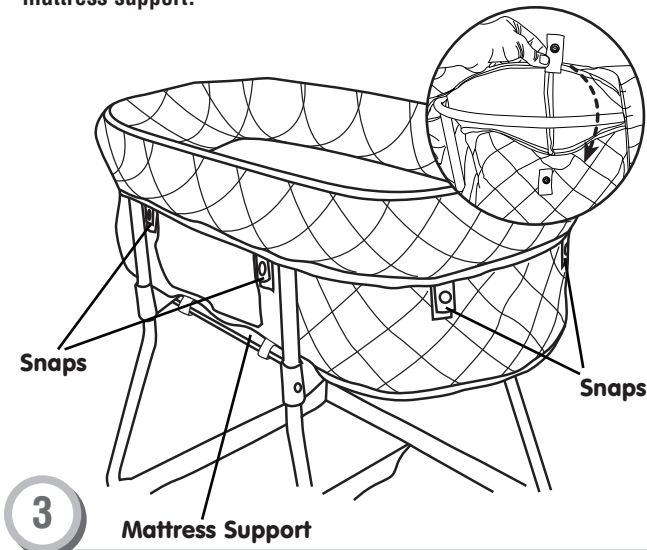

- Lift the skirt on the liner. Snap all 4 straps around the top of the side of the frame.
- Repeat this procedure to snap the other 4 straps around the top of the frame.

Place Sheet on Mattress Pad

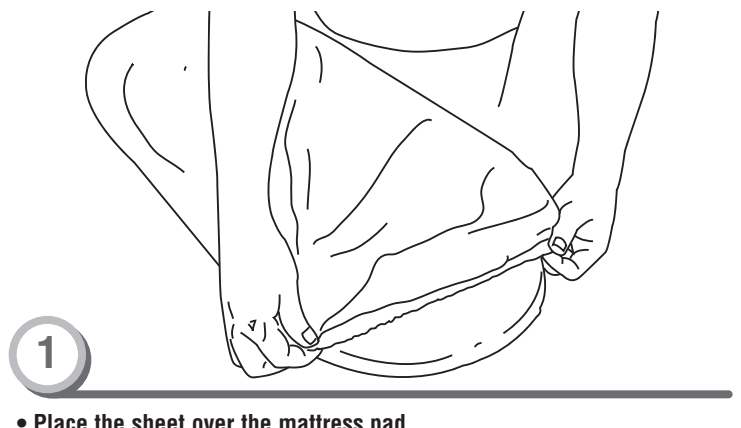

- Place the sheet over the mattress pad.

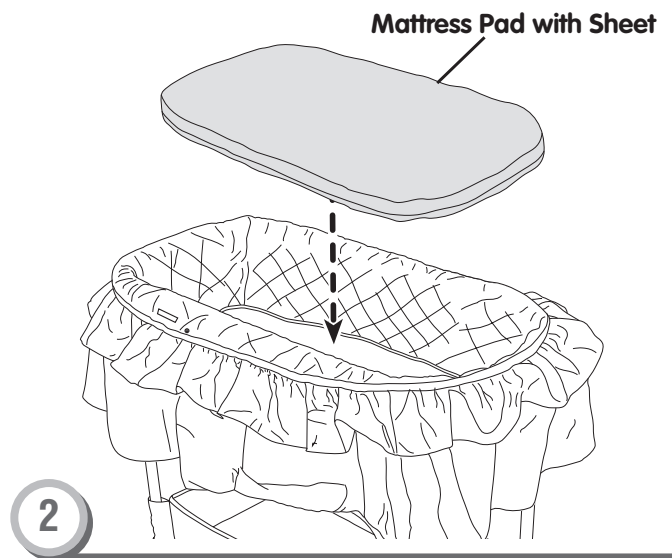

- Please place the mattress pad with sheet inside the bassinet for the safety and comfort of your baby.

To Attach Hood

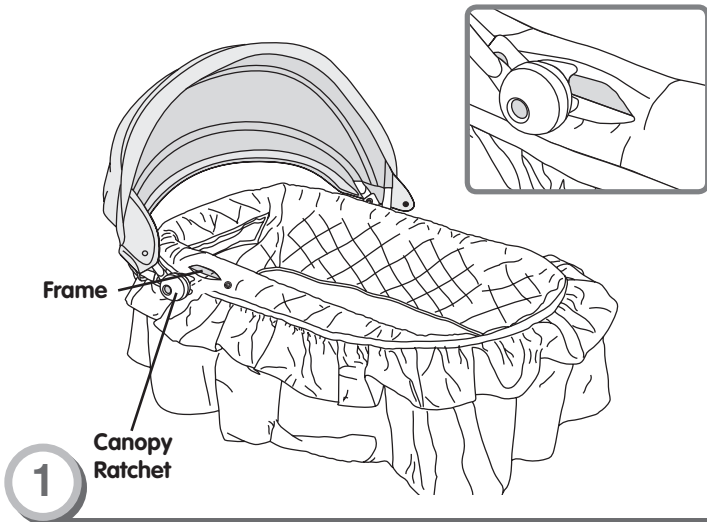

- Position the canopy over the top end of the bassinet opposite the warning label.
- Open the hole on the liner and push aside foam to expose metal.
- Push the canopy ratchet onto the frame on both sides of the bassinet.

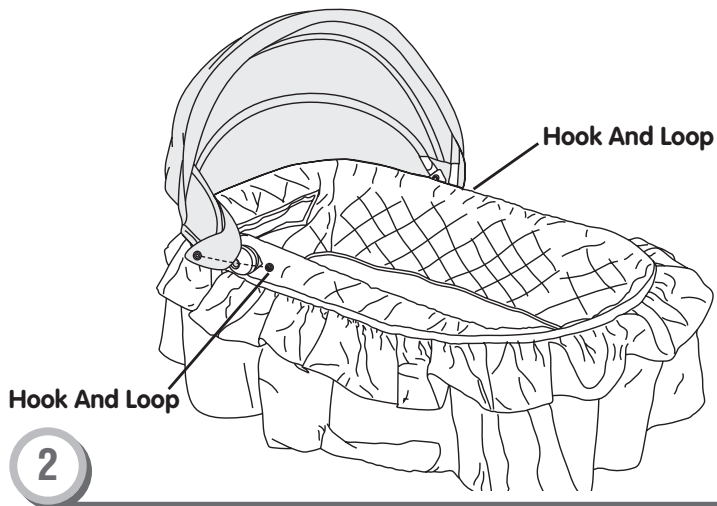

- Fasten the hook and loop on each canopy flap to the side of the bassinet liner.

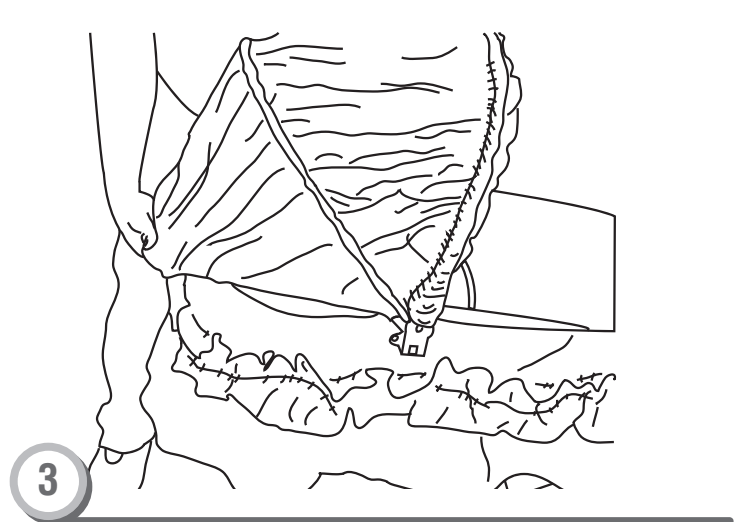

- Pull bottom back side of canopy over the bassinet top rail.

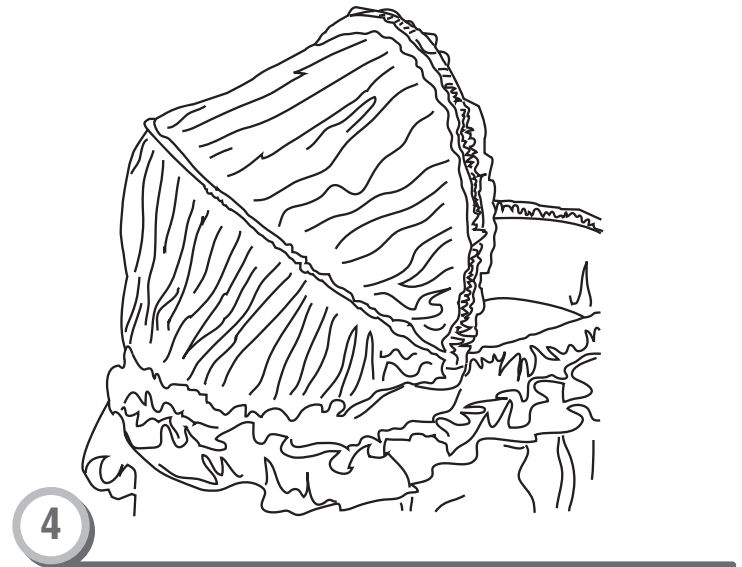

- **Hint:** For best result , make sure elastic is even across the back of the bassinet.

Manufactured for and distributed by:

Delta
Children's Products™

114 West 26th Street, New York, NY 10001



Customer Service

Tel. 1-(800)-377-3777

www.DeltaChildrensProducts.com

customerservice@DeltaChildrensProducts.com

MADE IN CHINA