

Delta™

Children's Products

Toddler Bed Guard Rail

Read all instructions before assembly and use.
KEEP INSTRUCTIONS FOR FUTURE USE.

▲ ADULT ASSEMBLY REQUIRED

Due to the presence of small parts during assembly, keep out of reach of children until assembly is complete.

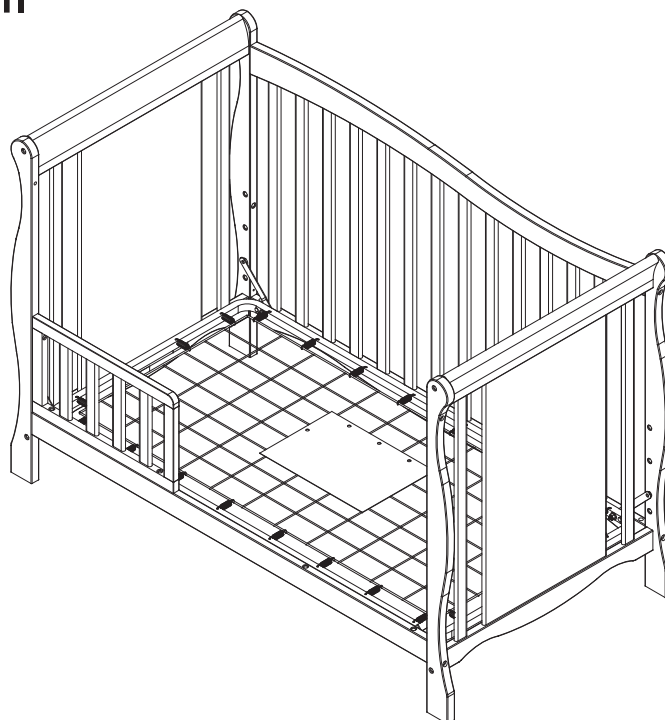

Crib not included shown as example only. Actual crib may vary.

THIS PRODUCT IS NOT INTENDED FOR INSTITUTIONAL OR COMMERCIAL USE.

Consumer Care:
www.DeltaChildren.com

Delta Children's Products
114 West 26th Street
New York, NY 10001
Tele.212-645-9033

Style #: _____
Lot: _____
Date: _____



When contacting Delta Consumer Care please reference the above information. Before contacting Delta Consumer Care please ensure that the information above matches the information found on the label on the bottom of Guard Rail, please reference the information found on the product when contacting Delta Consumer Care.

To register your product for important safety alerts and updates to your product please visit www.DeltaChildren.com and click on Product Registration.

TODDLER BED

⚠️WARNING

INFANTS HAVE DIED IN TODDLER BEDS FROM ENTRAPMENT.

Openings in and between bed parts can entrap head and neck of a small child.
NEVER use bed with children younger than 15 months.
ALWAYS follow assembly instructions.
The maximum user weight is 50lbs (22.7kg)

⚠️WARNING

STRANGULATION HAZARD

NEVER place bed near windows where cords from blinds or drapes may strangle a child.
NEVER suspend strings over a bed.
NEVER place items with a string, cord, or ribbon, such as hood strings or pacifier cords, around a child's neck. These items may catch on bed parts.

⚠️CAUTION

ENTRAPMENT HAZARD

To avoid dangerous gaps, any mattress used in this bed shall be a full-size crib mattress at least 51 5/8 in (1310mm) in length, 27 1/4 in (690mm) in width and 4 in (100mm) in thickness. The mattress thickness must not exceed 6 in (150mm).

NOTES ON ASSEMBLY:

- During the assembly process whenever using screws or bolts, check each by placing the screw/bolt on the diagram of the item which is drawn actual size and design. Be sure to use the proper size and shape specified in the instructions.
- To assemble this unit you may be required to place the unit on it's side and face. It is strongly recommended that assembly is done on a soft, non-abrasive surface to avoid damaging the finish.

NOTES ON USE:

Keep children and others safe by following these simple rules:

- **Do not** allow any child to play on furniture
- **Do not** allow climbing on any piece of furniture.
- **Do not** allow hanging from any piece of furniture.
- Always monitor your child's activity when in the nursery.

NOTES ON CARE AND MAINTENANCE:

- **Do not** scratch or chip the finish.
- Inspect the product periodically, contact Delta Children's Products for replacement parts or questions.
- **Do not** store the product or any parts in extreme temperatures and conditions such as a hot attic or a damp, cold basement. These extremes can cause a loss of structural integrity.
- To preserve the luster of the high quality finish on your product, it is recommended to place a doily or felt pad under any items you place on the finish.
- Clean with a damp cloth, then a dry cloth to preserve the original luster and beauty of this fine finish.
- Do not** use abrasive chemicals.
- Do not** spray cleaners directly onto furniture.
- Lift slightly when moving on carpeting to prevent leg breakage.
- Use of a vaporizer near furniture will cause wood to swell and finish to peel.

PARTS: HARDWARE KIT IS PART #24565-986 FOR COLOR 100 OR #24565-988 FOR COLOR 207 AND 648. SEE FRONT COVER.

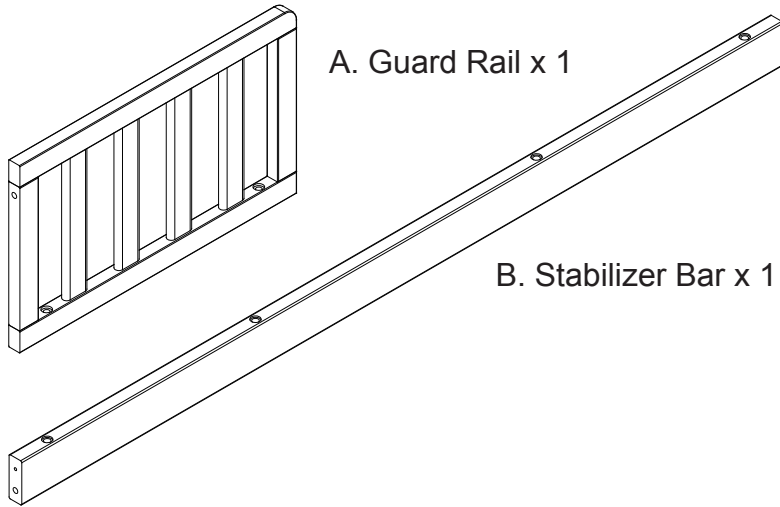

A. Guard Rail x 1

B. Stabilizer Bar x 1

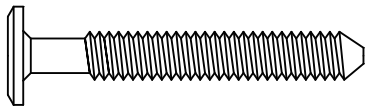
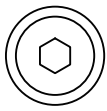

C. M6x45 mm Bolt x 3
Part # 5466



D. Φ 4x30 mm Metal Pin x 2
Part # 5493

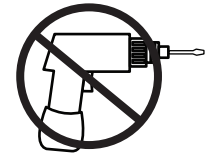

No drills necessary.
Do not use power
screwdriver.



Flat Head Screwdriver
(not supplied)



M4 Allen
Wrench Supplied
Part # 1177

Step 1

Remove only one side.

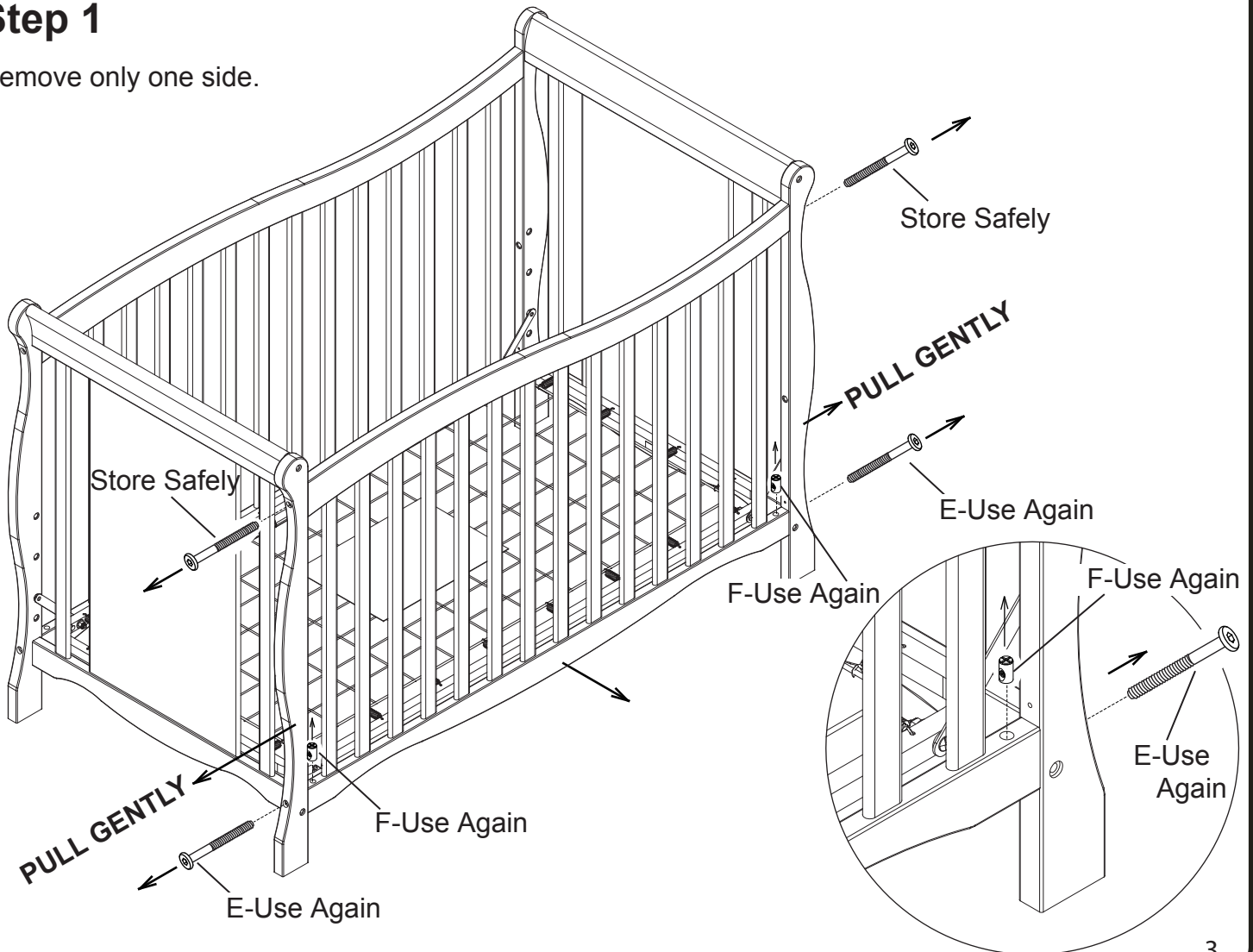

Step 2

Parts and tools required to complete step.

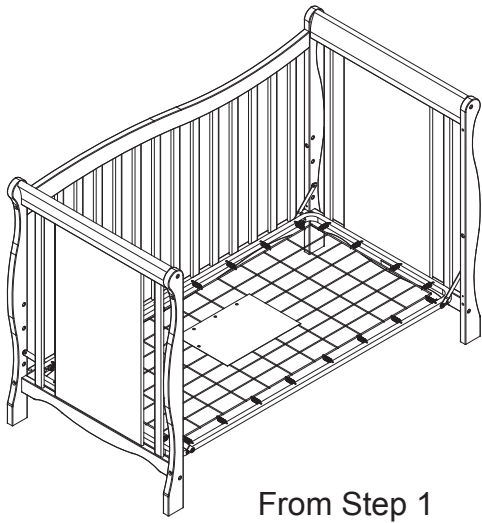

B. Stabilizer Bar x 1

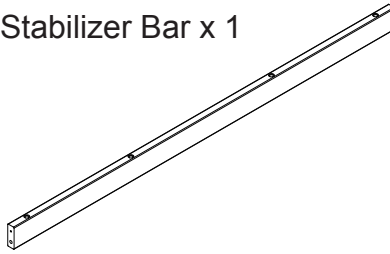

D. $\Phi 4 \times 30$ mm Metal Pin x 2

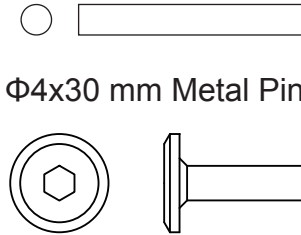

M4 Allen Wrench
Supplied

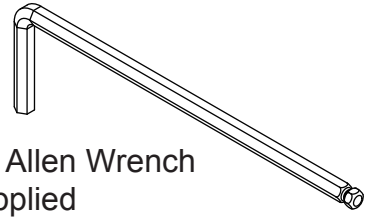

F. M6x17mm Barrel Nut x 2
(From Step 1)

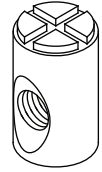

E. M6 x 80 mm Bolt x 2 (From Step 1)

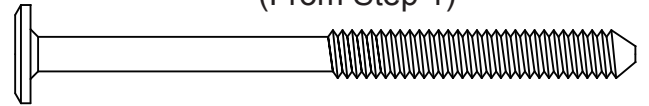

Attach the Stabilizer Bar (Part B) to the assembly from Step 1 using (2) $\Phi 4 \times 30$ mm Metal Pins (Part D), (2) M6x80mm Bolts (Part E) and (2) M6x 17mm Barrel Nuts (Part F). Tighten with the M4 Allen Wrench. Use the flat head screwdriver to hold the barrel nut in the proper alignment.

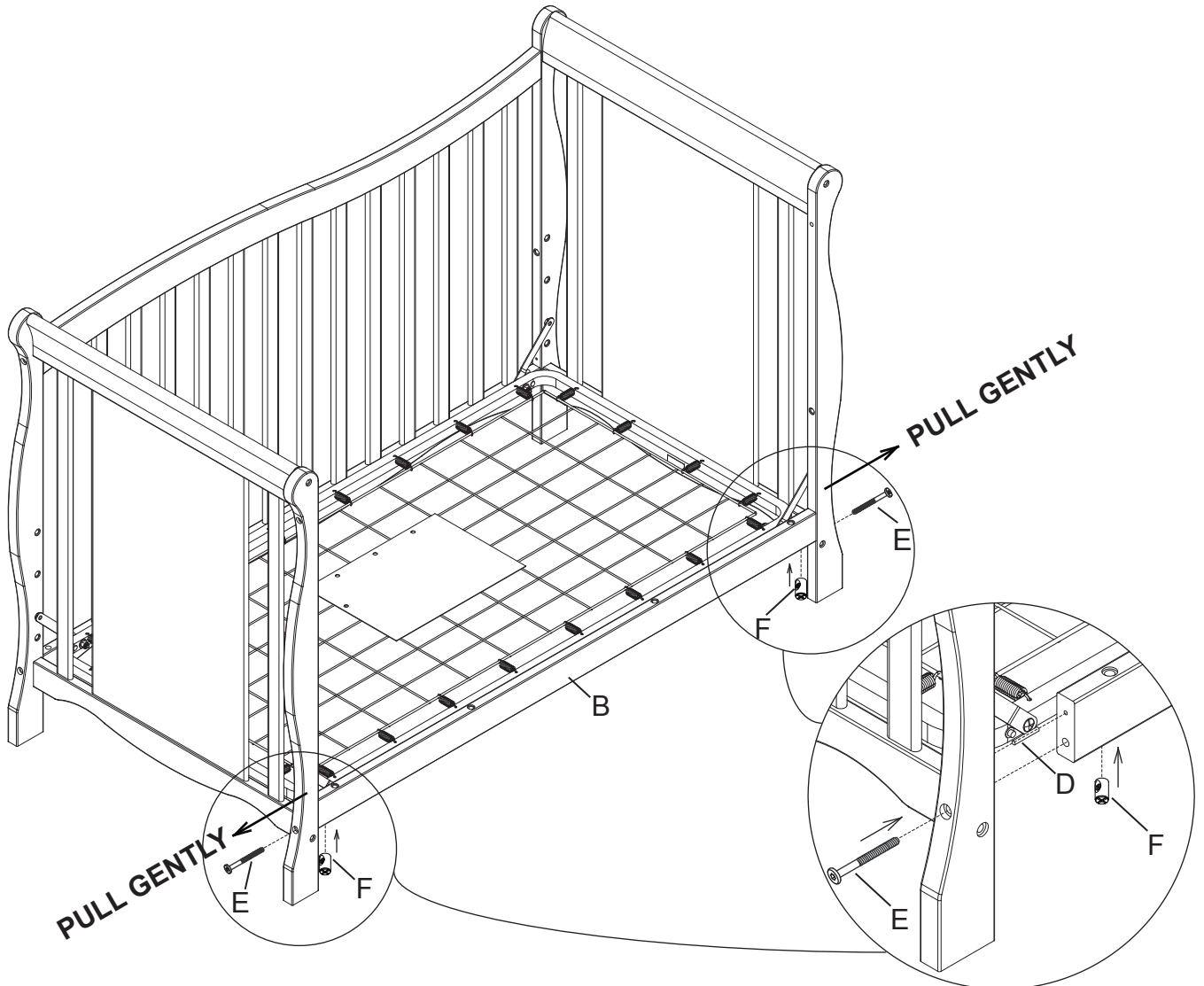

Step 3

1. Check to confirm that your Delta Crib Instructions indicate that it can use the 0089 Toddler Bed Guard Rail.
2. Follow all instructions included with the crib.
3. Determine if you will install on the right or left, ensure there are inserts on the stabilizer rail where you choose to install the guard rail.
4. Attach the Guard Rail (Part A) to the Crib Stabilizer Bar using (2) M6x45mm Bolts (Part C) as shown above.
5. Attach the Guard Rail to the Crib Post using (1) M6x45mm Bolts (Part C)
6. Tighten all bolts with the M4 Allen Wrench Provided.

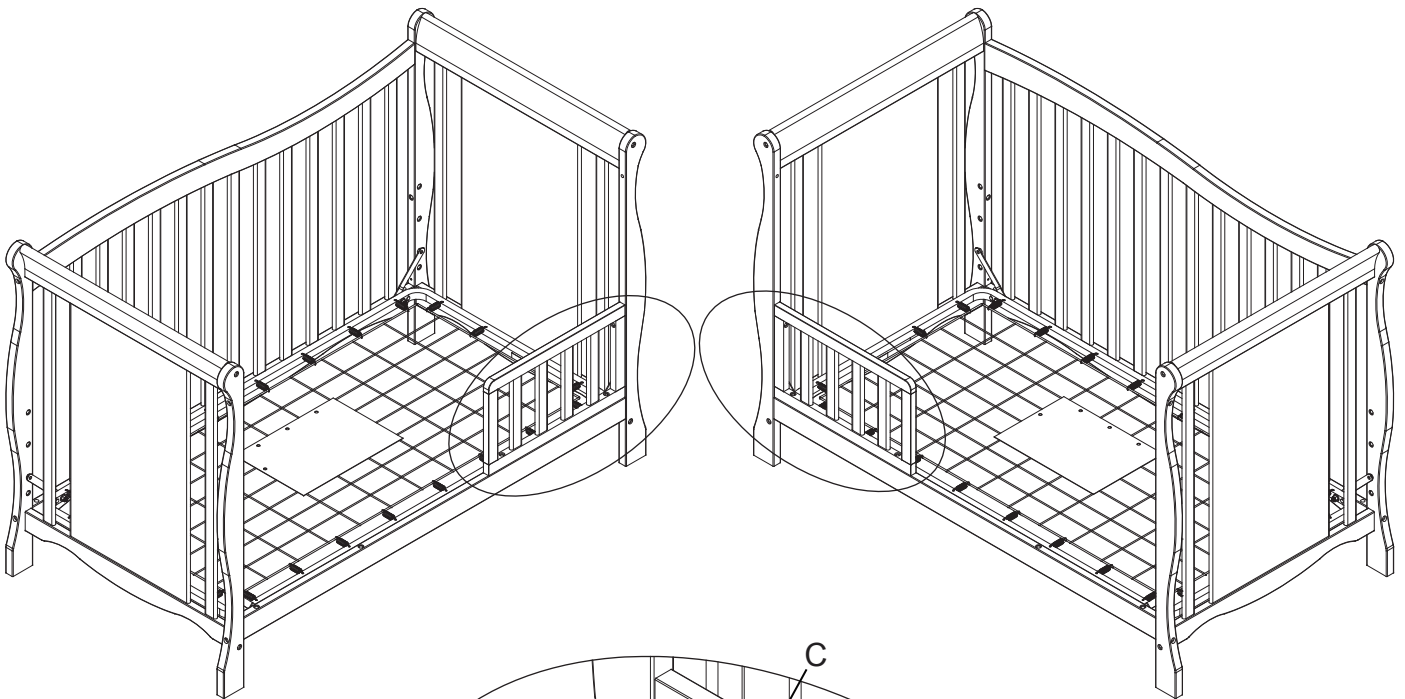

Right Installation

Left Installation

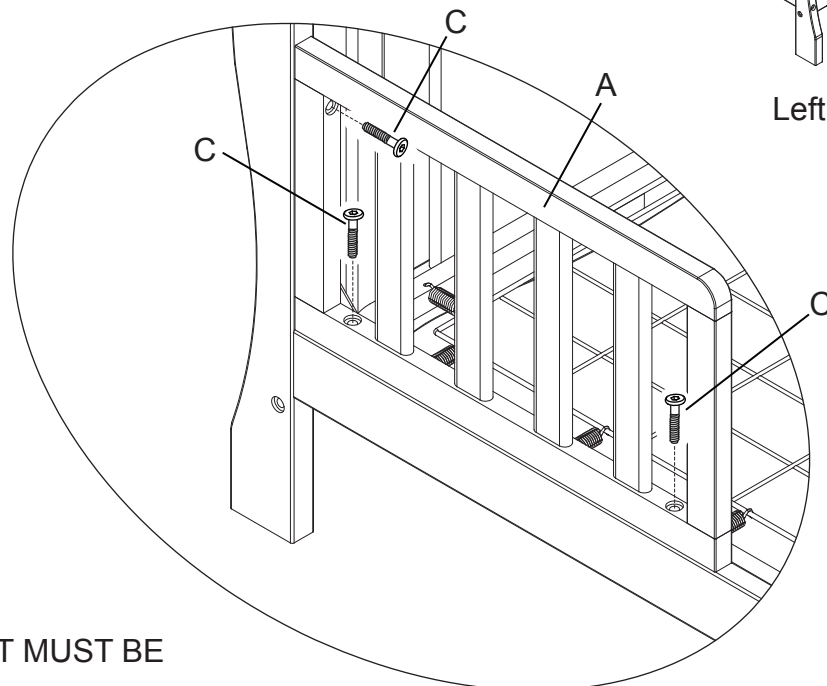

⚠ MATTRESS SUPPORT MUST BE
IN LOWEST POSITION.
STABILIZER BAR MUST BE USED.



Children's Products

Consumer Care:

www.DeltaChildren.com

Delta Children's Products

114 West 26th Street

New York, NY 10001

Tele.212-645-9033

Warranty: This Delta Product is warranted to be free from defects for a period of 90 days from the date of purchase under normal use. This warranty extends only to the original retail purchaser and is valid only when supplied with proof of purchase, or if received as a gift, when the registration is on file with Delta.

To register your product for important safety alerts and updates to your product please visit www.DeltaChildren.com

Please do not return this item to the store before contacting us about missing parts or with any questions.

To report a problem, please log on to www.DeltaChildren.com and click the Consumer Care Tab, or contact us by phone at (212) 645-9033.

In the event that you need to contact our customer service department please have the Style Number and Lot Number available. Use the space below to make note of those numbers. They can be found on the label on the bottom of Guard Rail.

STYLE No: 0089

COLOR

REV

FTY

Lot No. : _____

Pack Date: _____

Date of Purchase: _____ (you should also keep your receipt)