

CROSS COUNTRY ALL-TERRIAN JOGGING STROLLER



J is for Jeep[®]
Brand

INSTRUCTION MANUAL

ADULT ASSEMBLY REQUIRED
THIS PRODUCT CONTAINS SMALL PARTS
STYLES AND COLORS MAY VARY
11988

Fits Graco® SnugRide® Click Connect™ Infant Car Seat (not included)
Fits Evenflo® Embrace™ Select Infant Car Seat (not included)
Fits Evenflo® Nurture™ Infant Car Seat (not included)



Read all instructions BEFORE assembly and USE of product. KEEP INSTRUCTIONS FOR FUTURE USE.

WARNING

WARNING: Please follow all of these instructions to ensure the safety of your child. Keep these instructions for future reference.

WARNING: Failure to follow these instructions could result in serious injury or death.

WARNING: Avoid serious injury from falling or sliding out. Always insure that the child is properly positioned by using the safety harness according to these instructions.

WARNING: Never leave children unattended.

WARNING: FALL HAZARD from tip over. Before running, jogging, or walking fast, LOCK the front wheel from swiveling.

CAUTION: This is a single occupant jogging stroller for one child only. The use of more than one child may cause an unstable condition which can injure your child. Do not place parcels, diaper bags or accessory items on jogging stroller as this can cause an unstable condition.

- The maximum weight that can be carried in the lower basket, child tray and parent tray each is 3 lbs (1.36 kg).
- Before allowing the children near the stroller, be certain the stroller is fully erect and latched in the open locked position.
- Use of the stroller with children weighing more than 50 pounds (22.62 kg) or over 42 inches (106.7 cm) tall, may cause a hazardous unstable condition to the stroller.
- **NEVER** use the stroller on stairways.
- **NEVER** use the stroller in conjunction with bicycles, skateboards, roller skates, or in-line skates. Please discuss using the jogging stroller with your health care provider prior to jogging use. We recommend that the child occupant needs to be 6 months of age, at the minimum, before use of the stroller.

CARE AND MAINTENANCE

- To clean the stroller use a mild household soap with warm water on a sponge or clean cloth.
- Check your stroller for loose screws, worn parts, torn material or stitching on a regular basis. Replace or repair parts as needed.
- Discontinue use of stroller if it should become damaged or malfunctions. Please contact our customer service number 1-800-377-3777 to arrange for repair or obtain replacement parts.
- If you experience any difficulty with assembly, missing parts or use, please DO NOT return this item to the store. Retail stores are unable to properly assist you. Contact our Customer Service Department directly for assistance 1-800-377-3777.

PARTS

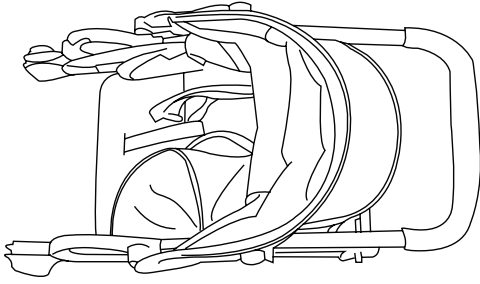

Stroller



Front Wheel Axle Lock Nuts



Front Wheel Retainer Plate

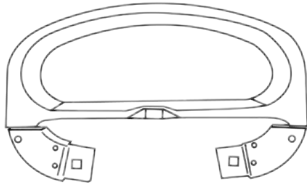

Child Tray

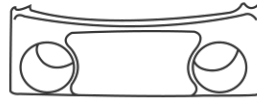

Parent Tray

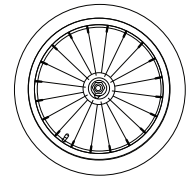

Front Wheel

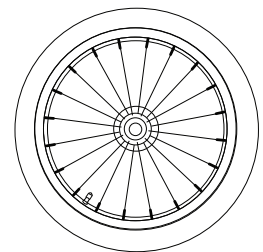
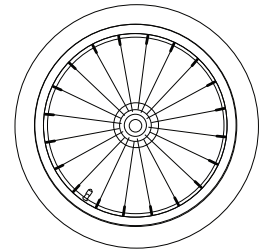

Rear Wheels

ASSEMBLY

IMPORTANT! To ensure safe operation of your stroller, please follow these instructions carefully. Please keep these instructions for future reference.

IMPORTANT! Before assembly and each use, inspect this product for damaged hardware, loose joints, missing parts or sharp edges. NEVER use stroller if any parts are missing or broken. **IMPORTANT!** Adult assembly is required.

- Remove stroller from box. The front wheel, rear wheels, parent tray and child tray need to be installed prior to use.

FRONT WHEEL

WARNING: This front wheel utilizes a front wheel axel lock nut system. Please follow all of these instructions to ensure the safety of your child. Failure to follow these instructions could result in serious injury or death.

- To attach the front wheel, unfold stroller as described in the following section:

-
1. Lean the stroller backwards so the rear axle frame is resting on a flat surface and the front wheel forks are pointing upward. (Fig. 1)
-

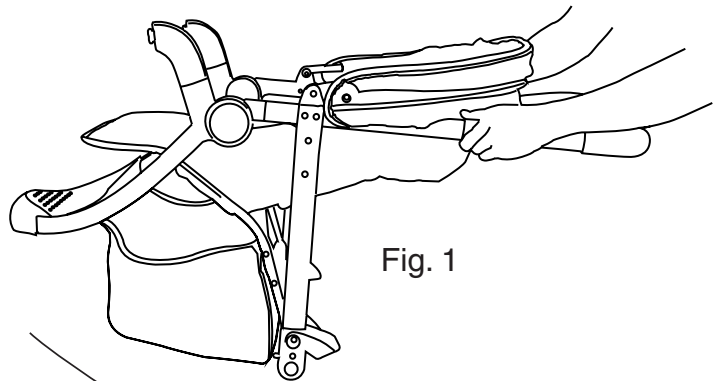

2. Hook the front wheel axle into the front fork's slots (Fig.2)

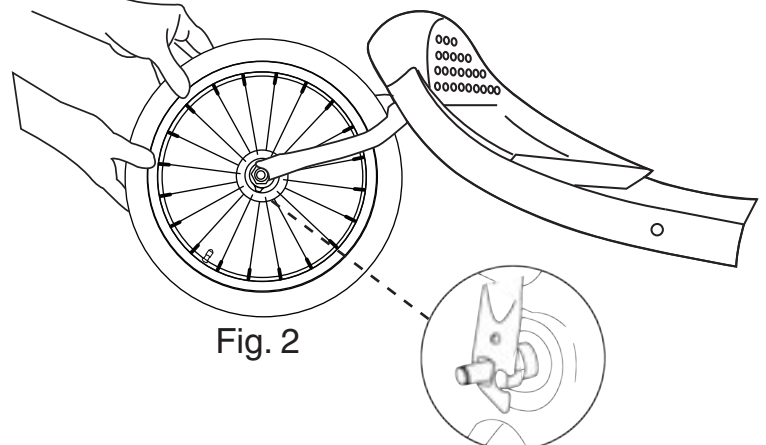

ASSEMBLY

- Slide the retainer plate onto the front wheel axle. Be sure that the retainer plate's bent tab is facing towards the front fork slot. The bent tab on the retainer plate must be lined up with and trapped inside the front fork slot before tightening the wheel. (Fig. 3)

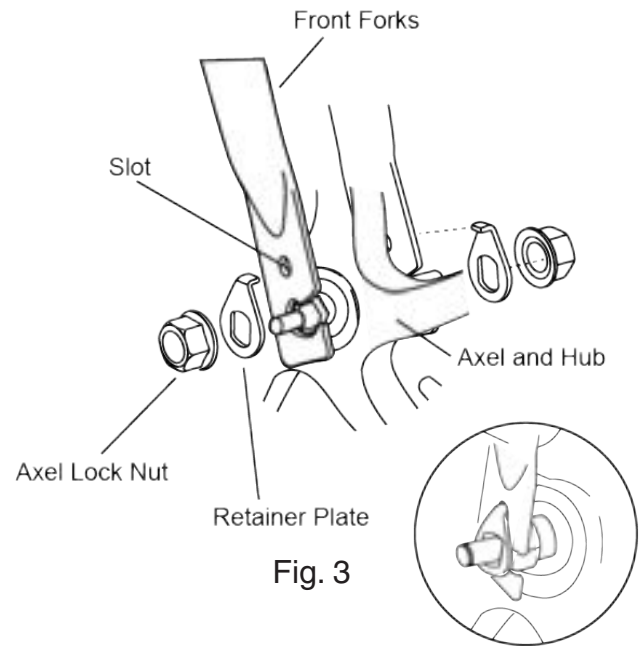

Fig. 3

- Install the axel lock nuts and tighten with standard wrench, box or open end wrench. The front axel lock nut will be fully tighten and securely fastened when there is significant resistance to front fork. Repeat on other side. The wheel should be held tightly in place (Fig. 4).

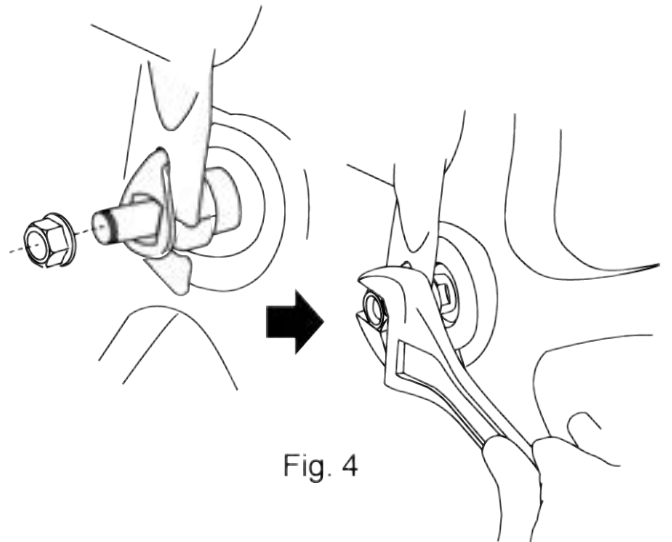

Fig. 4

TESTING FOR PROPER WHEEL INSTALLATION

WARNING:

FALL HAZARD

Wheel can detach and cause tip over. Pull on the wheel to assure it is securely attached and make sure the front swivel wheel is in a locked position during running, jogging or walking fast.

WARNING: ALWAYS check that both front axel lock nuts are fully tighten before each use to ensure that the front wheel is securely fastened to the frame.

ASSEMBLY

5. Lift the front wheel off of the ground and sharply strike the top of the tire. (Fig. 5) The wheel should not be loose or come off.

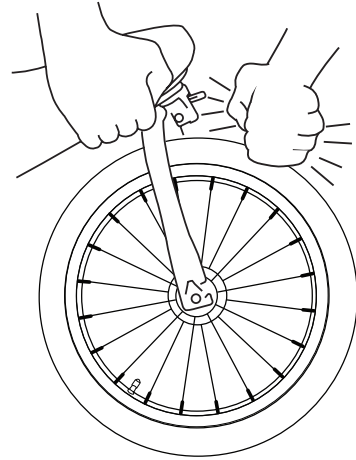

Fig. 5

REAR WHEEL

6. To attach the rear wheels, lay stroller on its side. Align back wheel axle to the stroller's rear wheel axle housing (Fig 6a). Push the back wheel axle inward until you hear a "click" (Fig. 6b). Once in a fully locked position, check to make sure back wheel is in a fully locked position by pulling outward. Repeat steps for other side back wheel. NEVER use stroller if any wheels are not in a fully locked position. Please contact our customer service department immediately at 1-800-377-3777 for assistance.

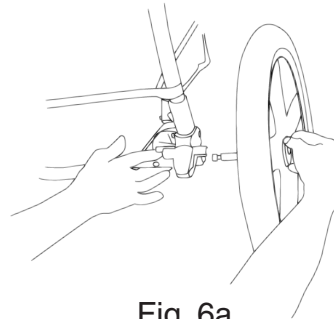

Fig. 6a

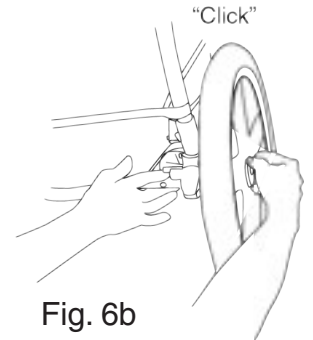

Fig. 6b

PARENT TRAY

WARNING: The maximum weight that can be carried in the parent tray is 3 lbs (1.36 kg). NEVER place hot liquids in the parent tray as can cause serious burns and NEVER place more than 3lbs (1.36kg) in parent tray as may cause an unstable condition.

ASSEMBLY

7. To attach parent tray align left and right side holes in tray to metal post on outside of handle. Pop tray over metal posts for a fully locked position. When posts are completely enclosed through parent tray holes, pull upward to check for a fully locked position (Fig 7).

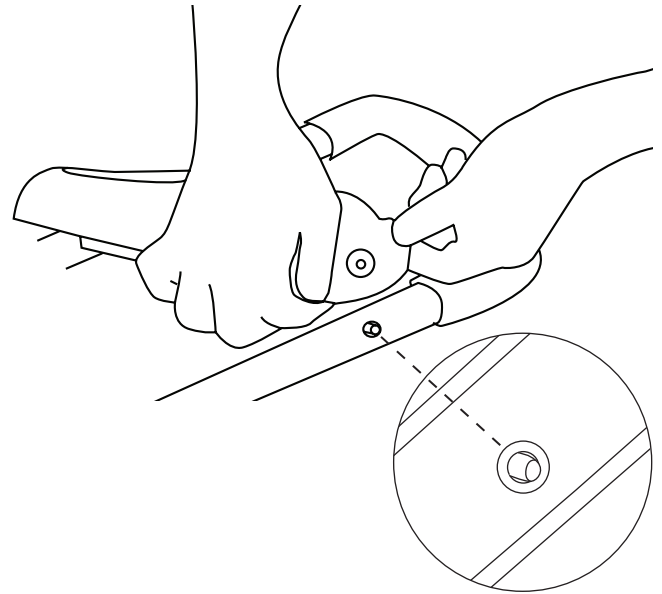

CANOPY

8. To open the canopy: pull forward on the front edge of the canopy until fully opened. (Fig. 8)
To close canopy: push backward on front edge until canopy is all the way collapsed. (Fig. 9)



Fig. 8

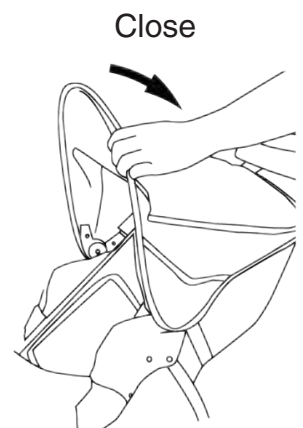

Fig. 9

ASSEMBLY

SUN VISOR

9. To open the sun visor: grab front edge of sun visor under canopy and pull down and rotate forward until fully extended. (Fig. 10)

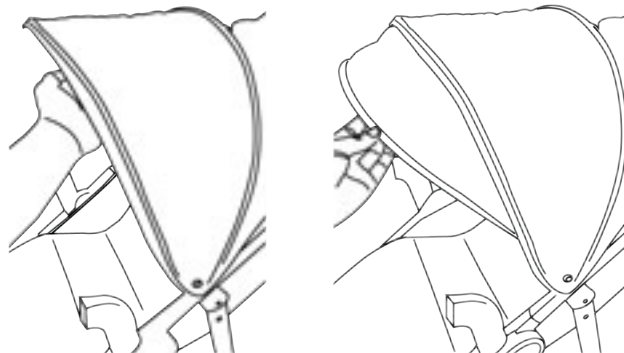

Fig. 10

CHILD TRAY

10. To attach the child tray: Rotate and align left and right side of child tray posts with the left and right side stroller tray posts. Press left and right side child tray posts into left and right side stroller tray posts into a fully locked position. Press left side child tray button and snap child tray onto stroller tray posts. Release button to lock child tray onto stroller (Fig.11). Repeat on right side of child tray. Check to make sure the child tray is securely attached to the stroller by pulling upward on the child tray.

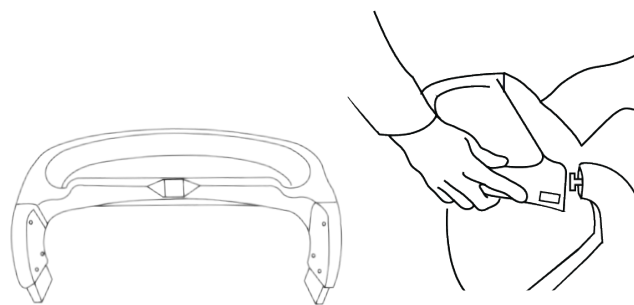

Fig. 11

11. To access child seat: press left or right release buttons (Fig 12) and rotate tray upward (Fig 12a).



Fig. 12

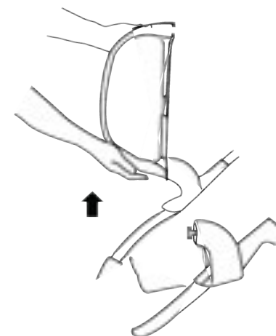

Fig. 12a

ASSEMBLY

12. To remove the child tray: Press the right and left release buttons and pull upward on child tray. (Fig 13)

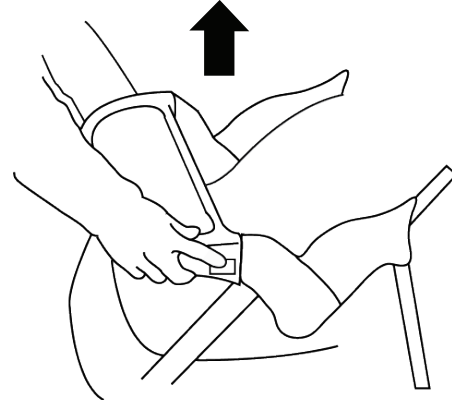

Fig. 13

SAFETY

BRAKES

WARNING: Always lock brakes when not in use on a hill or incline as stroller may roll away or slide down the hill.

WARNING: Never leave child unattended in stroller.

13. To lock brakes, press downward on brake lever located on each rear wheel. Please note in order to line up the break tab with brake tab slots stroller may need to be moved forward or backwards slightly. (Fig. 14) Check to make sure the brakes are in a fully locked position, so stroller will not move when pushed. To release breaks, gently push up on the brake lever.

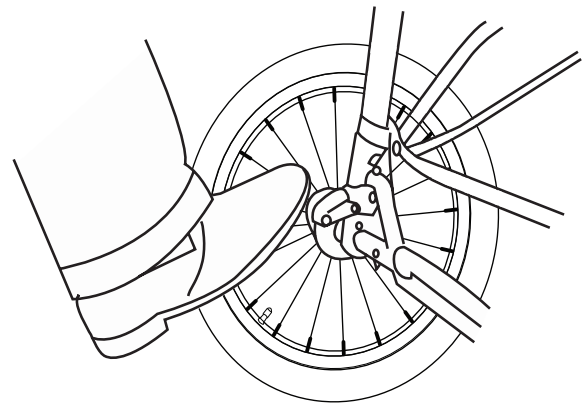

Fig. 14

SAFETY

TO SECURE THE CHILD

WARNING: Avoid serious injury from falling or sliding out. Always use the safety harness.

STRANGULATION HAZARD: Child can strangle in loose straps. Never leave child in seat when straps are loose or undone.

14. Place your child in the stroller. Position the crotch belt between your child's legs. Pull shoulder straps over child's arm and shoulder and fasten both strap ends to the restraint system. Fasten both waist belts to the buckle on each side of the crotch belt. Make sure you hear a "click" on both sides. Check to be sure the restraint system is securely attached by pulling it away from your child. The restraint system should remain attached. (Fig 15)

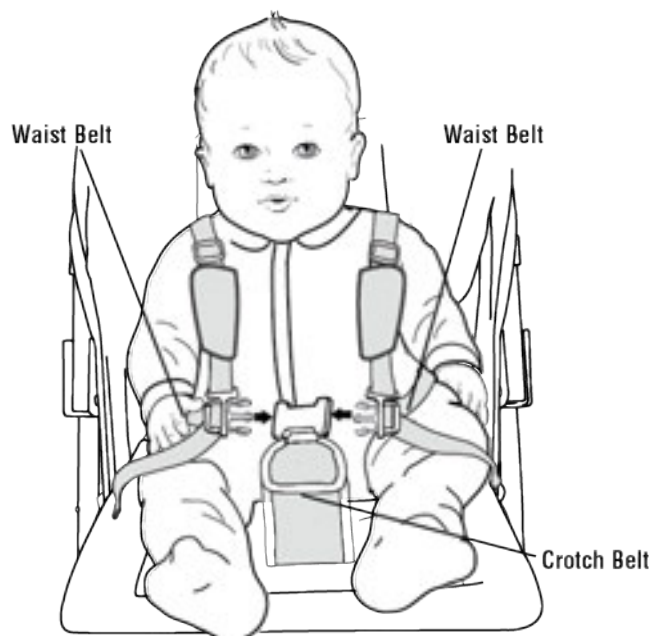

Fig. 15

15. To release, apply pressure to both sides of locked clips until clip releases. See (Fig. 16). This might need a considerable amount of effort to release as this harness is to prevent an accidental release by your child.

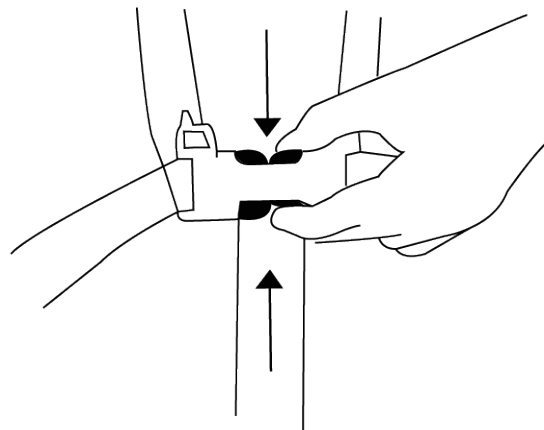

Fig. 16

SEAT BACK RECLINE POSITIONING

16. Press buttons on each side cord housing and pull away to recline seat (Fig 17). To return to an upright position, hold cord loop while pressing buttons on each side of cord housing and move cord housing towards the backseat.

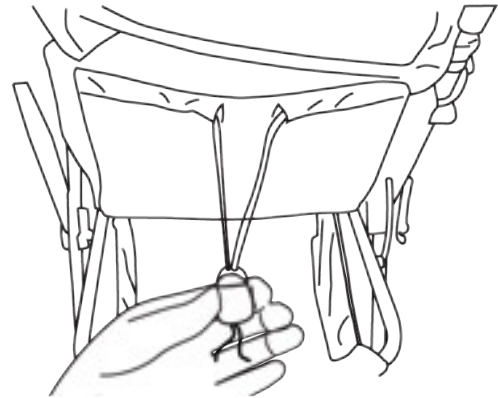

Fig. 17

HOW TO ATTACH CAR SEATS

17. To use the car seat feature, lock back wheels and recline the back seat to its lowest point and fold canopy close. Turn and lock grey latches (Fig 19). Align car seat as shown in Fig 18. Angle feet first, while lowering car seat into a locked position on the child tray.



Fig. 18

Fig. 19

18. Final step to secure the footrest side of car seat onto the stroller, use the straps with velcro to secure seat onto stroller. (Fig 19a). Check that car seat is securely attached by pulling up on the car seat. To remove, undo latches and unlock car seat from childtray.

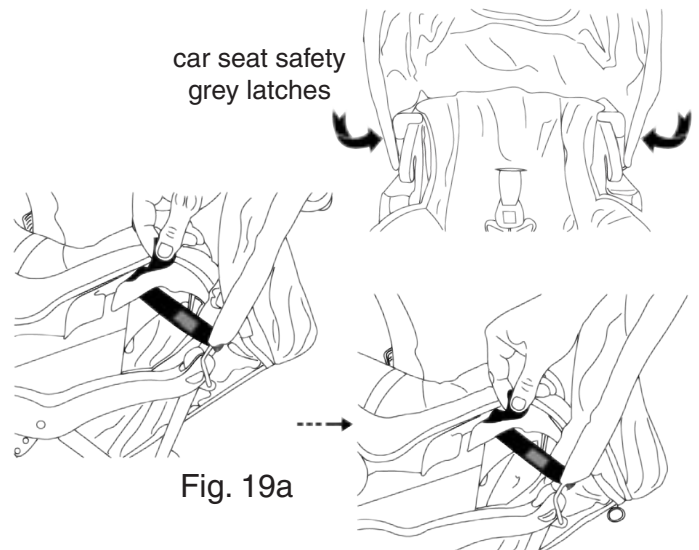

Fig. 19a

JOGGING WITH YOUR STROLLER

19. When you are jogging with your child, use the following safety features:

- LOCK THE FRONT SWIVEL WHEEL IN STRAIGHT POSITION
- SAFETY TETHER STRAP: Always connect the safety tether strap to either right or left wrist when jogging. The tether strap will keep the stroller from moving or rolling away in the event that you trip or stumble while running. (Fig. 20) The safety tether strap must remain connected to the rear lower frame cross member at all times. The safety tether strap can be stored on the left or right side of the stroller with the Velcro attachment, when not in use. (Fig 20a).
- NOTE: Do not remove the safety tether strap from the bottom wheel axle as it is intended to prevent the stroller from tipping backwards if the stroller happens to move or roll away in the event that you trip or stumble.

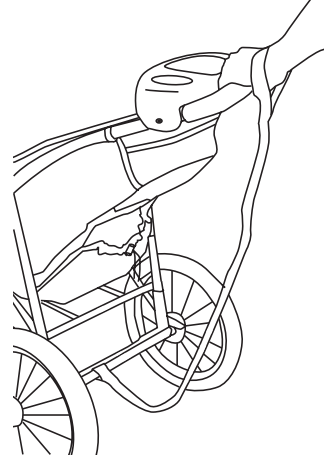

Fig. 20

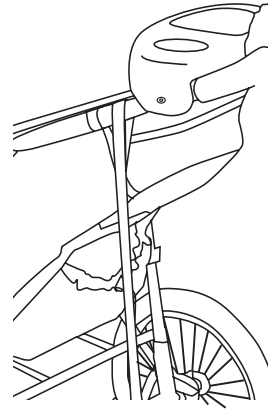

Fig 20a

TO FOLD STROLLER

WARNING: Care must be taken when folding and unfolding the stroller to prevent finger entrapment.

20. Close the canopy as described in the canopy section (Fig 8-9). Recline seat by releasing buckle as described in seatback positioning section (Fig 17).

- The stroller is folded by simultaneously pulling each trigger fold located on right and left handle above the canopy (Fig. 21a). When the fold latches are released, the handle will begin to rotate and lower toward the floor.

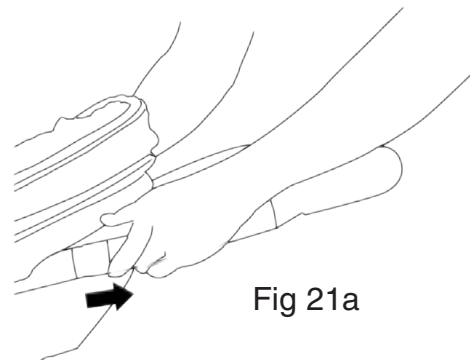

Fig 21a

SAFETY

- Release the fold buttons and move handle downward until the stroller is completely folded. The stroller is in a fully locked position when the locking fold latch is locked over the “T” post, located on the right side of the stroller (Fig. 21b).

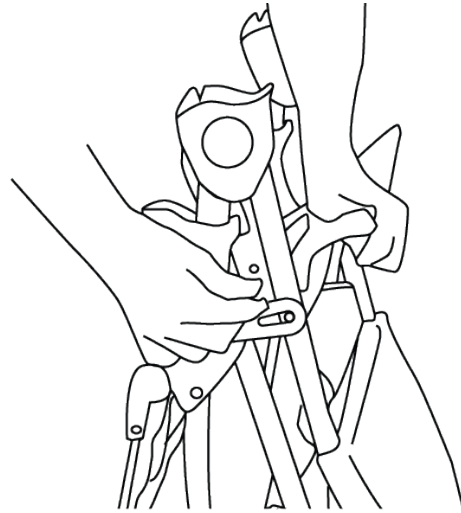

Fig 21b

TO UNFOLD STROLLER

WARNING: Care must be taken when folding and unfolding the stroller to prevent finger entrapment.

21. Place the stroller on the ground with all three wheels touching the ground. Release the locking folding latch, which is located on the right side. (Fig. 22a)

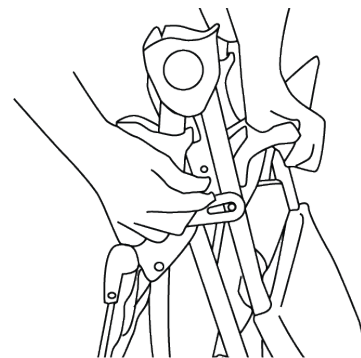

Fig 22a

- Lift up on the stroller handle with both hands until the stroller frame is in a fully opened and locked open position. (Fig. 22b) The stroller is in a fully locked position when both side handle latches are in a fully locked position. Prior to placing your child into the stroller, test to make sure both latches are fully engaged and fully locked.

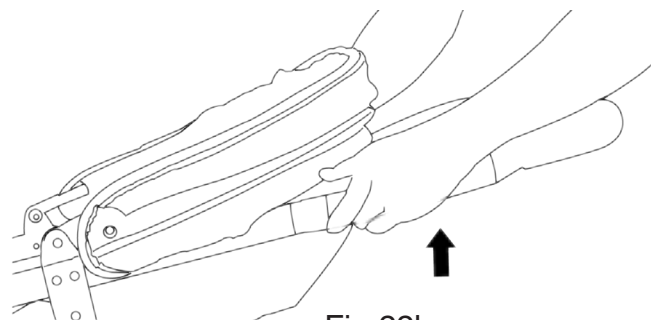

Fig 22b

OTHER

FLAT TIRE

The jogging stroller features bicycle air tires which could become flat. If you have a flat tire, use a standard bicycle hand air pump to inflate the tires. Inflate the tires 20-25 psi.

NOTE: The stroller air tires can be taken to a bicycle shop for flat tire repair.



Delta Childrens Products Corp.
114 West 26th Street
New York, NY 10001
1-800-377-3777
www.deltachildren.com