

ALPHA ELITE STROLLER

11504-XXX AESV1

**ASSEMBLY INSTRUCTIONS
ADULT ASSEMBLY REQUIRED**



Styles and colors may vary



**IMPORTANT: Read all instructions before assembly and use of the product.
Keep the instructions for future reference.**

Customer Care Tel. 1-(800)-377-3777

(A)

www.DeltaChildrensProducts.com

DCP Cat # 05-29-13-V1

Consumer Information



WARNING

Prevent serious injury from falls or sliding out:

- ALWAYS use the restraint system.
- Only children who have developed enough upper body control to sit without leaning forward can use the front seat in the upright position.
- NEVER leave child unattended.
- DO NOT use the storage bag to carry children.

To prevent product from tipping over:

- DO NOT exceed the maximum storage weight limit of 3 lbs (1.36 kg) in the storage bag.
- DO NOT exceed the maximum storage weight limit of 3 lbs (1.36 kg) in the cup holder.
- DO NOT place additional items on this product, except as recommended in the instructions.

To prevent injury:

- Make sure all body parts are clear of the stroller when folding and unfolding.
- DO NOT place hot liquids in the cup holder. Hot liquids can burn your child.

- Please read these instructions before assembly and use of this product.
- Adult assembly is required.
- Use only for a child who weighs less than 45 lbs (20.41 kg).
- Maximum weight limit for the storage bag is 3 lbs (1.36 kg).
- Maximum weight limit for the cup holder is 3 lbs (1.36 kg).
- Product features and decorations may vary from the photo.

Care

- The plastic parts may be wiped clean using a mild cleaning solution and damp cloth. Hand wash fabric with damp cloth and air dry. Do not use bleach.
- To keep your stroller wheels from squeaking, use a silicone or graphite based lubricant.

Manufactured for and distributed by:

Delta
Children

114 West 26th Street, New York, NY 10001



Customer Service

Tel. 1-(800)-377-3777

www.DeltaChildrensProducts.com

customerservice@DeltaChildrensProducts.com

MADE IN CHINA

Parts

IMPORTANT! Please remove all parts from the package and identify them before assembly.

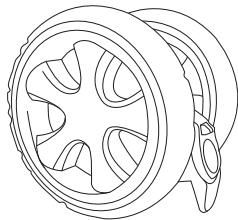
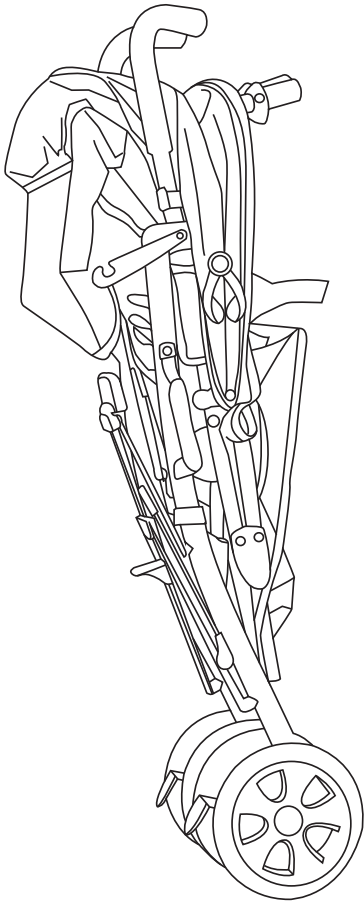

**Front Swivel
Wheels X 2**

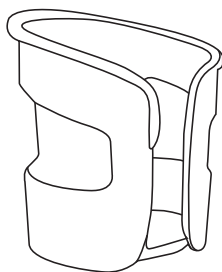

Cup Holder

Assembly

IMPORTANT! Before assembly or each use, inspect this product for damaged hardware, loose joints, missing parts or sharp edges. DO NOT use if any parts are missing or broken. Contact manufacturer for replacement parts and instructions if needed. Never substitute parts.

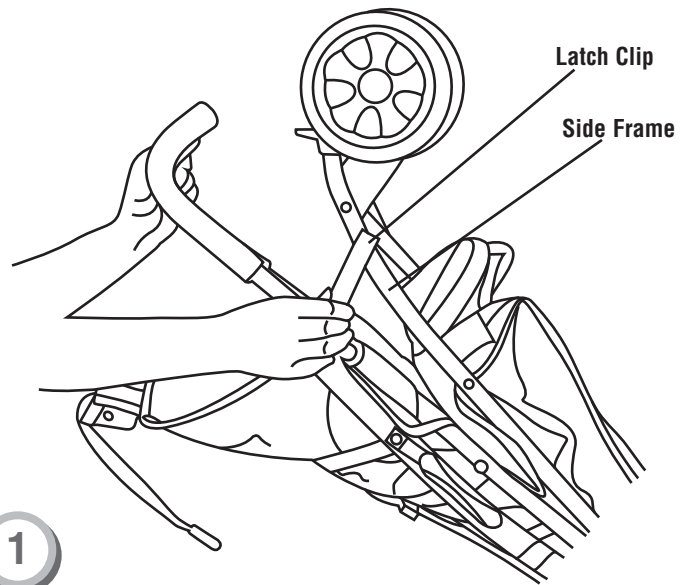

- Locate the latch clip on the side frame of the stroller.
- Pull to release the latch clip.

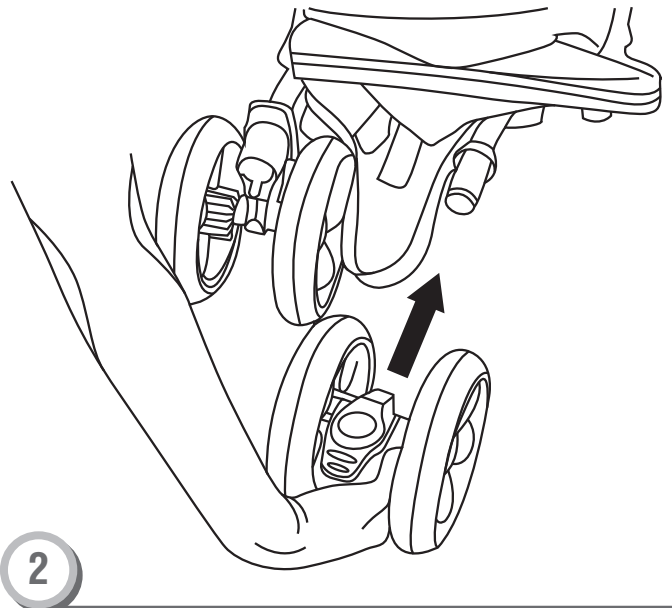

Attaching Front Swivel Wheels

- Locate the legs on the front of the stroller. (as pictured above)
- Attach wheel unit to the front of the stroller leg, make sure you hear a “snap”.
- Check to make sure the wheel units are properly attached.
- Repeat on opposite side.

Assembly

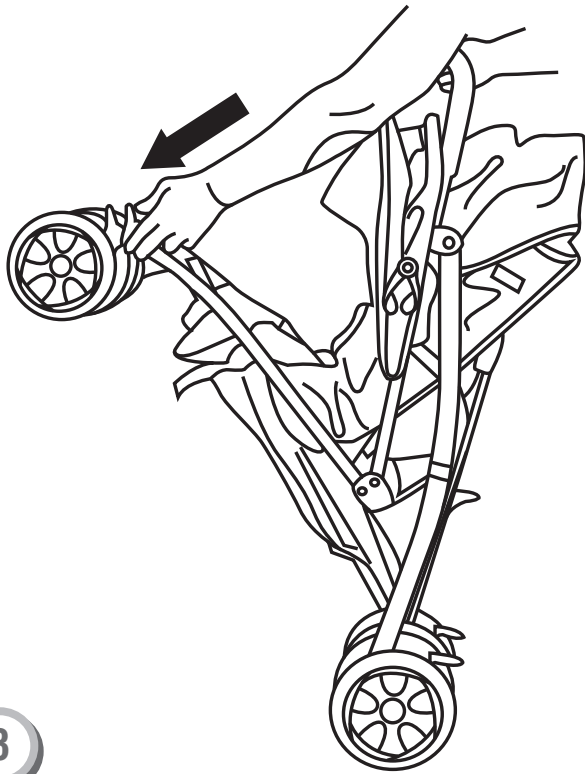

3

- Position the stroller upright on its rear wheels.
- Grasp a handle with one hand. With your other hand, push down on the front of the stroller to open.

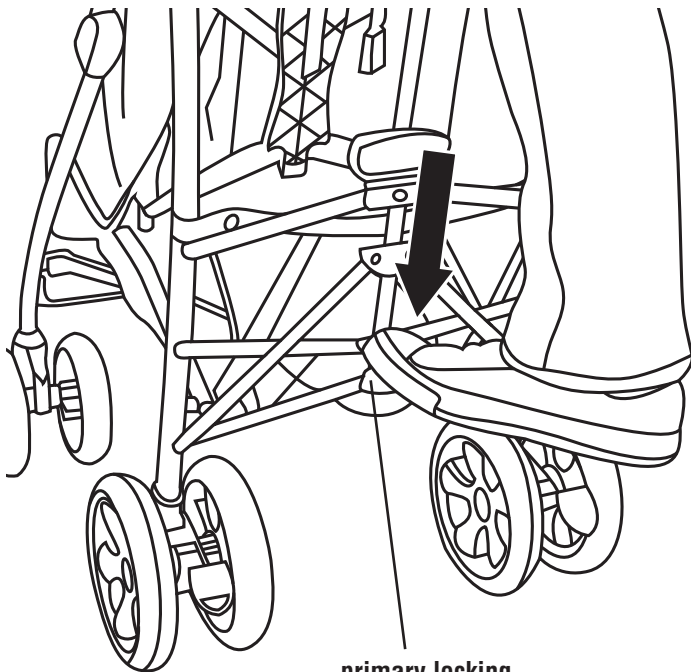

primary locking mechanism

4

Opening Stroller

- With your hand around the grip, press down on the primary locking mechanism until it **“clicks”** into place.
- Release the secondary lock, by pressing the pedal placed on the right side of the stroller's frame with your foot.

Setup and Use

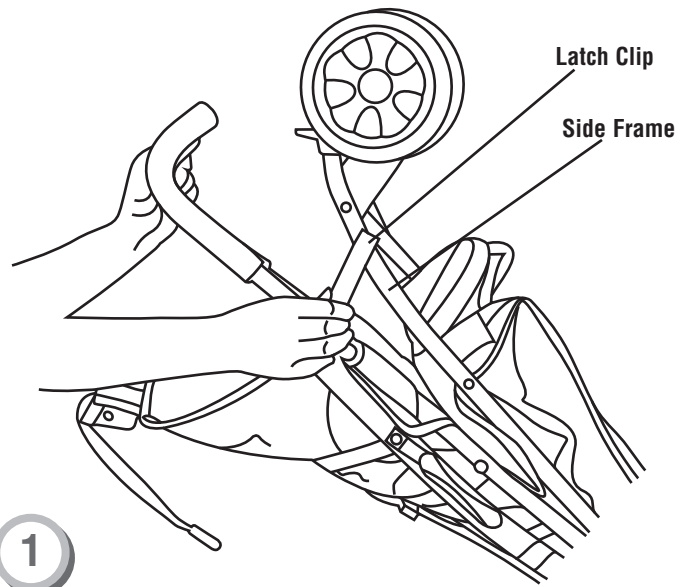

1

To Unfold

- Locate the latch clip on the side of the stroller.
- Pull to release the latch clip on the side of the stroller.

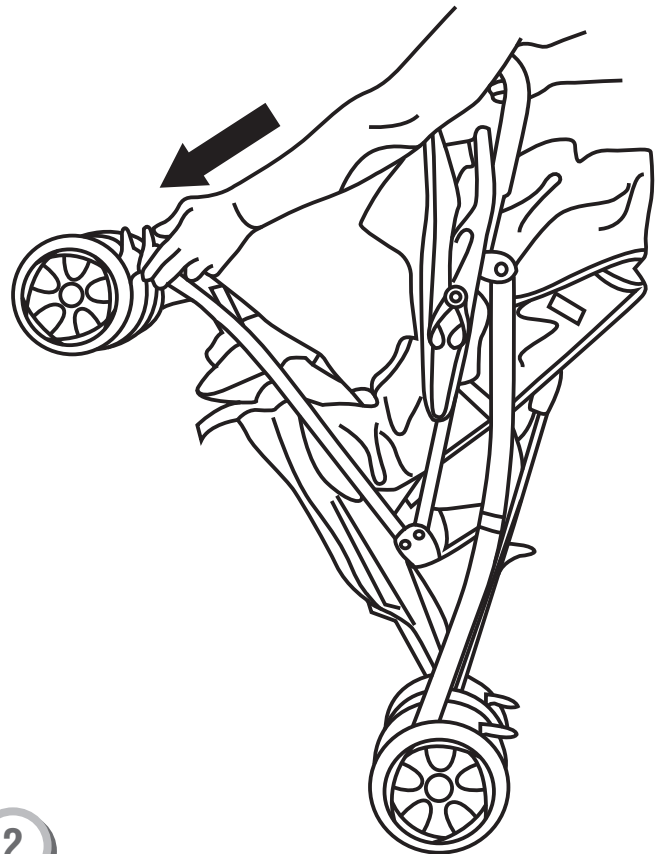

2

- Position the stroller upright on its rear wheels.
- Grasp a handle with one hand. With your other hand, push down on the front of the stroller to open.

Setup and Use

WARNING

Prevent serious injury from falls or sliding out:

- ALWAYS use the restraint system.
- Only children who have developed enough upper body control to sit without leaning forward can use the front seat in the upright position.
- NEVER leave child unattended.
- DO NOT use the storage bag to carry children.

To prevent product from tipping over:

- DO NOT exceed the maximum storage weight limit of 3 lbs (1.36 kg) in the storage bag.
- DO NOT exceed the maximum storage weight limit of 3 lbs (1.36 kg) in the cup holder.
- DO NOT place additional items on this product, except as recommended in the instructions.

To prevent injury:

- Make sure all body parts are clear of the stroller when folding and unfolding.
- DO NOT place hot liquids in the cup holder. Hot liquids can burn your child.

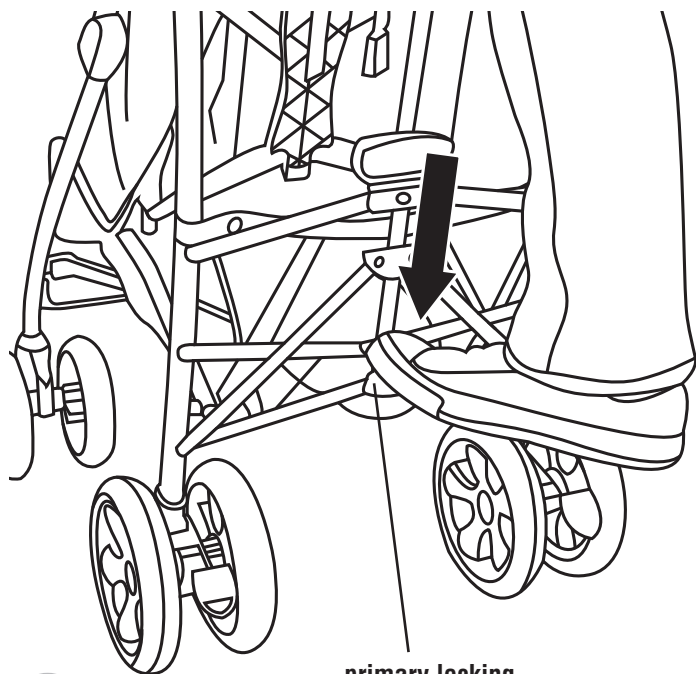

4

primary locking mechanism

Opening Stroller

- With your hand around the grip, press down on the primary locking mechanism until it “clicks” into place.
- Release the secondary lock, by pressing the pedal placed on the right side of the stroller’s frame with your foot.

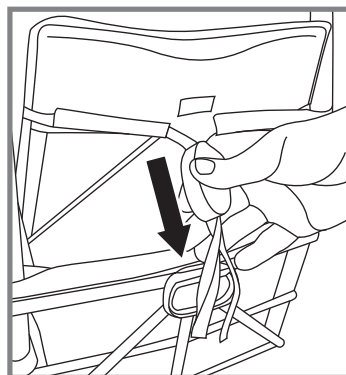

RECLINE

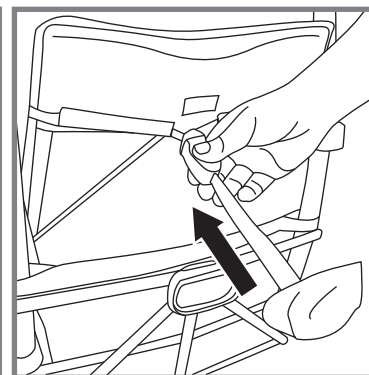

UPRIGHT

5

Seat Back Adjustment

- Press button on cord housing and pull away to recline seat, as shown in fig. 1.
- To return to an upright position, hold cord loop while moving cord housing towards the backseat.

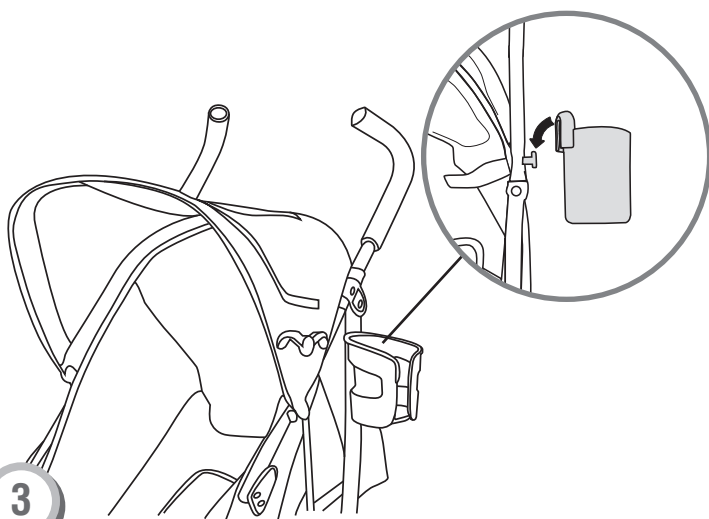

Attaching Cup Holder

- Locate the knob on the side of the stroller.
- Fit the notch in the cup holder over the knob on the side rail and push down until you hear a “click”. Pull up on the cup holder to be sure it is secure.

Setup and Use

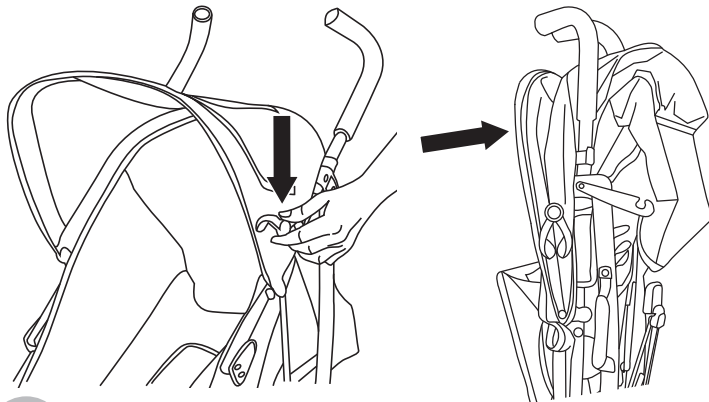

6 CANOPY OPEN

CANOPY CLOSED

Canopy Adjustment

- The canopy can be adjusted to the open or closed position.

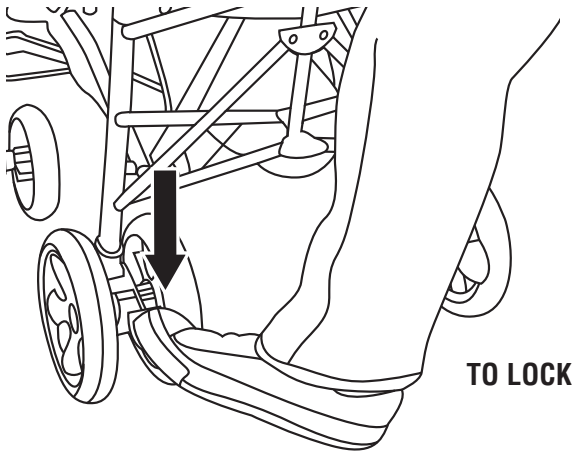

TO LOCK

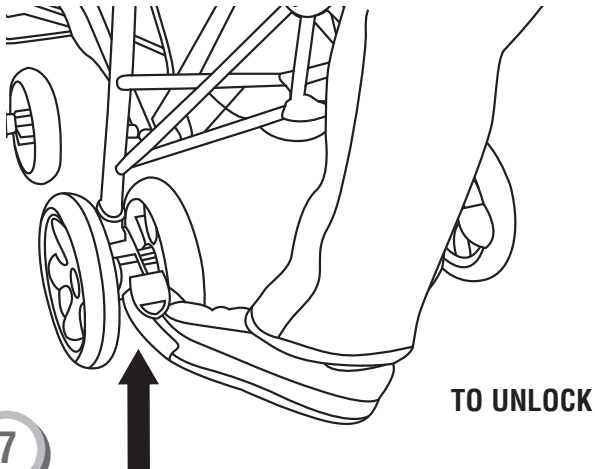

TO UNLOCK

7

Rear Wheel Brakes

To lock the rear wheel brakes:

- Press **both** brake pedals down until they “click” into the locked position.
Make sure the brake pedals are pressed down completely.
- Always set both brake pedals whenever you park the stroller.

To unlock the rear wheel brakes:

- Lift both brake pedals until they “click” into the unlocked position.

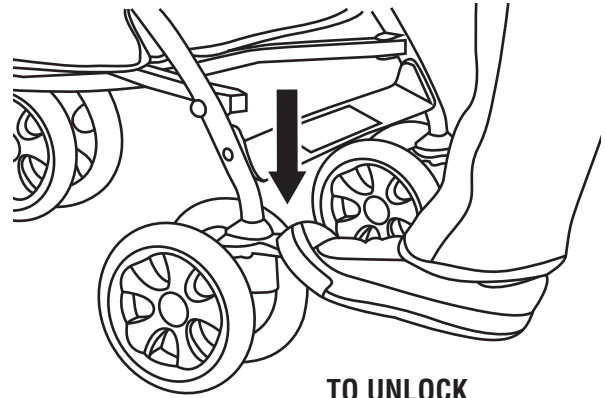

TO UNLOCK

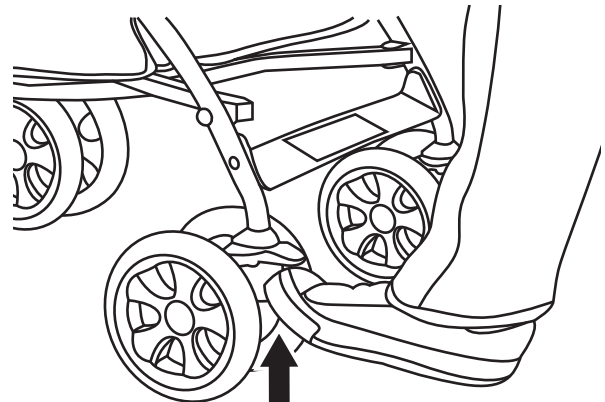

8

TO LOCK

Front Swivel Wheel base

To lock the swivel wheel base:

- Lift **both** swivel pedals until they “click” into the locked position.

Make sure the brake pedals are pressed down completely.

To unlock the swivel wheel base:

- Press both swivel pedals down until they “click” into the unlocked position.

Securing Child

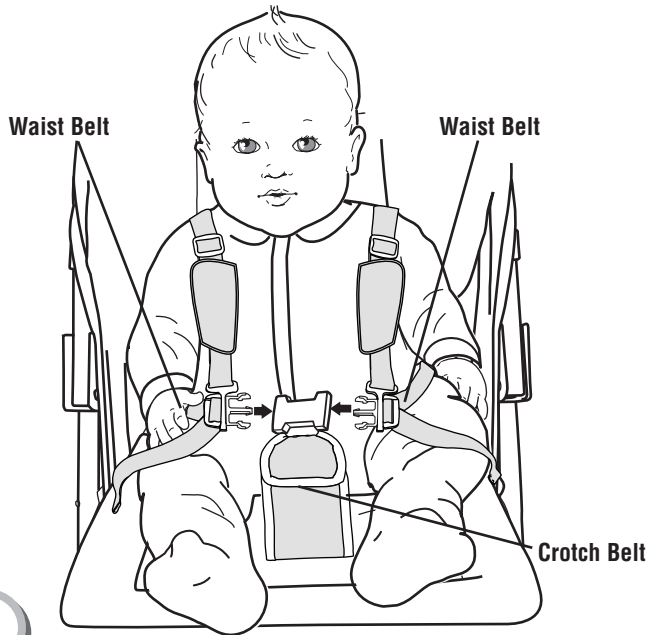

1

Securing Child

- Place your child in the stroller. Position the crotch belt between your child's legs.
- Pull shoulder straps over child's arm and shoulder and fasten **both** strap ends to the restraint system.
- Fasten **both** waist belts to the buckle on each side of the crotch belt. Make sure you hear a "click" on both sides.
- Check to be sure the restraint system is securely attached by pulling it away from your child. The restraint system should remain attached.

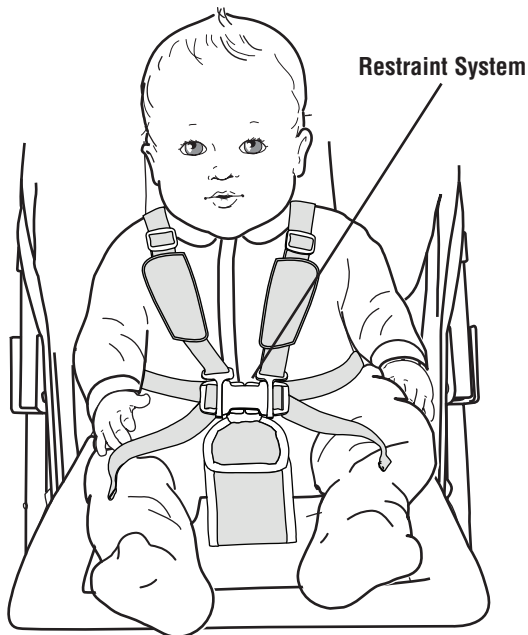

2

- Tighten each waist belt and shoulder strap so that the restraint system is snug against your child.
Please refer to the next section for instructions to tighten the waist belts.

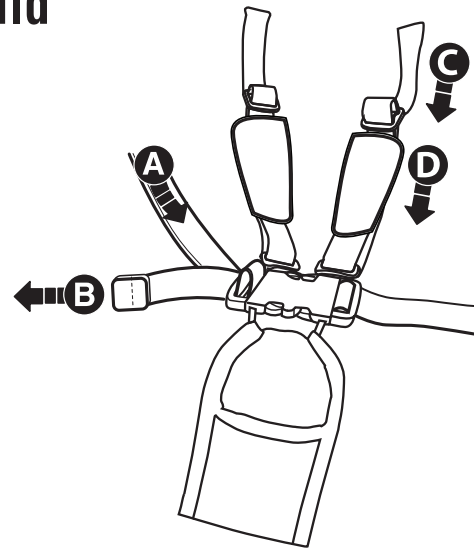

TIGHTEN

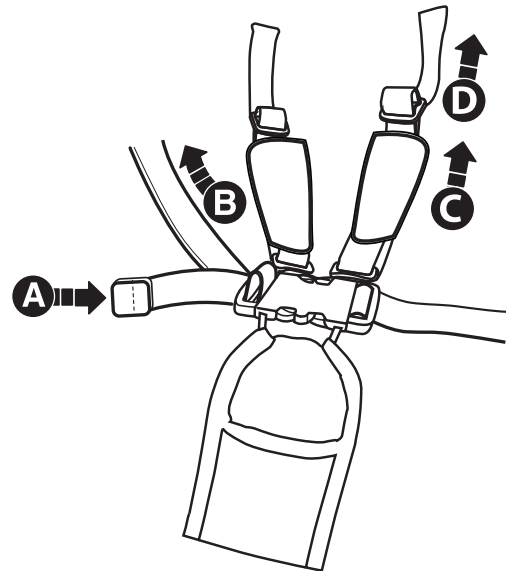

LOOSEN

3

To tighten the waist belts and shoulder straps:

- Feed the anchored end of a waist belt up through the buckle to form a loop **A**. Pull the free end of the waist belt **B**.
- Repeat this procedure to tighten the other waist belt.
- Feed the top end of the shoulder strap through the plastic stay to form a loop **C**. Pull the bottom end down to tighten the strap **D**.
- Repeat this procedure to tighten the other shoulder strap.

To loosen the waist belts and shoulder straps:

- Feed the free end of the waist belt up through the buckle to form a loop **A**. Enlarge the loop by pulling on the end of the loop toward the buckle. Pull the anchored end of the waist belt to shorten the free end of the waist belt **B**.
- Repeat this procedure to loosen the other waist belt.
- Feed the bottom end of the shoulder strap through the plastic stay to form a loop **C**. Pull the top end up to loosen the strap **D**.
- Repeat this procedure to loosen the other shoulder strap.

Please note: After adjusting the restraint system to fit your child, make sure you pull on it to be sure it is securely fastened.

Storage

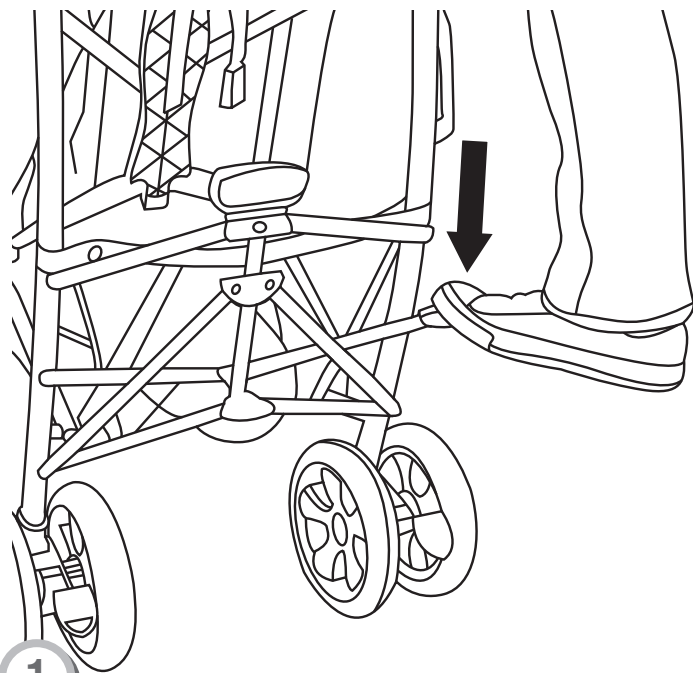
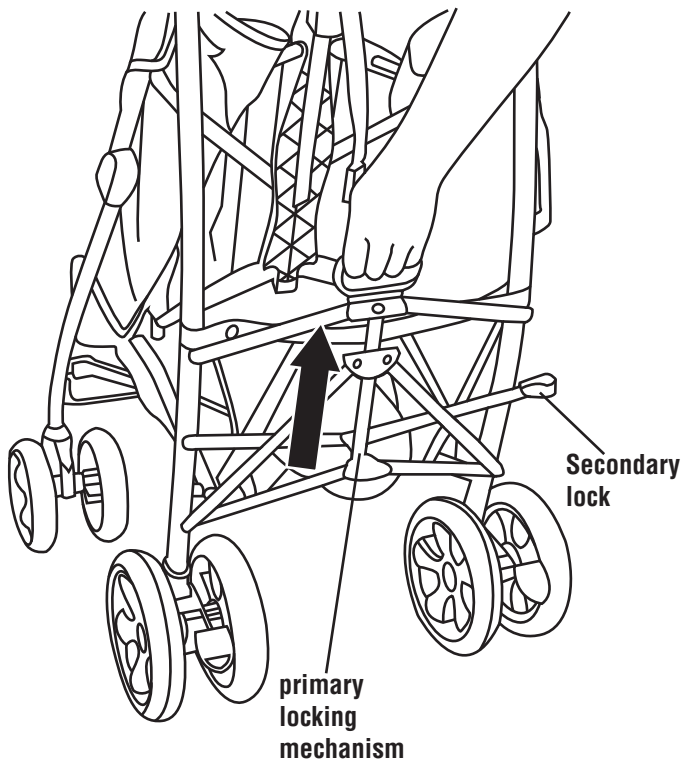

Hint: Make sure canopy is in the closed position before folding the stroller.

- With your hand, pull up on the primary locking mechanism.
- With your foot, step on the secondary lock.

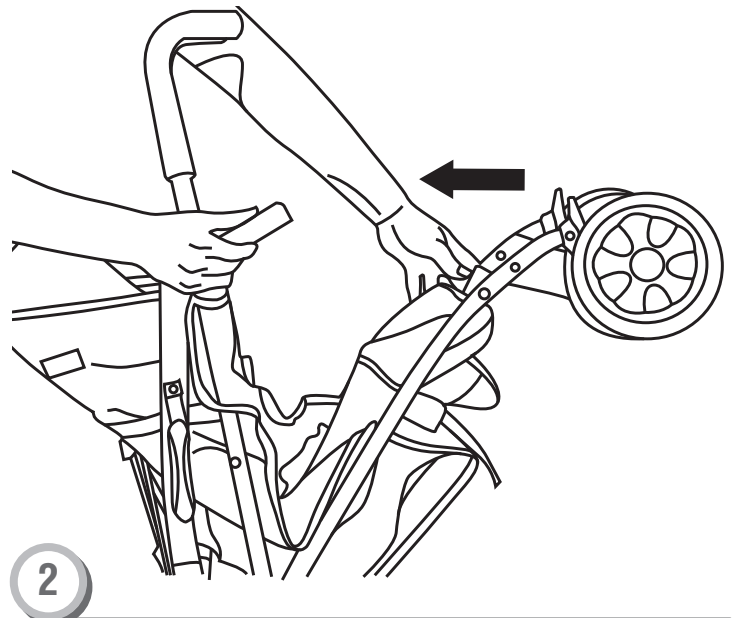

- Lift the front wheels toward the closed canopy.

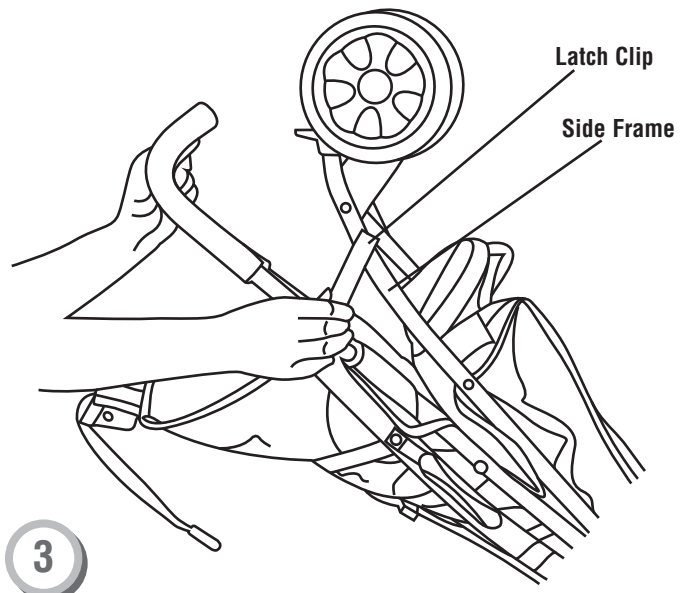

- Slide the latch clip onto the side frame to secure in the folded storage position.

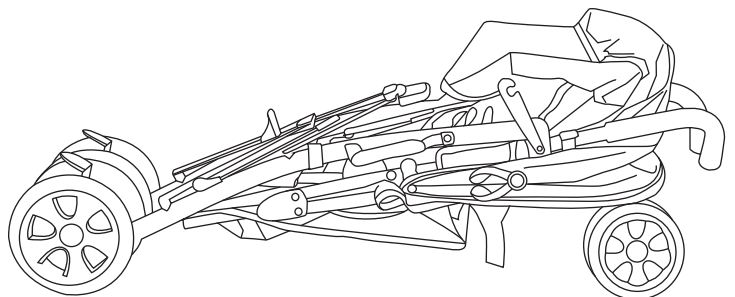

- Storage position.

Manufactured for and distributed by:



114 West 26th Street, New York, NY 10001



Customer Service

Tel. 1-(800)-377-3777

www.DeltaChildrensProducts.com

customerservice@DeltaChildrensProducts.com

MADE IN CHINA