



NUMBER	WEIGHT	TOLERANCE UNLESS OTHERWISE SPECIFIED	 <b>VT Hackney</b> A company of VT Systems 252-946-6521 hackney.com vtvisioncomms.com
PARTS	389.266	.XX = +/- .060 .XXX = +/- .030	
ROUTING	MATL CODE	DESCRIPTION	 <b>VISIONCOMMS</b> A company of VT Systems visioncomms.com
FINAL	ZA	0.000	
ITEM NO	SHRPE DESC	DATE	<b>SHELF ASSEMBLY LH - P2000 14' STD</b>
374529		15-Mgy-12	
REV/MATL	RHS	DATE	
DRAWN BY			
LCS			
APPROVED BY			
SUPERSEDES			
		SCALE	0.100
		DRG-NAME	P12C0311 Sheet 1 of 4



DETAIL F  
SCALE 0.500

<b>Hackney</b>		<b>VT Hackney</b>		<b>Kibron</b>	
A company of VT Systems		A company of VT Systems		A company of VT Systems	
252-946-8521		252-946-8521		252-946-8521	
hackney.com		hackney.com		kibron.com	
vtvisioncomms.com		vtvisioncomms.com		vtvisioncomms.com	
VISIONCOMMS		VISIONCOMMS		VISIONCOMMS	
DESCRIPTION		DESCRIPTION		DESCRIPTION	
SHELF ASSEMBLY LH - P2000 14' STD		SHELF ASSEMBLY LH - P2000 14' STD		SHELF ASSEMBLY LH - P2000 14' STD	
WEIGHT	389.266	TOLENANCE UNLESS OTHERWISE SPECIFIED	.XX = +/- .060	SCALE	0.100
PARTS			.XXX = +/- .030	DATE	
ROUTING	ZA			APPROVED BY	
FINAL				SUPERSEDED BY	
ITEM NO	374529				
TRM-MATL					
DATE	15-May-12				
APPROVED BY					
SUPERSEDES					

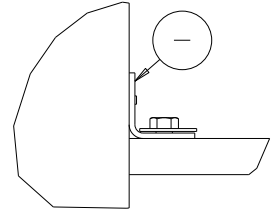
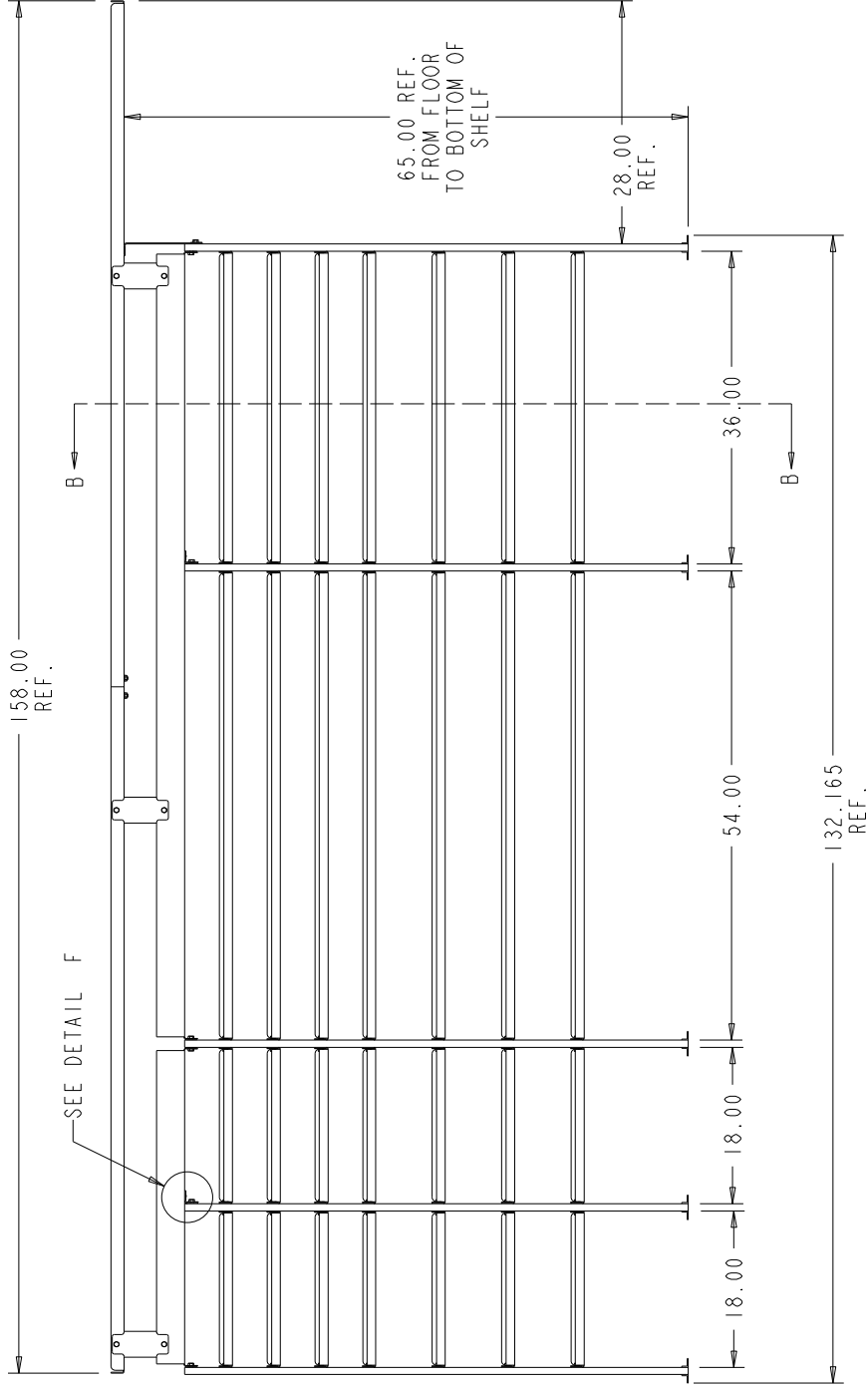
# ATTACHMENT DETAILS

**NOTES:**

CUSTOMER IS RESPONSIBLE FOR ADEQUATE ATTACHMENT TO BODY.  
 ATTACHMENT HARDWARE IF REQUIRED IS TO BE PROVIDED BY THE CUSTOMER.

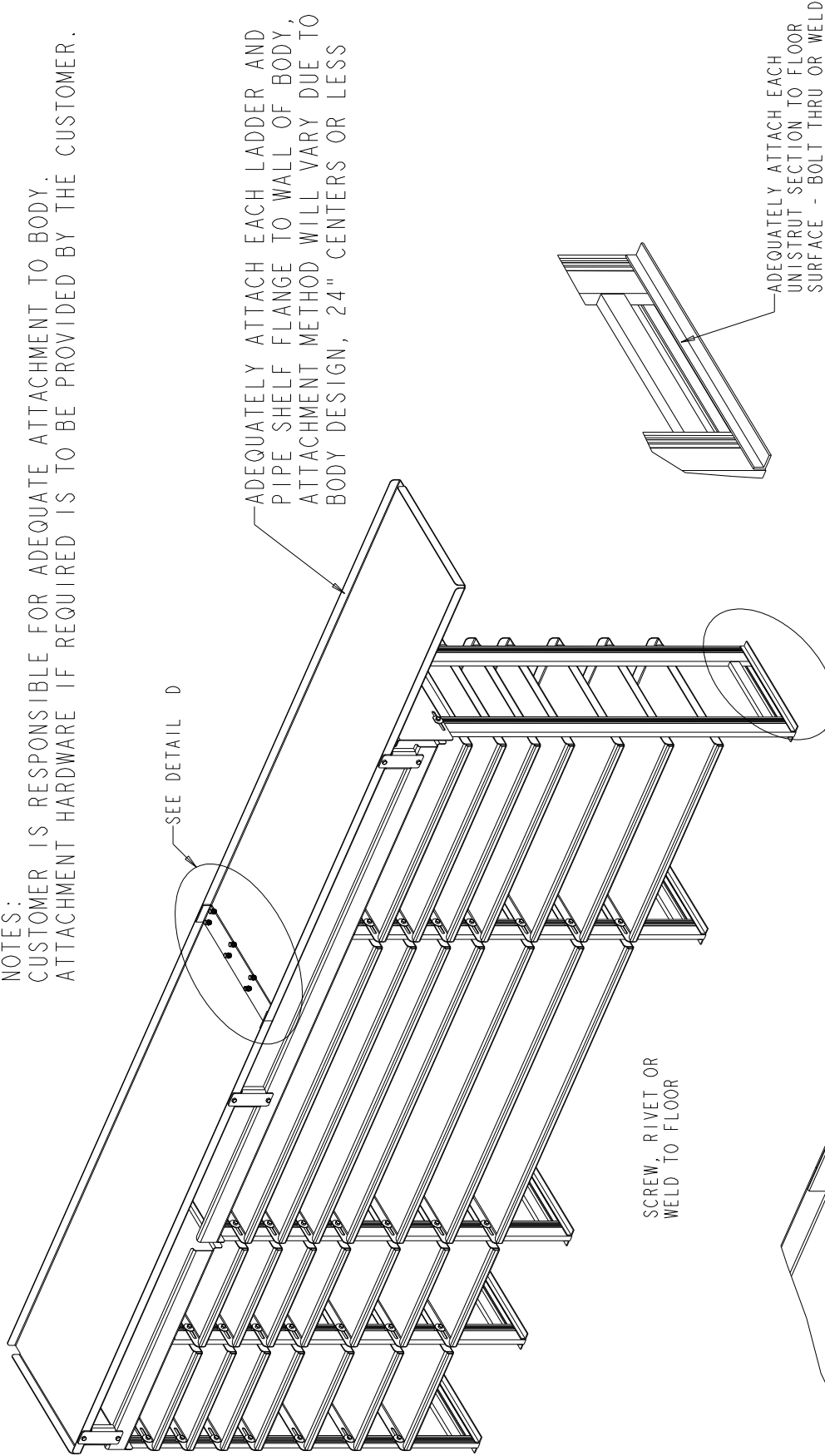

SCREW, RIVET OR  
 WELD TO FLOOR

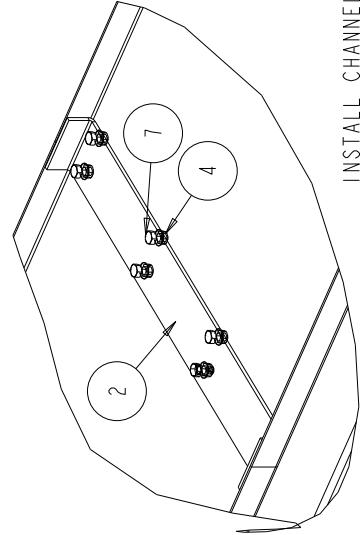

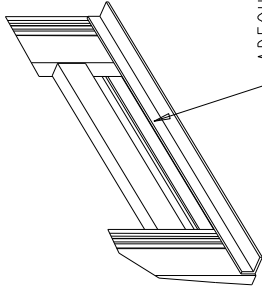

INSTALL CHANNEL ON TOP  
 OF LADDER SHELF JOINT,  
 CLAMP AND DRILL,  
 INSTALL SCREW AND NUT

DETAIL D  
 SCALE 0.250



ADEQUATELY ATTACH EACH  
 UNISTRUT SECTION TO FLOOR  
 SURFACE - BOLT THRU OR WELD

DETAIL C  
 SCALE 0.250

NUMBER	WEIGHT	TOLERANCE UNLESS OTHERWISE SPECIFIED	 <b>VT Hackney</b> A company of VT Systems 
PARTS	389.266	.XX = +/- .060 .XXX = +/- .030	
ROUTING	MATL CODE	DESCRIPTION	252-946-6521 hackney.com kibron.com vtvisioncomms.com VisionComms
FINAL	ZA	0.000	
ITEM #	SHP# DESC	DATE	
374529		15-Mgy-12	
REV/MATL	THS	APPROVED BY	
DRAWN BY	DATE	SUPERSEDED BY	
LCS	15-Mgy-12		
APPROVED BY	DATE		
SUPERSEDES		SCALE	0.100
		DRG NAME	P12C0311 Sheet 3 of 4

**SHELF ASSEMBLY LH - P2000 14' STD**

