

















**electric height adjustable  
desk**



**ASSEMBLY & USE INSTRUCTIONS**

90.014.01.0230v.A

## CAUTION / INFORMATION

- |  |   |  |   |  |
|--|---|--|---|--|
|  | Make sure no obstacles are in the desk's path.<br>Make sure the desktop is not touching any walls.<br>Make sure all cords are appropriate length to accommodate the change in height. |   |  | <b>WARNING</b><br>Pinch Point<br>Keep hands and fingers clear. |
|  | Keep children away from electric height-adjustable desks, control units and handsets. There is a risk of injury and electric shock.   |  |   |  |
|  | Keep all electrical components away from liquids.   |  |   |  |
|  | Do not sit or stand on the desk frame.<br>Do not crawl or lie under the desk frame.   |  |   |  |
|  | Do not place any objects taller than 20" underneath the desk.   |  |   |  |
|  | Do not open any of the components - the Legs, Control Box, or Switch.<br>There is a danger of electric shock.   |  |   |  |
|  | This product is designed with a duty cycle of 10%<br>(2 min. on, 18 min. off).  |  |   |  |
|  | In the event of a power outage or if the power cord is unplugged,<br>a manual reset may be necessary - see USE section.   |  |   |  |

## USE / LIABILITY

This height adjustable desk has electric motors and is designed for use in dry work areas only.

The desk height is adjustable so that it can be positioned at the most ergonomically suitable height.

Any other use is at user's risk.

Under no circumstances does the manufacturer accept warranty claims or liability claims for damages caused from improper use or handling of the desk frame.

**IMPORTANT:**  
Please read this manual carefully.  
If this desk is sold, please provide this manual to the buyer.

TOOLS

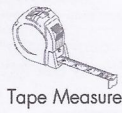
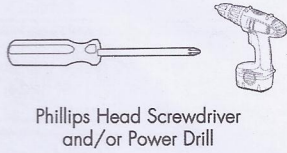
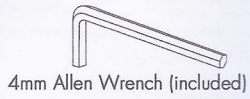

PARTS LIST

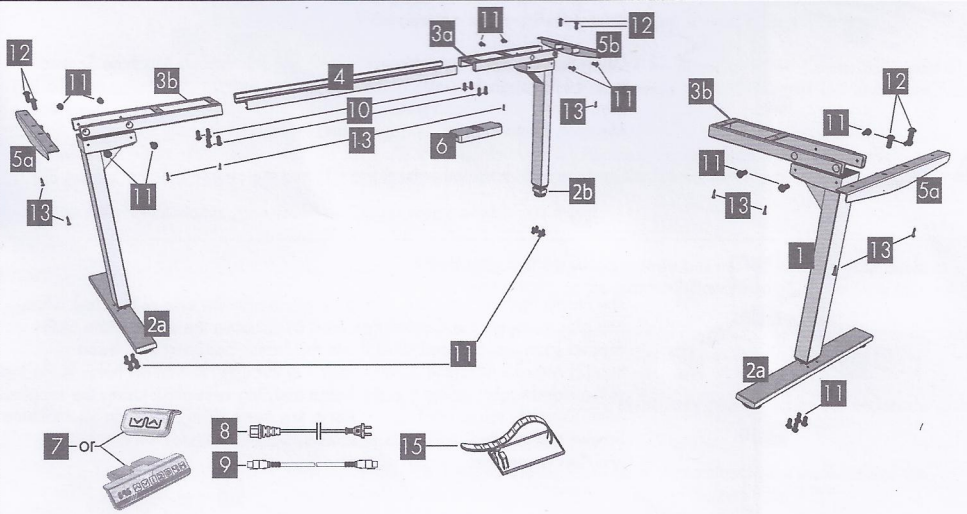

Part	Qty	Part	Qty	Part	Qty
1 Leg	3	2a Foot	2	10 M6x10 Machine Screw	8
6 Control Box	1	2b Stand-Off	1	11 M6x14 Machine Screw	24
7 Handset	1	3a Frame End	2	12 M6x35 Machine Screw	6
8 Power Cord	1	3b Frame End-CB	1	13 M5x20 Wood Screw	11
9 Cable (1.3m)	2	4 Center Rail	2	14 M5x16 Wood Screw	2
		5a Side Bracket	2	15 Cable Clip	15
		5b Side Bracket B	1		

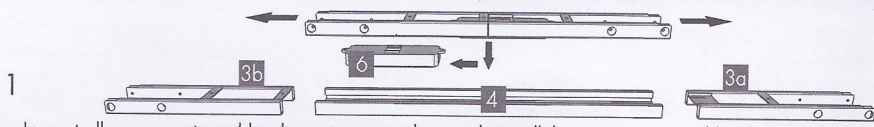

1 Lay out all components and hardware to ensure that you have all the components and hardware listed on the parts page. Slide the Control Box (part 6) off the Frame End-CB (part 3a) and set aside. Fully separate Frame End (part 3b) from Frame End-CB (part 3a). You will find the Center Rails (part 4) inside.

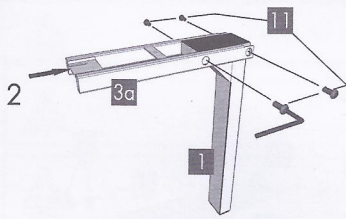

2 Place one of the Legs (part 1) into the Frame End-CB (part 3a) ensuring that the bar (arrow) is on "top" in relation to the Leg (part 1).

Line up the holes on the Leg (part 1) with the holes on the Frame End-CB (part 3a).

Using the supplied Allen Wrench, insert four (4) M6x14 Machine Screws (part 11) through the holes in the Frame End-CB (part 3a), going into the Leg (part 1) and rotate each screw just a few turns. After all four (4) M6x14 Machine Screws (part 11) are inserted, tighten all four (4) screws.

Do the same for the other Legs (part 1) and the other Frame Ends (part 3b).

**i** if you drop a screw inside the frame end, simply tilt to retrieve. **i**

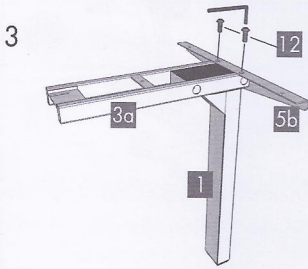

3 The Frame End-CB (part 3a) should be placed on the side of the desk where you plan to mount the Control Box (part 6). Choose the appropriate Side Bracket (part 5a, 5b) and slide it into the Frame End (part 3a). Insert two (2) M6x35 Machine Screws (part 12) through the two (2) holes in the top of the side bracket going into the frame end/leg assembly. Using the supplied Allen Wrench, rotate each screw just a few turns. After both M6x35 Machine Screws are inserted, tighten both screws. Do the same for the other frame end/leg assemblies.

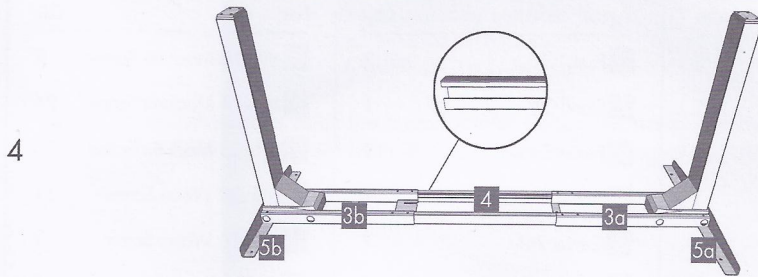

4 Slide the two (2) Center Rails (part 4) into the two Frame Ends (parts 3a & 3b) ensuring:

- a) the slots in the Center Rails (part 4) face inward
- b) the slots in the Center Rails (part 4) are closer to the top edge when the assembly is upside down (see inset).

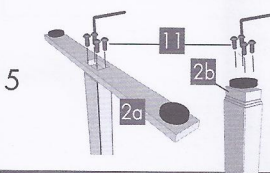

5 For two (2) assemblies that will be the outer legs of the desk base, attach a Foot (part 2a) with four (4) M6x14 Machine Screws (P11) and tighten screws in a cross pattern.

For one (1) assembly that will be the center leg of the desk base, the one with the Side Bracket-short (part 5c), attach the Stand-Off (part 2b) with four (4) M6x14 Machine Screws (part 11) and tighten screws in a cross pattern.

Your desktop may or may not be pre-drilled. Check both sides of the desktop before placing your desk base on the underside of the desktop.

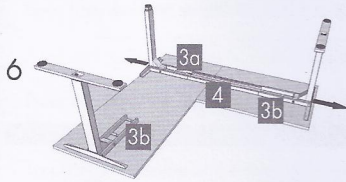

Carefully place the upside down 2-leg desk base assembly on the underside of the desktop on the longer side and/or the side with a seam in desktop (if applicable) as shown. Adjust the width of the 2-leg desk base assembly to fit the desktop by sliding the two halves outward (40" - 75"). We recommend leaving at least 1/2" of the desktop width (on each end) protruding beyond the frame width and centering the side brackets fore and aft.

Place the 1-leg desk base assembly on the shorter end of the desktop (if applicable), matching the alignment selected for the 2-leg desk base assembly.

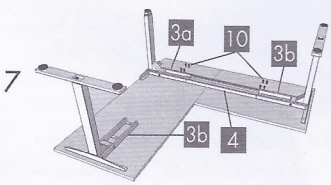

If the desktop is pre-drilled, perform Step 8 before Step 7.

If the desktop is not pre-drilled, lock the position of the Center Rails (part 4) using eight (8) M6x10 Machine Screws (part 10). Remember, maximum base width is 75".

**!** Ensure that the M6x10 Machine Screws (part 10) contacts the Center Rails (part 4) by sliding the Center Rails (part 4) as needed. **!**

**!** Double-check that the wood screws are not too long for your desktop and won't puncture the surface when screwed all the way in. **!**

**i** We recommend that you pre-drill any holes needed for fasteners if your desktop is not pre-drilled. Never use countersunk screws. **i**

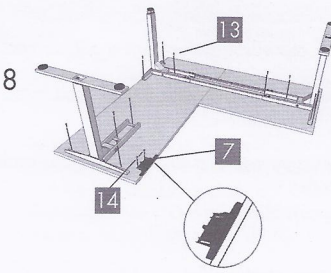

Double-check that the desk base is properly positioned on the underside of the desktop.

Attach the 1-leg and 2-leg desk base assemblies to the underside of the desktop using eleven (11) M5x20 Wood Screws (part 13).

Place the Handset (part 7) so the front of the handset is flush with the front desktop edge (or recessed up to 1/8"). The handset may be placed anywhere along the front edge of the desktop but we recommend placing it toward an end so it does not interfere with your chair when seated. Use two (2) M5x16 Wood Screws (part 14) to attach the handset to the desktop.

**!** Do not overtighten screws in this step. **!**  
Overtightening could cause damage to the components. **!**

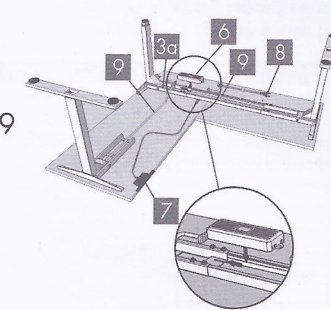

Slide the Control Box (part 6) onto the Frame End-CB (part 3a).

Connect the cable exiting the Leg (part 1) that is attached to the Frame End-CB (part 3a) directly into the Control Box (part 6).

Connect the Cables (part 9) to the other Legs (part 1) and to the Control Box (part 6).

Connect the Handset (part 7) cable to the Control Box (part 6).

Connect the Power Cord (part 8) to the Control Box (part 6).

Use the adhesive-backed Cable Clips (part 15) to secure the cables so they do not sag.

## ASSEMBLY

10 Turn the assembled desk right-side up. With at least two people, grab the DESK BASE (not the desktop) and turn the desk right-side up. Adjust the pre-installed glides on the Feet (part 2a) and Stand-Off (part 2b) as needed.

11 Plug the Power Cord (part 8) into a 110v outlet.

## USE

- ⚠ Make sure no obstacles are in the desk's path.
- ⚠ Make sure the desktop is not touching any walls.

Make sure all cords are appropriate length to accommodate the change in height.

IMPORTANT: You must RESET the desk prior to use.

RESET PROCEDURE: Press and hold the DOWN button on the Handset (part 7) until the desk reaches its lowest height. Release the DOWN button. Press and hold the DOWN button again until the LED display reads "RST". Release the DOWN button. Press and hold the DOWN button again until the desk lowers a little bit more, slightly rises and stops. Release the DOWN button. Your desk is now ready to use.

The desk base can be adjusted by pressing and holding either the UP or DOWN button until the desired height is reached.

To program up to four presets: Use the up/down buttons to find a desired height, then press "M" followed by a number 1 - 4.

CAUTION: Once a preset button is pushed, the desk will move to the programmed height (see caution box above).

## TROUBLE SHOOTING

If your desk is not functioning properly it may need to be reset. Follow the RESET procedure outlined in the USE section.

If your desk has a handset with an LED readout and it displays "RST" (reset), perform the reset procedure outlined in the USE section.

If the LED readout displays an error message ("Er1" - "Er13") confirm that all wired connections are secure (legs to cables, cables to control box). Then perform the reset procedure outlined in the USE section.

If the error message persists after the reset procedure, contact your seller.

If the height between the legs exceeds 1.5 inches, stop the reset procedure & contact your seller.

If the handset displays "HOT", let the base cool down for 20 minutes.

## SPECIFICATIONS

Height Range	23.5" - 49" (without desktop)
Base Width	39.6" min. - 74" max.
Travel Speed	1.5" per second (no load)
Load Capacity	1500N
Duty Cycle	10%. Max. 2 mins on, 18 mins off
	Soft start/stop
	Adjustable leveling studs
	4 Memory presets (some models)

## SETTING THE LED RETRACTED HEIGHT

Press the DOWN button on the Handset (part 7) until the base reaches its lowest position. Measure the height of the base from the floor and if the number on the LED display does NOT match your measurement, follow these steps:

Press and hold the DOWN button again until the LED display reads "RST". 

Press and hold the "M" button (about 5 seconds) until the LED displays the flashing starting height. (If the display returns to "RST" before the next step is taken, repeat this step.)

To change the value of the starting height:

By 0.1s:	By 1.0s:	By 10.0s:
Increase: press the UP button	Increase: press the "1" button	Increase: press the "3" button
Decrease: press the DOWN button	Decrease: press the "2" button	Decrease: press the "4" button

Once the new value is displayed, wait about 5 seconds and the display will return to "RST". Finish the reset process by pressing and holding the DOWN button again until the desk lowers a little bit more, slightly rises and stops. Release the DOWN button. The new starting height value is saved and your desk is now ready to use.

Note: the LED display has a  $\pm 0.1$  tolerance.

## SETTING THE UPPER & LOWER LIMITS

This base is designed to go to its minimum and maximum heights, allowing for the widest possible range. If you prefer to change the settings to a more narrow range, follow these steps:

Make sure the power is ON and a number reads in the LED display (if no number appears, please follow the Reset procedure described in the USE section).

To Set the Upper-Limit Position:



Use the UP/DOWN buttons to move the base to the desired maximum height position. Press and hold the "M" button until the LED display flashes "S-" once and let go of the button. Then press and release the button 2 more times in quick succession. The LED display will change to "999" on the third push, and then automatically return to the selected height. The new upper limit is now set.

To Set the Lower-Limit Position:

Use the UP/DOWN buttons to move the base to the desired minimum height position. Press and hold the "M" button until the LED display flashes "S-" once and let go of the button. Then press and release the button 2 more times in quick succession. The LED display will change to "000" on the third push, and then automatically return to the selected height. The new lower limit is now set.

To Remove the Upper/Lower Limit Positions:

Use the UP or DOWN button to move the desk to any new position. Press and hold the "M" button until the LED display flashes "S-" once and let go of the button. Then press and release the button in succession until the display changes to "555" (ignore any interim readings). After a few seconds, the display automatically will change back to the numbered height position. The upper and lower limits are now removed.

 A RESET procedure requires the desk base to full retract (beyond any lower limit set).  
Please ensure that you have the proper clearance below the desk base. 

After the upper and lower limits are set, the previous memory positions (1, 2, 3, 4) may be outside the new range of movement. If so, simply reset the memory positions.

If you attempt to revise a previously set upper or lower limit and it is outside of the existing range, you will need to remove the previously set upper/lower limits first.