



INTAKE SYSTEMS FOR VEHICLES LISTED ARE 50 STATE LEGAL. SEE KNFILTERS.COM FOR CARB STATUS ON EACH PART FOR A SPECIFIC VEHICLE.

INSTALLATION INSTRUCTIONS

57-3509
ACURA
1994-99 Integra GS-R
L4-1.8L

TOOLS NEEDED:

- 7/16" wrench or socket
- 13mm socket
- 3/4" wrench or socket
- Flat blade screwdriver
- 5mm allen wrench
- 4mm allen wrench
- 10mm socket
- ratchet

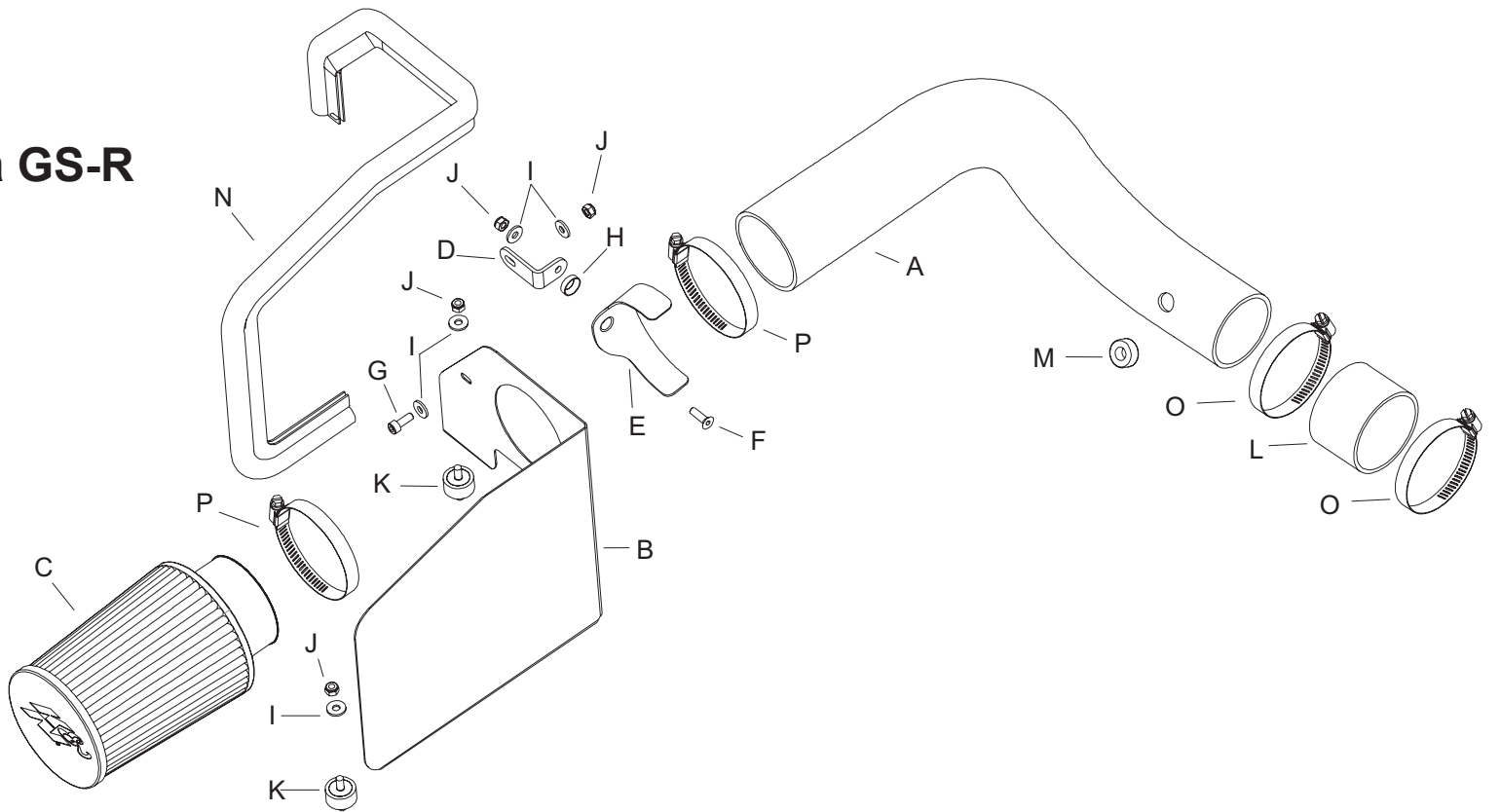

PARTS LIST:

Description	Qty.	Part #	Description	Qty.	Part #	Description	Qty.	Part #	Description	Qty.	Part #
A Intake tube	1	08753	E Saddle bracket	1	078855	I Flat washer	5	08275	M Grommet	1	08092
B Heat shield	1	07413	F Flat head allen bolt	1	08376	J Nylock nut	4	07553	N Trim seal 32"L	1	102493
C Filtercharger element	1	RF-1030	G Allen bolt	1	07818	K Rubber mounted stud	2	07027	O Hose clamp #44	2	08577
D "L" bracket	1	08022	H Conical washer	1	08180	L Silicone hose	1	08756	P Hose clamp #48	2	08601

NOTE: FAILURE TO FOLLOW INSTALLATION INSTRUCTIONS AND NOT USING THE PROVIDED HARDWARE MAY DAMAGE THE INTAKE TUBE, THROTTLE BODY AND ENGINE.

TO START:

1. Turn off the ignition and disconnect the negative battery cable.
NOTE: Disconnecting the negative battery cable erases pre-programmed electronic memories. Write down all memory settings before disconnecting the negative battery cable. Some radios will require an anti-theft code to be entered after the battery is reconnected. The anti-theft code is typically supplied with your owner's manual. In the event your vehicles' anti-theft code cannot be recovered, contact an authorized dealership to obtain your vehicles anti-theft code.

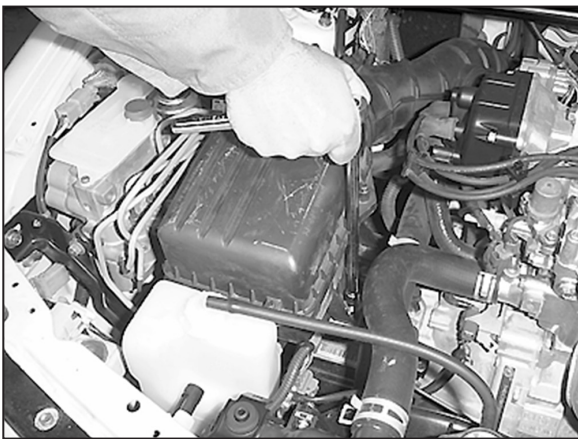

2. Loosen the 3 bolts that retain the airbox.



3. Detach the intake tube from the airbox.

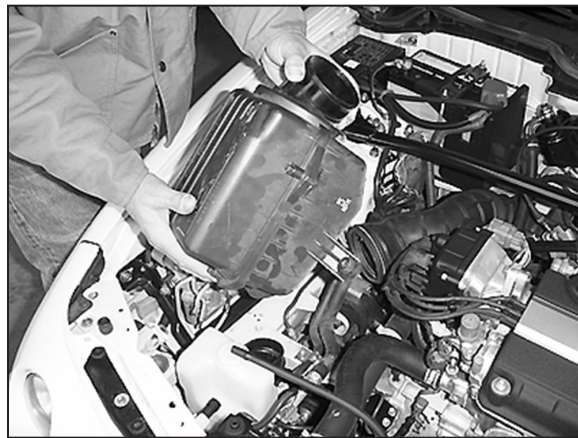

4. Remove the airbox.
NOTE: K&N Engineering, Inc., recommends that customers do not discard factory air intake.

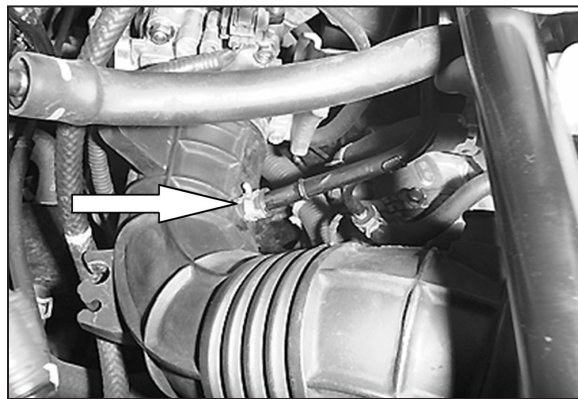

5. Remove the crankcase vent hard line from the intake tube.

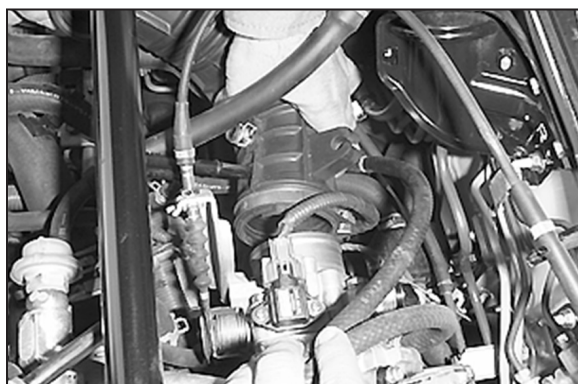

6. Loosen the hose clamp, detach the intake tube from the throttle body and remove.

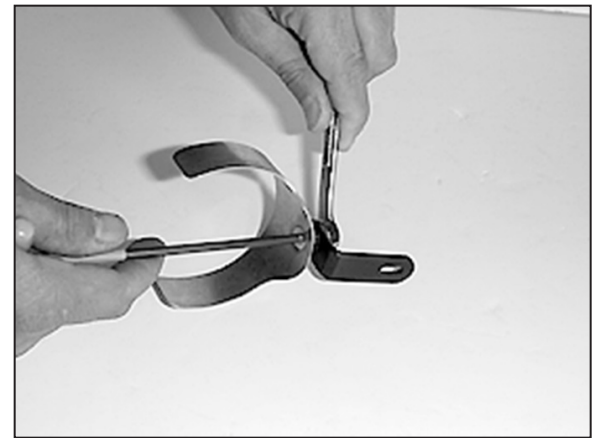

7. Assemble the saddle bracket to the "L" bracket using the hardware provided.

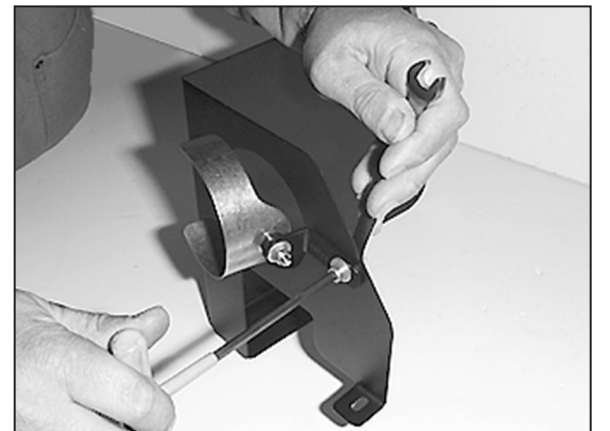

8. Attach the saddle bracket assembly to the heat shield as shown.



9. Install the trim seal onto the heat shield as shown.

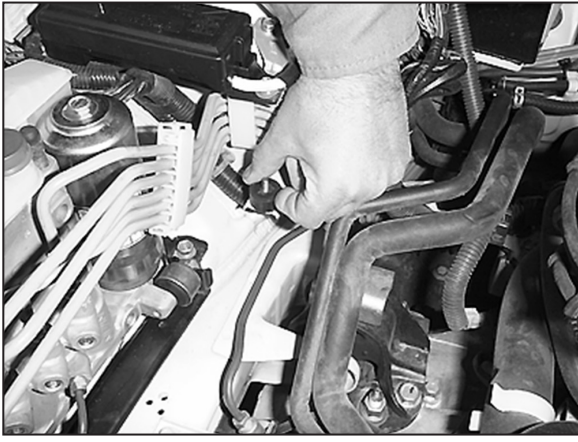

10. Install a rubber mounted stud into the upper airbox mounting point.



11. Install the second rubber mounted stud into the lower airbox mounting point.

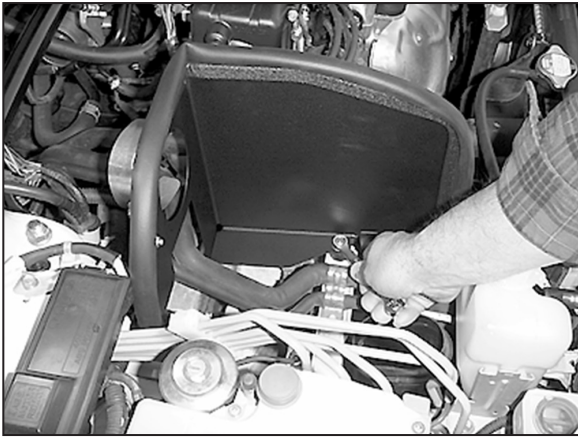

12. Install the heat shield and secure with hardware provided.



13. Insert the grommet into the small hole in the K&N intake tube.

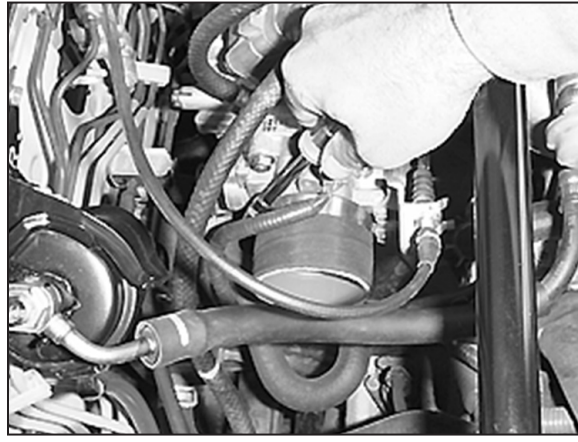

14. Attach the silicone hose to the throttle body with a hose clamp.



15. Install the K&N® intake tube through the heat shield.

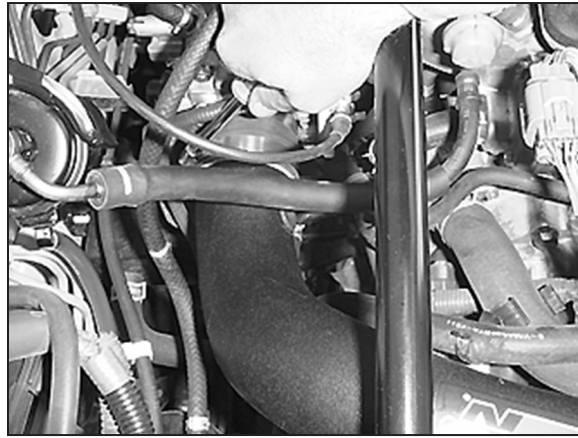

16. Insert the K&N® intake tube into the silicone hose.

NOTE: Do not tighten hose clamp completely at this time.

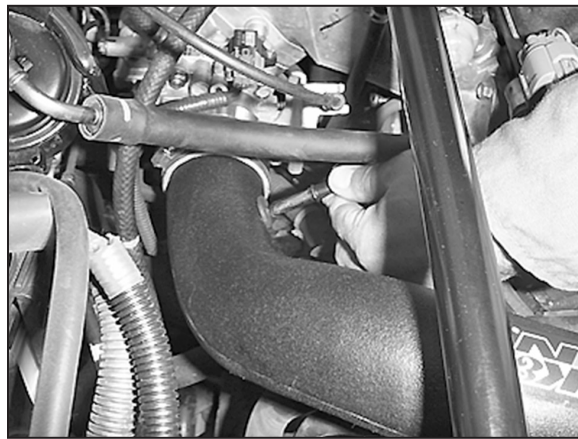

17. Insert the crankcase vent hard line into the grommet.



18. Secure the saddle bracket to the K&N® intake tube with the hose clamp provided.

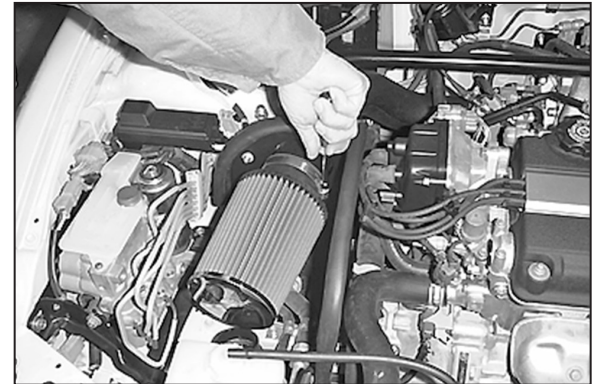

19. Install the Filtercharger element onto the K&N® intake tube and tighten hose clamp.
NOTE: Drycharger® air filter wrap; part # RC-4630DK is available to purchase separately. To learn more about Drycharger® filter wraps or look up color availability please visit <http://www.knfilters.com>®.

20. Reconnect the vehicle's negative battery cable. Double check to make sure everything is tight and properly positioned before starting the vehicle.

21. The C.A.R.B. exemption sticker, (attached), must be visible under the hood so that an emissions inspector can see it when the vehicle is required to be tested for emissions. California requires testing every two years, other states may vary.

22. It will be necessary for all K&N® high flow intake systems to be checked periodically for realignment, clearance and tightening of all connections. Failure to follow the above instructions or proper maintenance may void warranty.

ROAD TESTING:

1. Start the engine with the transmission in neutral or park, and the parking brake engaged. Listen for air leaks or odd noises. For air leaks secure hoses and connections. For odd noises, find cause and repair before proceeding. This kit will function identically to the factory system except for being louder and much more responsive.

2. Test drive the vehicle. Listen for odd noises or rattles and fix as necessary.

3. If road test is fine, you can now enjoy the added power and performance from your kit.

4. K&N Engineering, Inc., requires cleaning the intake system's air filter element every 100,000 miles. When used in dusty or off-road environments, our filters will require cleaning more often. We recommend that you visually inspect your filter once every 25,000 miles to determine if the screen is still visible. When the screen is no longer visible some place on the filter element, it is time to clean it. To clean and re-oil, purchase our filter Recharger® service kit, part number 99-5050 or 99-5000 and follow the easy instructions.

INTAKE SYSTEMS FOR VEHICLES LISTED ARE 50 STATE LEGAL. SEE KNFILTERS.COM FOR CARB STATUS ON EACH PART FOR A SPECIFIC VEHICLE.