

Square Contour Vessel Sink

Due to the hand-carving of each piece, small variances in shape and size are to be expected.

SIZE **A** DWG. NO. TD-VSL-SQR Square Contour - in

REV. **A**

WEIGHT: lbs SHEET 1 OF 1

©2017 Stone Forest, Inc.

DO NOT SCALE DRAWING

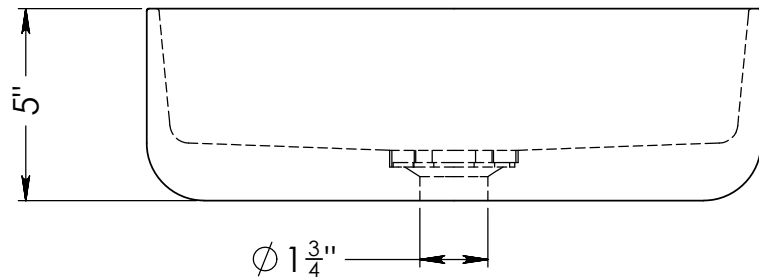
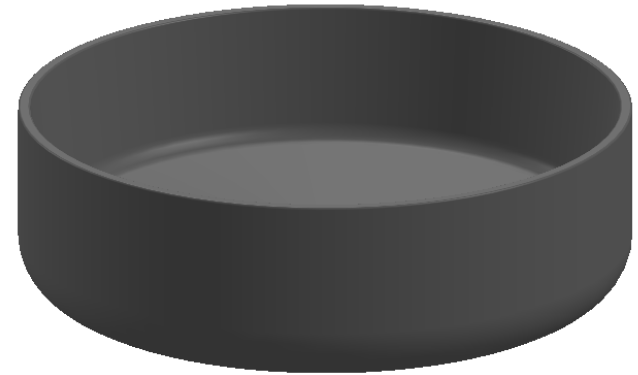
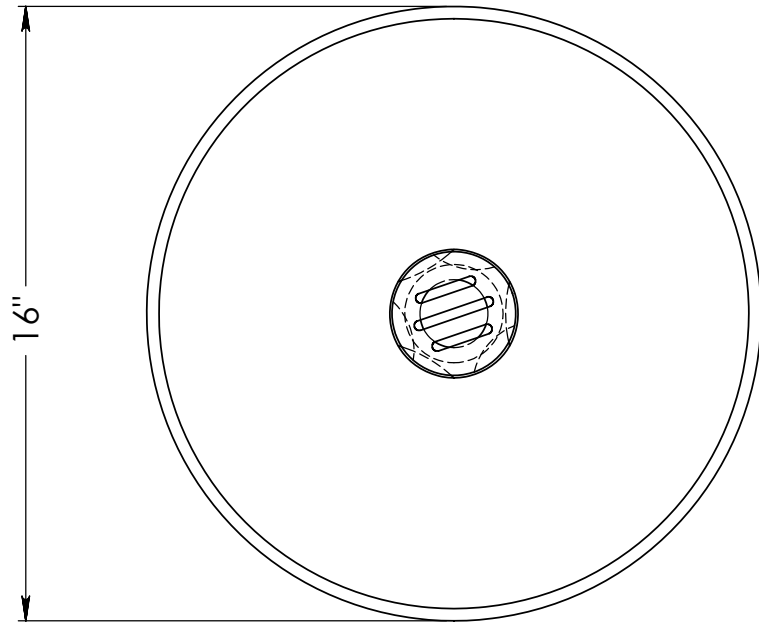

Round thin wall sink  
with drain cover opt 2 small

Due to the hand-carving of each piece, small variances in shape and size are to be expected.

SIZE **A** DWG. NO. TD-VSL-RND round thin wall sink with drain cover in

REV. **A**

MATERIAL bluestone

WEIGHT: lbs SHEET 1 OF 1

FINISH All Honed

©2017 Stone Forest, Inc.

DO NOT SCALE DRAWING

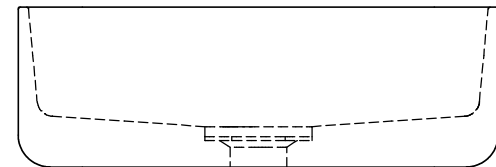
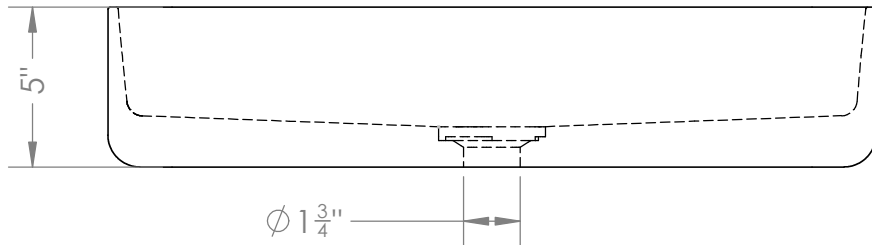
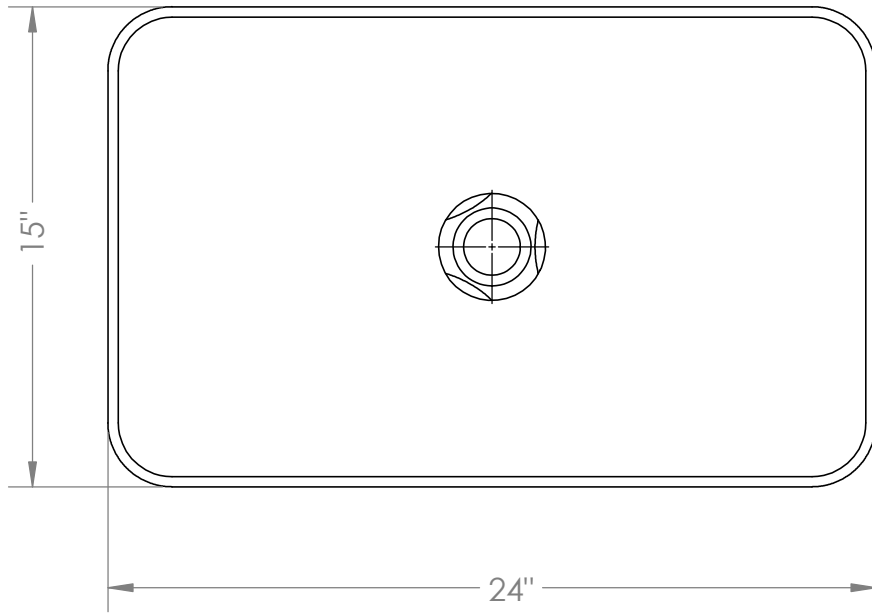

Contour Vessel Sink - Rectangle  
TD-VSL-REC

SIZE DWG. NO.  
**A** TD-VSL-REC

WEIGHT: lbs SHEET 1 OF 1

©2020 Stone Forest, Inc.

REV.  
**A**

Due to the hand-carving of each piece, small variances in shape and size are to be expected.

DO NOT SCALE DRAWING

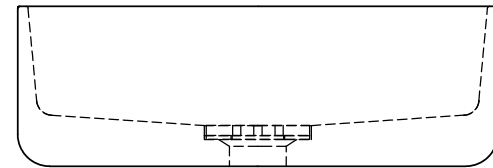
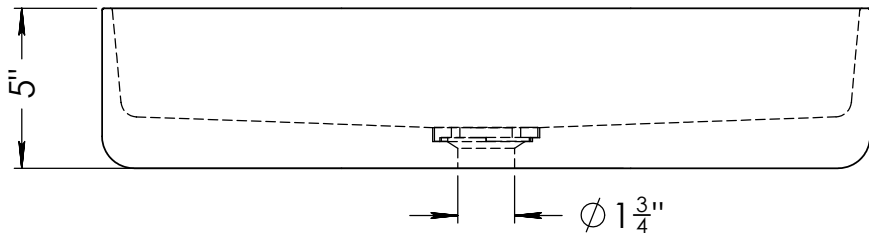
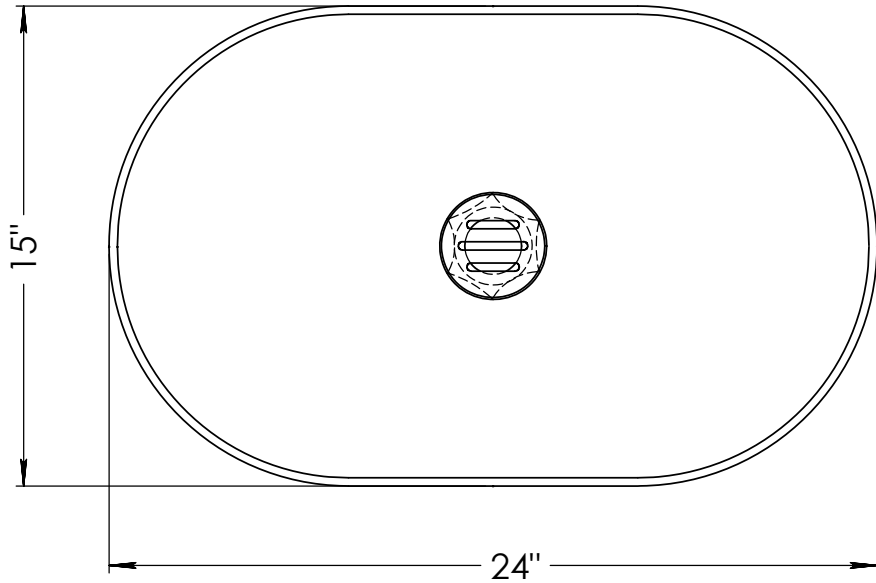

Oval Contour Vessel Sink  
TD-VSL-OVL

Due to the hand-carving of each piece, small variances in shape and size are to be expected.

SIZE <b>A</b>	DWG. NO. TD-VSL-OVL - Contour Oval Sink w Cover	REV. <b>A</b>
------------------	--	------------------

WEIGHT: SHEET 1 OF 1

©2022 Stone Forest, Inc.

DO NOT SCALE DRAWING