

SUN SYNK

THREE-PHASE HYBRID INVERTER



USER MANUAL

SUN-8K-SG04LP3 / SUN-10K-SG04LP3 / SUN-12K-SG04LP3

Global Tech China Ltd, 3 Floor, Wai Yip Industrial Building,
171 Wai Yip Street, Kwun Tong, Kowloon, Hong Kong.
Tel: +852 2884 4318 Fax: +8522884 4816
www.sunsynk.com / sales@globaltech-china.com
www.globaltechhk.com

INDEX

1. PRODUCT INTRODUCTION	3
2. TECHNICAL SPECIFICATIONS	5
3. DISPLAY	8
3.1. HOME PAGE	9
3.2. STATUS PAGE	9
3.3. SYSTEM FLOW PAGE	10
3.4. SETUP PAGE	10
3.5. SET TIME (CLOCK)	11
3.6. SET COMPANY NAME / BEEPER / AUTO DIM	11
3.7. FACTORY RESET AND LOCK CODE	12
3.8. BATTERY SETUP PAGE	12
3.9. BATTERY DISCHARGE PAGE	13
3.10. SETTING UP A LITHIUM BATTERY	13
3.11. PROGRAM CHARGE / DISCHARGE TIMES	14
3.12. GRID SUPPLY VOLTAGE AND FREQUENCY – GRID SUPPLY PAGE	14
3.13. ADVANCED SETTINGS FOR PARALLELING INVERTERS (UNDER DEVELOPMENT)	15
3.14. SOLAR POWER GENERATED	16
3.15. GRID POWER	16
3.16. ADVANCED SETTINGS FOR WIND TURBINE	17
3.17. ADVANCED SETTINGS FOR AUXILIARY LOAD	18
3.18. FAULT CODES	18

1. PRODUCT INTRODUCTION

The Sunsynk Three-Phase Hybrid Inverter is a highly efficient power management tool that allows the user to hit those 'parity' targets by managing power-flow from multiple sources such as solar, mains power (grid) and generators, and then effectively storing and releasing power as and when utilities require.

INTERACTIVE

- Easy and simple to understand LCD display;
- Supporting Wi-Fi or GSM monitoring;
- Visual power flow screen;
- Built-in 2 strings for 1 MPP tracker and 1 string for 1 MPP tracker;
- Smart settable 3-stage MPPT charging for optimised battery performance;
- Auxiliary load function;
- Parallel (coming soon) / multi-inverter function: grid-tied and off-grid;

COMPATIBLE

- Compatible with mains electrical grid voltages or power generators;
- Compatible with wind turbines;
- 230V/400V Three-phase Pure Sinewave Inverter;
- Self-consumption and feed-in to the grid;
- Auto restart while AC is recovering;
- Maximum charging/discharging current of 190A (8kW), 210A (10kW), and 240A (12kW);
- DC and AC couple to retrofit existing solar system;
- Compatible with a 48V low-voltage battery;

CONFIGURABLE

- Fully programmable controller;
- Programmable supply priority for battery or grid;
- Programmable multiple operation modes: on-grid/off-grid & UPS;
- Configurable battery charging - current/voltage based on applications by LCD setting;
- Configurable AC / solar / generator charger priority by LCD setting;
- 6 time periods for battery charging/discharging;

SECURE

- Overload/over-temperature/short-circuit protection;
- Smart battery charger design for optimised battery protection;
- Limiting function installed to prevent excess power overflow to grid;
- Isolation transformer design;

APPLICATIONS

- Marine (vessel power management);
- Power shedding (home/office/factory);
- UPS (fuel-saving systems);
- Remote locations with solar and wind generators;
- Building sites;
- Telecommunication;

The following diagram explains the basic application and architecture of this 3-Phase Inverter. The system is composed of solar panels, batteries, a generator or utility grid, normal loads, smart loads and monitoring systems.

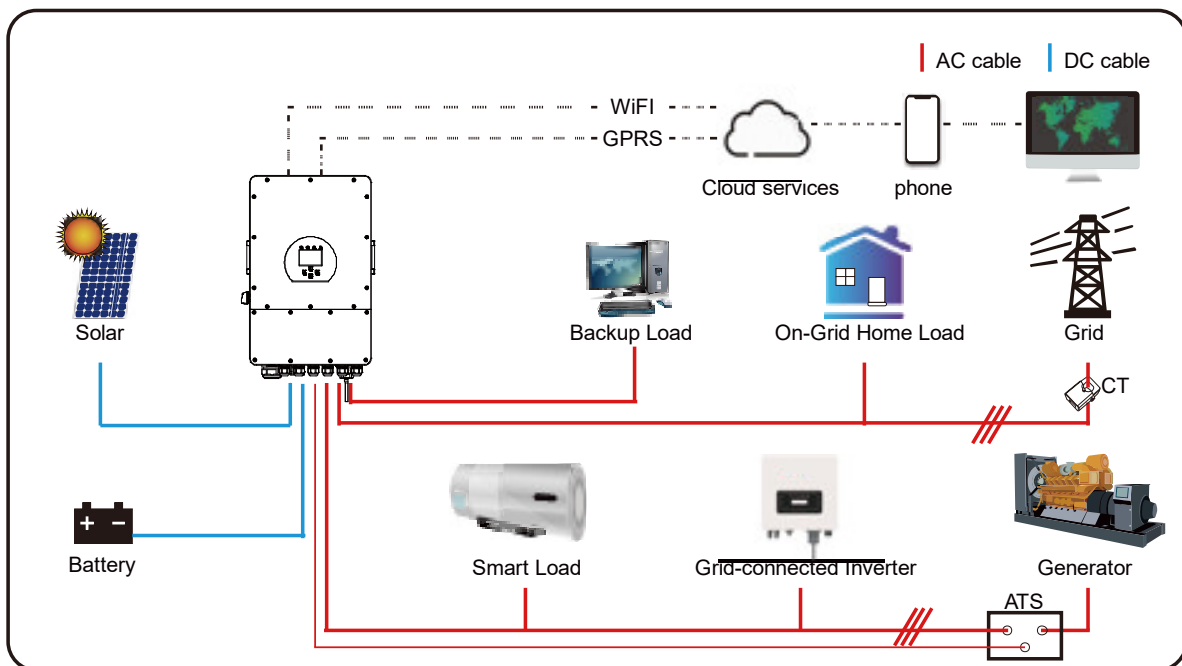

TECHNICAL SPECIFICATIONS

2. TECHNICAL SPECIFICATIONS

Model No.	SUNSYNK-8K-SG04LP3
Product Type	Hybrid Inverter
Enclosure	IP65
Ambient Temperature	-45°C ~ 60°C (>45°C derating)
Protection Level	Class I
Charge Mode	
Battery Voltage	48V (40V~60V)
Battery Current	190A (max.)
AC Input Voltage	3L/N/PE 220/380, 230/400V
AC Input Frequency	50/60Hz
AC Input Rated Current	12.1A
Max. AC Input Current	18.2A (max.)
Max. AC Input Power	8800W
Max. Apparent Output Power	8800VA
PV Input Voltage	440V (160V~800V)
MPPT Input Voltage	200 V ~ 650V
PV Input Current	13A + 13A
Max. PV Input Power	10400W
Max. PV Isc	17A + 17A
Utility-Interactive	
AC Output Voltage	3L/N/PE 220/380, 230/400V
AC Output Frequency	50/60Hz
AC Output Rated Current	12.1A
Max. AC Output Current	18.2A (max.)
Max. AC Output Power	8800W
AC Output Rated Power	8000W
AC Output Power Factor	0.8 leading to 0.8 lagging
Max. AC Isc	75A
Battery Discharge Voltage	40V~60V
Battery Discharge Current	190A (max.)
Battery Discharge Power	8000W
Stand Alone	
AC Output Voltage	3L/N/PE 220/380, 230/400V
AC Output Frequency	50/60Hz
AC Output Rated Current	12.1A
AC Output Rated Power	8000W
Max. Continuous AC	45A
Battery Discharge Voltage	40V~60V
Max. Discharge Current	190A (max.)
Compliance	C10-11, CEI 0-21, VDE-AR-N 4105, NRS 076, IEC 62116, IEC 61727, G99, G98, RD 1699, VDE 0126-1-1, IEC/EN 61000-6-1/2/3/4, IEC/EN 62109-1, IEC/EN 62109-2

TECHNICAL SPECIFICATIONS

Model No.	SUNSYNK-10K-SG04LP3
Product Type	Hybrid Inverter
Enclosure	IP65
Ambient Temperature	-45°C ~ 60°C (>45°C derating)
Protection Level	Class I
Charge Mode	
Battery Voltage	48V (40V~60V)
Battery Current	210A (max.)
AC Input Voltage	380/400V
AC Input Frequency	50/60Hz
AC Input Rated Current	15A
Max. AC Input Current	23A (max.)
Max. AC Input Power	11000W
PV Input Voltage	550V (150V~800V)
MPPT Input Voltage	200 V ~ 625V
PV Input Current	26A + 13A
Max. PV Input Power	13000W
Max. PV Isc	30A + 15A
On-Grid Mode	
AC Output Voltage	380/400V
AC Output Frequency	50/60Hz
AC Output Rated Current	15A
Max. AC Output Current	23A (max.)
Max. AC Output Power	11000W
AC Output Rated Power	10000W
AC Output Power Factor	0.8 leading to 0.8 lagging
Max. AC Isc	75A
Battery Discharge Voltage	40V~60V
Battery Discharge Current	210A (max.)
Battery Discharge Power	10000W
Off-Grid Mode	
AC Output Voltage	380/400V
AC Output Frequency	50/60Hz
AC Output Rated Current	15A
AC Output Rated Power	10000W
Max. Continuous AC	48A
Peak Output Power	20000W (10 seconds)
Battery Discharge Voltage	40V~60V
Max. Discharge Current	210A (max.)
Compliance	IEC61727, IEC62116, IEC600068, IEC61683, IEC/EN62109-1/2

TECHNICAL SPECIFICATIONS

Model No.	SUNSYNK-12K-SG04LP3
Product Type	Hybrid Inverter
Enclosure	IP65
Ambient Temperature	-45°C ~ 60°C (>45°C derating)
Protection Level	Class I
Charge Mode	
Battery Voltage	48V (40V~60V)
Battery Current	240A (max.)
AC Input Voltage	380/400V
AC Input Frequency	50/60Hz
AC Input Rated Current	18A
Max. AC Input Current	27 (max.)
Max. AC Input Power	13200W
PV Input Voltage	550V (150V~800V)
MPPT Input Voltage	200 V ~ 625V
PV Input Current	26A + 13A
Max. PV Input Power	15600W
Max. PV Isc	34A + 17A
On-Grid Mode	
AC Output Voltage	380/400V
AC Output Frequency	50/60Hz
AC Output Rated Current	18A
Max. AC Output Current	27A (max.)
Max. AC Output Power	13200W
AC Output Rated Power	12000W
AC Output Power Factor	0.8 leading to 0.8 lagging
Max. AC Isc	75A
Battery Discharge Voltage	40V~60V
Battery Discharge Current	240A (max.)
Battery Discharge Power	12000W
Off-Grid Mode	
AC Output Voltage	380/400V
AC Output Frequency	50/60Hz
AC Output Rated Current	18A
AC Output Rated Power	12000W
Max. Continuous AC	48A
Peak Output Power	24000W (10 seconds)
Battery Discharge Voltage	40V~60V
Max. Discharge Current	240A (max.)
Compliance	IEC61727, IEC62116, IEC600068, IEC61683, IEC/EN62109-1/2

3. DISPLAY



LED indicator		Meaning
DC	Green LED solid light	PV connection normal
AC	Green LED solid light	Grid connection normal
Normal	Green LED solid light	Inverter functioning normally
Alarm	Red LED solid light	Fault

Function Key	Description
Esc	To exit the previous mode
Up	Increase the value of a setting
Down	Decrease the value of a setting
Enter	Confirm setting change (If not pressed each time the setting will not be saved)

3.1. Home Page

Press the Esc button in any page to access the Home Page:

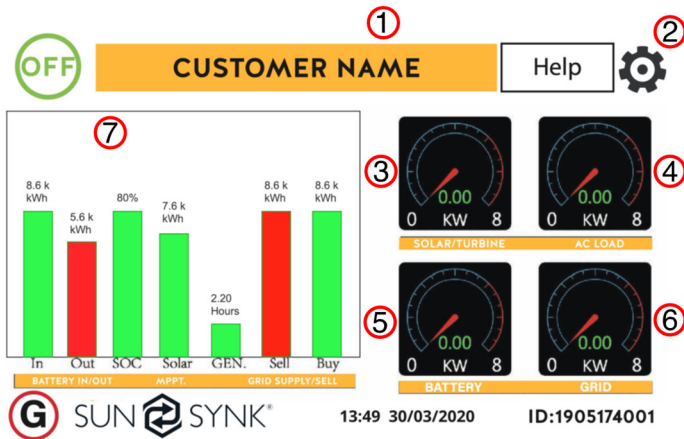

1. Customer name
2. Access settings menu page
3. Access solar history
4. Access system status page
5. Access system status page
6. Access grid history
7. Access system flow page

What this page displays:

- Total daily power into the battery (kWh).
- Total daily power out of the battery (kWh).
- SOC (State of charge of the battery) (%).
- Total daily solar power produced in (kWh).
- Total hourly usage of the generator (Time).
- Total daily power sold to the grid (kWh).
- Total daily power bought from the grid (kWh).
- Real-time solar power in (kW).
- Real-time load power in (kW).
- Real-time battery charge power in (kW).
- Real-time grid power in (kW).
- Serial number.
- Time date.
- Fault condition.
- Access stats pages.
- Access status page.
- Access fault diagnostic page.

3.2. Status Page

To access the Status page, click on the BATTERY or AC LOAD dial on the Home page.

What this page displays:

- Total solar power produced.
- MPPT 1 power/voltage/current.
- MPPT 2 power/voltage/current.
- Grid power.
- Grid frequency.
- Grid voltage.
- Grid current.
- Inverter power.
- Inverter frequency.
- Inverter voltage.

	0 W	0 W 0.0HZ	333W 50.0HZ
	220V 110W 220V 112W 221V 104W	33V 0.0A 31V 0.0A 29V 0.2A HM: LD: 0W 0W 0W 0W 0W 0W	219V 0.9A 220V 0.9A 220V 0.9A INV_P: DC_T: 110W 38.0C 112W AC_T: 111W 44.4C
	Load		
	SOC: 67% 382W	Grid Power	Inverter Power
	BAT_V:51.72 V BAT_I: 7.40 A BAT_T:-100.0C	DC_P21: 0W DC_V1: 0V DC_I1: 0.0A	DC_P2: 0W DC_V2: 0V DC_I2: 0.0A
	Battery	Solar Power 1	Solar Power 2

- Inverter current.
- Load power.
- Load voltage.
- Battery power charge/discharge.
- Battery SOC.
- Battery voltage.
- Battery current.
- Battery temperature.

3.3. System Flow Page

Access by clicking on the bar chart on the Home Page.

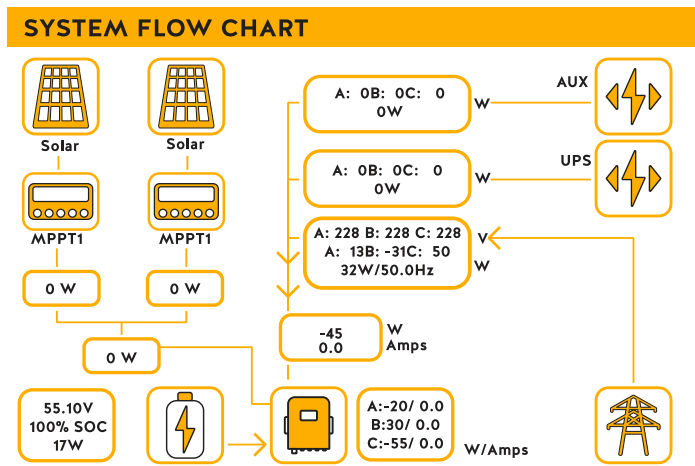

What this page displays:

- The system flow.
- MPPTs power.
- Battery status.
- Power distribution to load or grid.

3.4. Setup Page

To access the Settings, click on the gear icon  on the right top of the navigation menu.

The 'SETTINGS' page header includes the 'SUN SYNK' logo, the time '13:49', and the date '30/03/2020'. Below the header is a grid of settings categories, each with an icon:

- BASIC (gear icon)
- BATTERY (battery icon)
- GRID (grid icon)
- SYSTEM MODE (monitor icon)
- ADVANCE (gears icon)
- AUX LOAD (lightning bolt icon)
- FAULT CODES (warning triangle icon)
- LI BMS (Li battery icon)

 At the bottom of the page, a status bar displays: ID: 1906264059, SD, - COMM:e295, and -MCU: Ver1400.

What this page displays:

- Serial number.
- Software version.
- Time, Date, and MCU.

What you can do from this page:

- Access the Basic Setup Page (press the BASIC icon).
- Access the Battery Setup Page (press the BATTERY icon).
- Access the Grid Setup Page (press the GRID icon).
- Access the real-time programmable timer/system mode (press the SYSTEM MODE icon).
- Access the advanced settings such as Wind Turbine (press the ADVANCE icon).
- Access the auxiliary load/smart load settings (press the AUX LOAD icon)
- Access the fault code register (press the FAULT CODES icon).
- Set up Li BMS (press the LI BMS icon).

3.5. Set Time (Clock)

To set time, click on the BASIC icon and then on 'Time'.

Basic Setup		Help	
Time	Display	Reset	
<input type="checkbox"/> Sync	Year	Month	Day
	2018	10	24
<input type="checkbox"/> AM/PM	Hour	Minute	Second
	01	53	17
Cancel		OK	

What this page displays:

- Time.
- Date.
- AM/PM.

What you can do from this page:

- Adjust / set time.
- Adjust / set date.
- Adjust / set AM/PM.

3.6. Set Company Name / Beeper / Auto dim

To set company name click on the BASIC icon and then on 'Display'.

Basic Setup		Help	
Time	Display	Reset	
Set Company name			
M	Y	C	O
M	P	A	N
Y			
ABCDEFGHIJKLMN OPQRSTUVWXYZ1234567890.-			
Beeper On / Off <input type="checkbox"/>		Auto Dim Sec <input type="checkbox"/>	
Cancel		OK	

What this page displays:

- Beeper status (ON/OFF).
- Installers names.

What you can do from this page:

- Set up your company name.
- Switch the beeper ON or OFF.
- Set the LCD backlight to auto dim.

3.7. Factory Reset and Lock Code

To set time, click on the BASIC icon and then on 'Reset'.

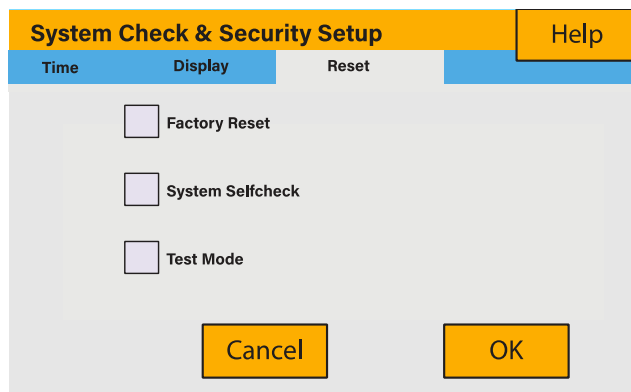

What this page displays:

- Reset status.
- Whether the 'lock code' is used or not.

What you can do from this page:

- Reset the inverter to the factory settings.
- System diagnostics.
- Change or set the 'lock code'.

3.8. Battery Setup Page

To configure battery settings, click on the BATTERY icon and then on 'Batt type'.

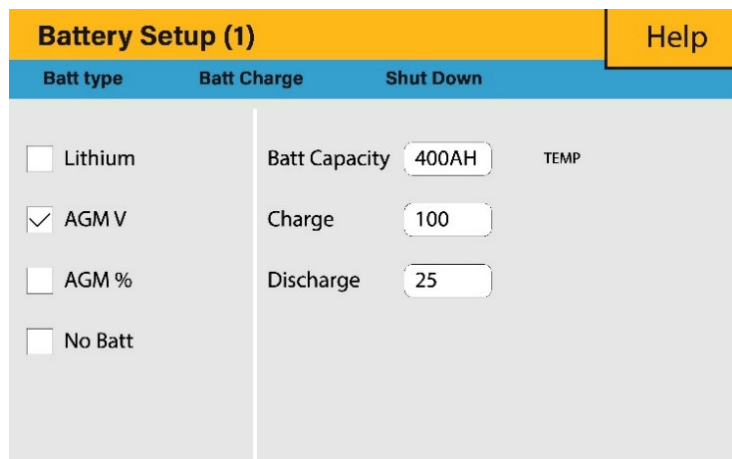

What this page displays:

- Battery capacity in (Ah) – For non-BMS-batteries the range allowed is 0-2000Ah, while for lithium-ion the inverter will use the capacity value of the BMS.
- Max battery charge current (Amps).
- Max battery discharge current (Amps), which should be 20% of the Ah rating for AGM only. For Lithium, please refer to the battery manufacturer documentation. **Note:** This is a global max. discharge current for both 'grid-tied' and 'backup' modes of operation and if the current exceeds this value inverter will shut down with an overload fault.
- TEMPCO settings - Temperature coefficient is the error introduced by a change in temperature.

What you can do from this page:

- Use battery voltage for all settings (V).

- Use battery SOC for all settings (%).
- No battery: tick this box if no battery is connected to the system.
- BMS setting.
- Active battery - This feature will help recover a battery that is 100% discharged by slowly charging from the solar array. Until the battery reaches a point where it can charge normally.

3.9. Battery Discharge Page

To configure inverter's shutdown settings, click on the BATTERY icon and then on 'Shut Down'.

What this page displays:

- Inverter shutdown voltage set as either a voltage or %.
- Inverter low battery warning set as either a voltage or %.
- Restart voltage set as either a voltage or %.

What you can do from this page:

- Adjust battery shut down (voltage or %)
- Adjust low battery warning (voltage or %)
- Adjust restart (voltage or %)

3.10. Setting Up a Lithium Battery

To set up a lithium-ion battery, click on the BATTERY icon and visit the 'Batt Type' column.

What this page displays:

- This information will only display if the 'Lithium' option is selected under 'Batt Type'.
- The type of communication protocol.
- Approved batteries.

What you can do from this page:

- Set up your lithium battery.

3.11. Program Charge / Discharge Times

To set 'Charge' and 'Discharge' times, click on the 'System Mode' icon after clicking on the gear icon.

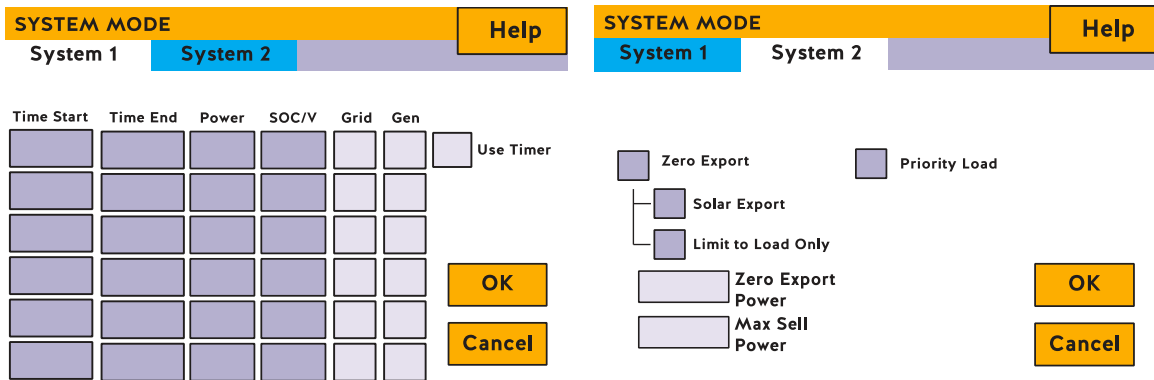

What this page displays:

- A setting to prevent the inverter exporting power to the grid - 'Zero Export'.
- The ability to limit power supply to only the household loads - 'Solar Export'.
- Set the power limits to supply only the loads connected to the LOAD port - 'Priority to Load Only'.

What you can do from this page:

- Set a real time to charge or discharge the battery.
- Choose to charge the battery from the grid or generator.
- Limit export power to the grid.
- Set the unit to **charge** the battery from the grid or generator ticking 'Grid' or 'Gen' and set what times this needs to occur.
- Set the time to **discharge** the unit to the load or export to the grid by unticking 'Grid' and 'Gen'.

3.12. Grid Supply Voltage and Frequency – Grid Supply Page

On the Settings Menu, click on the GRID icon.

What this page displays:

- Grid frequency setting
- Grid type (normally 230V three-phase)

What you can do from this page:

- Change grid's frequency setting (normally 50 Hz)
- Set the Maximum Grid Input Voltage ('Grid Vol High')

- Set the Minimum Grid Input Voltage ('Grid Vol Low')
- Set the Maximum Grid Frequency ('Grid Hz High')
- Set the Minimum Grid Frequency ('Grid Hz Low')
- ✓ Select the correct Grid Type in your local area, otherwise the machine will not work or be damaged.
- ✓ Select the correct Grid Frequency in your local area.

3.13. Advanced Settings for Paralleling Inverters (UNDER DEVELOPMENT)

3.14. Solar Power Generated

This page shows the daily, monthly, yearly, and total solar power produced. Access this page by clicking on the 'Solar/Turbine' icon on the Home Page.

Return	Day	Month	Year	Total
--------	-----	-------	------	-------

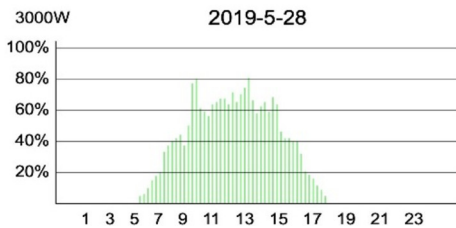

Solar Total Today=0.0KWH Total - 0.0KWH

Return	Day	Month	Year	Total
--------	-----	-------	------	-------

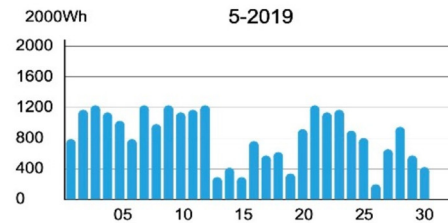

Solar Total Month=0.0KWH Total - 0.0KWH

Return	Day	Month	Year	Total
--------	-----	-------	------	-------

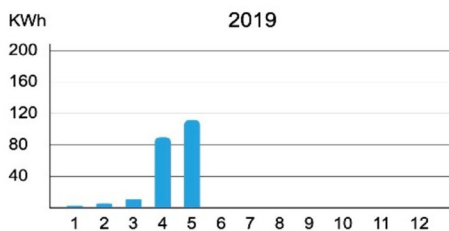

Solar Total Year=0.0KWH Total - 0.0KWH

Return	Day	Month	Year	Total
--------	-----	-------	------	-------

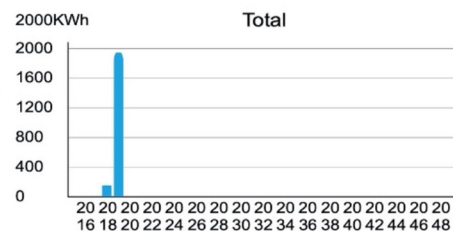

Solar / Turbine Power Total :- 135.20 kWh

3.15. Grid Power

This page shows the Daily / Monthly / Yearly and total grid power export or consumed. Access this page by clicking on the 'Solar/Turbine' icon on the home page.

Return	Day	Month	Year	Total
--------	-----	-------	------	-------

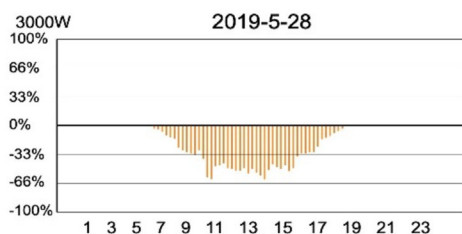

Grid Power Import / Export :- Day

Return	Day	Month	Year	Total
--------	-----	-------	------	-------

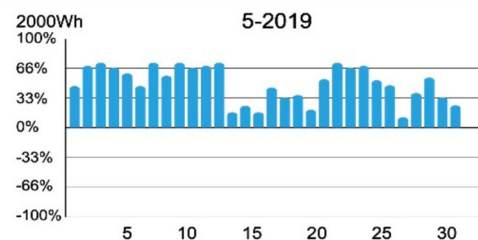

Grid Power Import / Export :- Month

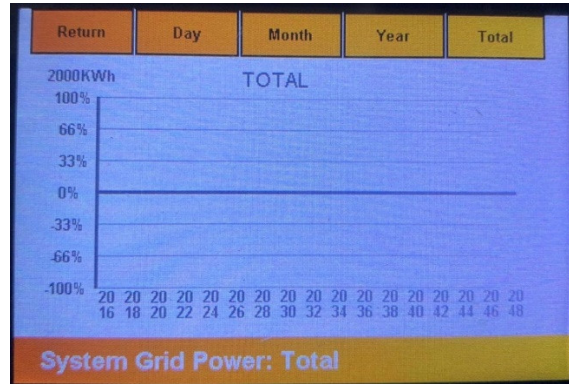
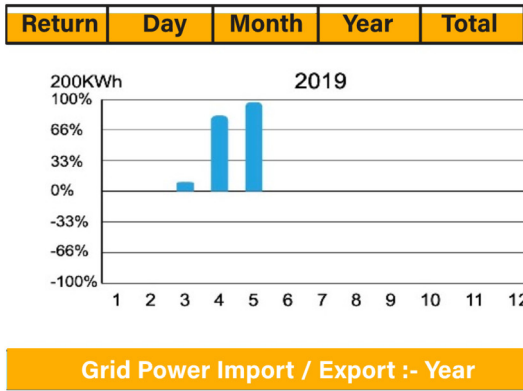

3.16. Advanced Settings for Wind Turbine

To configure wind turbine settings, click on the ADVANCE icon.

What this page displays:

- If one or both of the MPPTs are connected to a wind turbine.

What you can do from this page:

- Select the MPPT to be used as a turbine input.

Advance (2)
Help

Wind Turbine
Multi-inverter

DC1 for WindTurbine

DC2 for WindTurbine

V1	0V	0.0A	V7	0V	0.0A	<div style="background-color: #FFD700; padding: 5px; margin-bottom: 10px;">OK</div> <div style="background-color: #FFD700; padding: 5px;">Cancel</div>
V2	0V	0.0A	V8	0V	0.0A	
V3	0V	0.0A	V9	0V	0.0A	
V4	0V	0.0A	V10	0V	0.0A	
V5	0V	0.0A	V11	0V	0.0A	
V6	0V	0.0A	V12	0V	0.0A	

3.17. Advanced Settings for Auxiliary Load

To configure Auxiliary Load (previously known as “smart load”) settings, click on the AUX LOAD icon.

AUX Load Help

Gen input Gen peak shaving power 1000W

Aux load output

For Micro inverter input MI Zero Export

Aux Load OFF Batt 95%

Aux Load ON Batt 100% Solar Power(W) 1000W

Cancel OK

What this page displays:

- Use of the Gen (Aux) input or output.

What you can do from this page:

- Set up a generator input.
- Set up an auxiliary (smart) load.
- Set up Peak Power Shaving.
- Use an additional inverter or micro inverter.

3.18. Fault Codes

To check the fault codes click on the FAULT CODES icon on the settings menu.

Alarms	Occurred
F56 DC_VoltLow_Fault	2018-10-24 01:07
F56 DC_VoltLow_Fault	2018-10-24 01:07
F56 DC_VoltLow_Fault	2018-10-24 01:00
F56 DC_VoltLow_Fault	2018-10-24 00:55
F56 DC_VoltLow_Fault	2018-10-24 00:43
F56 DC_VoltLow_Fault	2018-10-24 00:10
F56 DC_VoltLow_Fault	2018-10-24 00:08
F56 DC_VoltLow_Fault	2018-10-24 00:07

Sunsynk Limited & Global Tech China Ltd,

3 Floor, Wai Yip Industrial Building.

171 Wai Yip Street, Kwun Tong,

Kowloon, Hong Kong.

Tel. HK +852 2884 4318 Fax: +852 2884 4816

Tel. UK +44 151 528 9945

Tel. SA +27 1108 39837

sales@globaltech-china.com

Audio Training manuals on Apple Pod Cast and Spotify

Full training support, manuals and videos on www.sunsynk.com



Global Tech China Ltd

3rd Floor, Wai Yip Street Kwun Tong, Kowloon, Hong Kong

Want to become a distributor? Or want to know more?

Email us: sales@globaltech-china.com Our website: www.sunsynk.com

GT website: www.globaltechchina.com

