

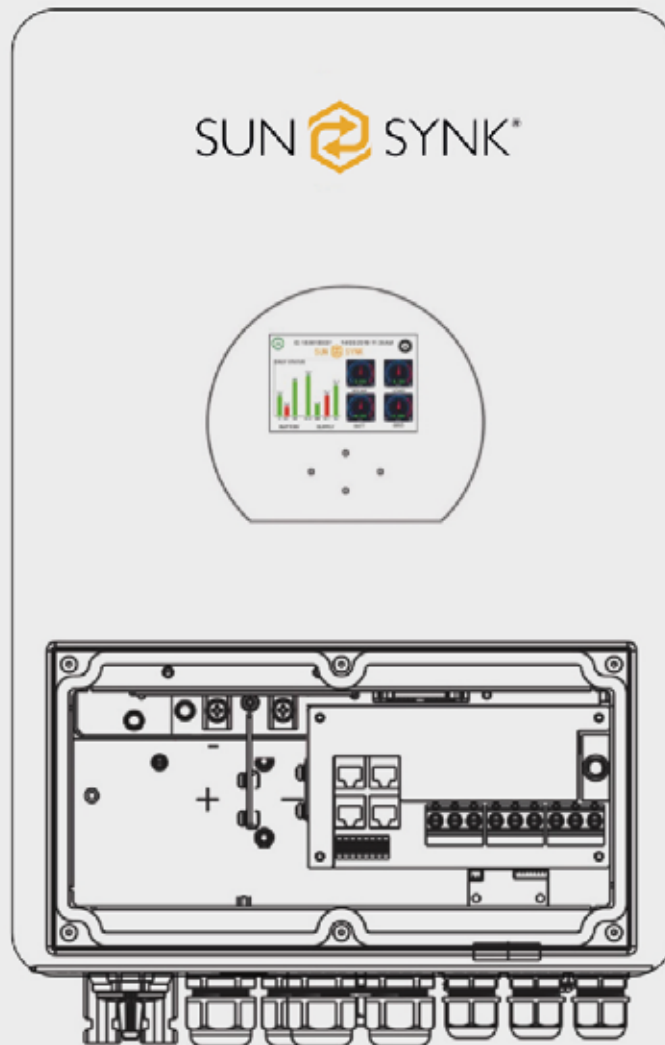

# Hybrid Parity Inverter

WITH STORAGE V 1.02



## USER MANUAL

SUNSYNK-5.5KW

Global Tech China Ltd, 3 Floor, Wai Yip Industrial Building.171 Wai Yip Street,  
Kwun Tong, Kowloon, Hong Kong.

Tel: +852 2884 4318 Fax: +8522884 4816

[www.sunsynk.com](http://www.sunsynk.com) [Sales@globaltech-china.com](mailto:Sales@globaltech-china.com) [www.globaltechhk.com](http://www.globaltechhk.com)

**Section 1 Safety**

1.01 System overview

**Section 2 Product Information**

**Section 3 Installation**

3.01 Installing the inverter

3.02 Mounting the inverter

3.03 Battery connection

3.04 AC connection

3.05 Installing the CT coil

3.06 Connecting the PV

**Section 4 Operation**

4.01 The display

4.02 Switching on/off

4.03 Home page

4.04 Status page

4.05 Set up page

4.06 Basic set up

4.07 Time set

4.08 Power shaving

4.09 Factory reset

4.10 Battery set up

4.11 Generator and battery set up

4.12 Battery discharge

4.13 Smart load

4.14 Wind turbine

4.15 Grid set up page and timers

4.16 Sell control

4.17 Grid supply page

4.18 Solar power produced data

4.19 Grid power data

**Section 5 Fault Diagnostic**

**Section 6 Examples of modes of operation**

6.01 On-grid no PV

6.02 On-grid with PV

6.03 On-grid with UPS

6.04 Off-grid with Solar

6.05 Off-grid and smart load

6.06 Off-grid with generator

**Section 7 Advanced Circuits**

A1-11 Appendix



### **WARNING !! HIGH RISK OF FIRE OR ELECTROCUTION.**

**The Sunsynk Parity Hybrid inverter can only be installed by a qualified licensed electrical contractor this is NOT a DIY product.**



- Be sure to read this manual thoroughly before installation. Do not attempt to install the inverter by yourself. Installation work must be performed in accordance with national wiring standards by authorised personnel only. Do not turn on the power until all installation work is complete.
- Always use a separate power supply line protected by a circuit breaker operating on all wires with a distance between contact of 3mm for this unit.
- The unit must be correctly grounded and the supply line must be equipped with a suitable breaker and RCD in order to protect the persons.
- The units are not explosion proof and therefore should not be installed in explosive atmosphere.
- Never touch electrical components immediately after the power supply has been turned off. Electric shock may occur. After turning off the power, always wait 5 minutes before touching electrical components.
- This unit contains no user-serviceable parts. Always consult authorised service person for repairs.

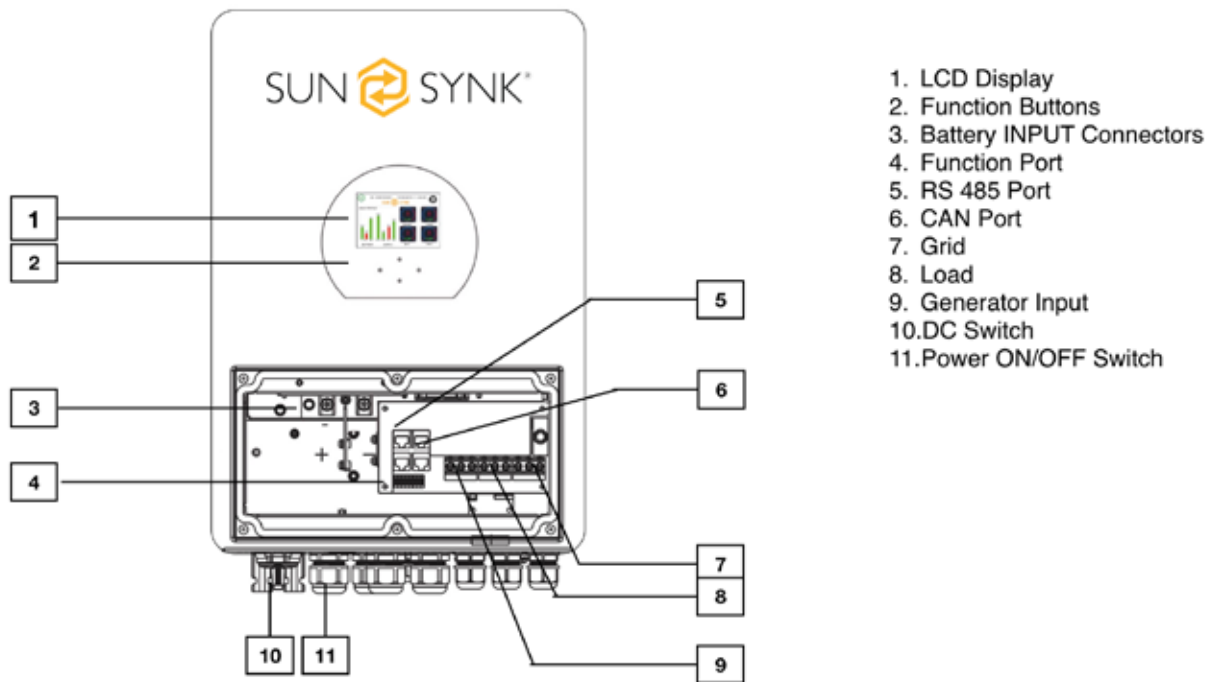

The Sunsynk Hybrid Parity Inverter is a highly efficient power management tool that allows the user to hit those 'parity' targets by managing power coming from multiple sources such as solar, mains grid and generator and then effectively storing and releasing electric power as the utilities require.

*The Inverter has many uses and is recommended for the following applications:*

- Marine (vessel power management)
- Power shedding (home / office / factory)
- UPS (fuel saving systems)
- Remote locations with solar and wind generators
- Building sites
- Military locations
- Telecommunication sites

### FEATURES

- 220V single phase, pure sine wave inverter
- Self consumption & feed-in to the grid
- Auto re-start while AC is recovering
- Programmable supply priority for battery or grid
- Programmable multiple operation modes; on-grid / off-grid & UPS
- Configurable battery charging - current / voltage based on applications by LCD setting
- Configurable AC / solar / generator charger priority by LCD setting
- Compatible with mains voltage or generator power
- Overload / over-temperature / short-circuit protection
- Smart battery charger designer optimised battery protection
- Limit-function installed to prevent excess power overflow to grid
- Supporting Wi-Fi monitoring and built-in 2 strings of MPPT trackers
- Smart settable 3-stage MPPT charging for optimised battery performance
- Time of use function
- Smart load function

## 2.00 Product Information



<b>Battery Data</b>		<b>AC Output Data</b>	
Type:	Lead-acid or Li-Ion	Rated AC Output & UPS:	5000W
Battery Voltage Range (V):	40V-60V	Peak Power Off-Grid:	10,000W (2xRated)
Max. Charging Current (A):	125 Amps	Max AC Current ( I ):	25 Amps
Max. Discharging Current (A):	125 Amps	Output Frequency:	50 / 60 Hz
AGM Charging Curve:	3-Stage / Equalisation	THD :	<3%(Linear Loading<1.5%)
External Temperature Sensor:	Optional	<b>Efficiency</b>	
Charging for Li-Ion Battery:	Self-adaption to BMS	Max. Efficiency:	97.6%
<b>PV Input Data</b>		Euro Efficiency:	97%
Max. DC Input Power (W):	6000W	MPPT Efficiency:	99.9%
Max. DC Input Voltage (V):	500V	<b>Protection</b>	
MPPT Range (V):	125-425V	PV Arc Fault Detection:	PV Input lighting protection
Start Up Voltage (V):	150V	Anti-Islanding Protection:	PV reverse polarity protection
Max. Input Current (A):	11A + 11A	Insulation Resistor:	Residual Current Monitoring Unit
Number of MPPT Trackers:	2	Output Over Current:	Output short circuit protection
Number of Strings per MPPT:	1 + 1	Output Over Voltage:	-
		Operating Temperature:	-25°C to 60°C
Weight:	20.5Kg	Noise (db):	<30 db
Size (width x height x depth):	580 x 330 x 217mm	Communication with BMS	RS485: CAN

#### Installing the Inverter

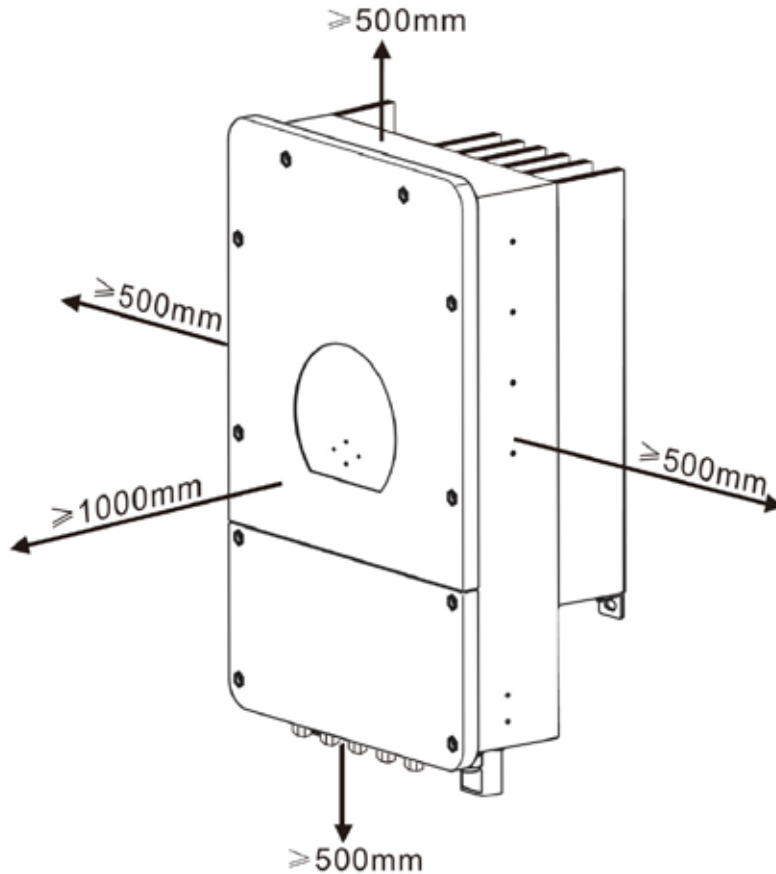

#### Do not install the unit in the following areas:

- Area with high salt content, such as marine environment. It will deteriorate metal parts, causing the parts to fail or the unit to leak water.
- Area filled with mineral oil or containing a large amount of splashed oil or steam, such as a kitchen. It will deteriorate plastic parts, causing the parts to fail or the unit to leak water.
- Area that generates substances that adversely affect the equipment, such as sulphuric gas, chlorine gas, acid, or alkali. It will cause the copper pipes and brazed joints to corrode, which can cause refrigerant leakage.
- Area that can cause combustible gas to leak, contains suspended carbon-fibre or flammable dust, or volatile inflammables such as paint thinner or gasoline.
- If gas leaks and settles around the unit, it can cause a fire.
- Any area where animals may urinate on the unit or ammonia may be generated.
- Do not install at an altitude above 2000 meters above sea level.
- Do not install in an environment of precipitation or humidity above 95%
- Do not install the unit where drainage is problematic. ALSO CONSIDER :-
- Install the indoor unit, outdoor unit, power supply cable, transmission cable, and remote control cable at least 1 m away from a television or radio receivers. The purpose of this is to prevent TV reception interference or radio noise.
- (Even if they are installed more than 1m apart, you could still receive noise under some signal conditions.)
- If children under 10 years old may approach the unit, take preventive measures so that they cannot reach the unit.
- Install the indoor unit on the wall where the height from the floors more than 1800mm.

### 3.02 Mounting the Inverter

#### Fixing the inverter to a wall

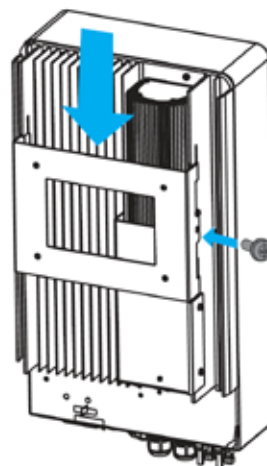
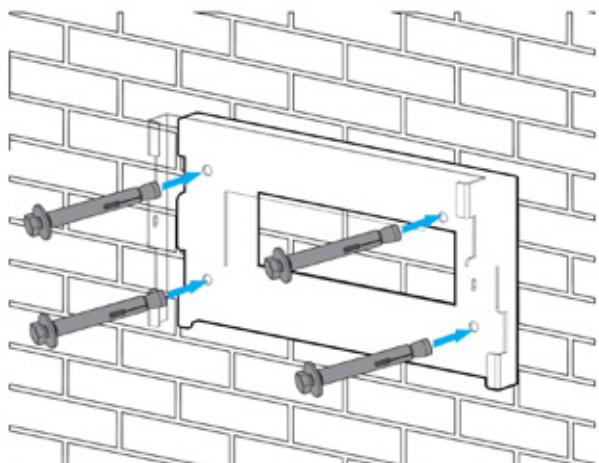

Select installation locations that can properly support the weight of the unit.

Install this inverter at eye-level in order to allow the LCD display to be read at all times.

The ambient temperature should be between  $-25\sim 60^{\circ}\text{C}$  to ensure optimal operation.

Be sure to keep other objects and surfaces as shown in the diagram to guarantee sufficient heat dissipation and have enough space for removing wires.

For proper air circulation to dissipate heat, allow a clearance of approx. 50cm to the side.

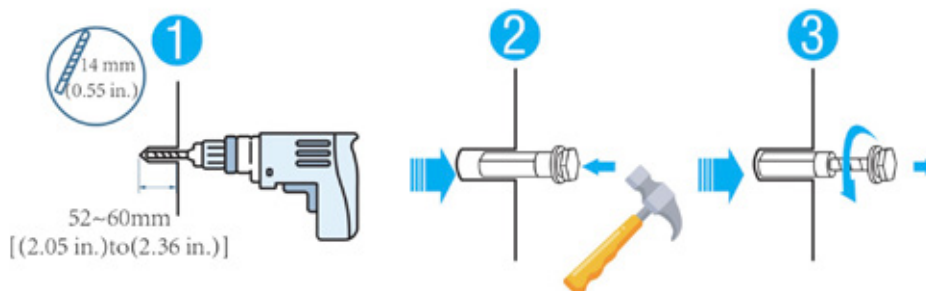

Remember that this inverter is heavy! Please be removing the inverter from the packaging and the wall

### 3.03 Battery Connection

 CAUTION

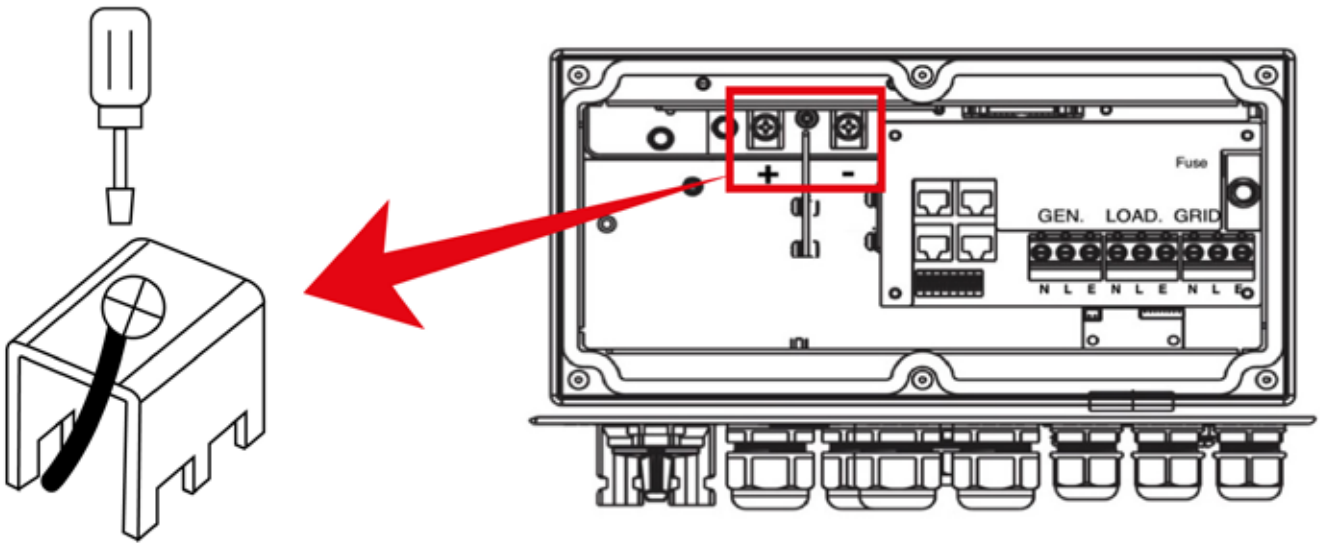

1. Please choose a suitable battery cable with correct connector, which can fit into the battery terminals.
2. Use a suitable screwdriver to unscrew the bolts and fit the battery connectors.
3. Tighten the bolts with a torque of 5.2Nm and ensure polarity is correct.

For safe operation and compliance, a separate DC over-current protector or disconnect device (see next page) is required between the battery and the inverter. In some applications, switching devices may not be required but over-current protectors are still required.

**Recommend minimum battery cable Size of 5.5kW 35mm diameter and 8.8kW 50mm diameter.**

Before making the final DC connection or closing DC breaker/disconnection; ensure the inverter is wired correctly. Reverse polarity connection on battery will damage the inverter. Positive (+) to Positive(+) and Negative (-) to Negative (-). **Reverse polarity connection on battery will damage the inverter.**

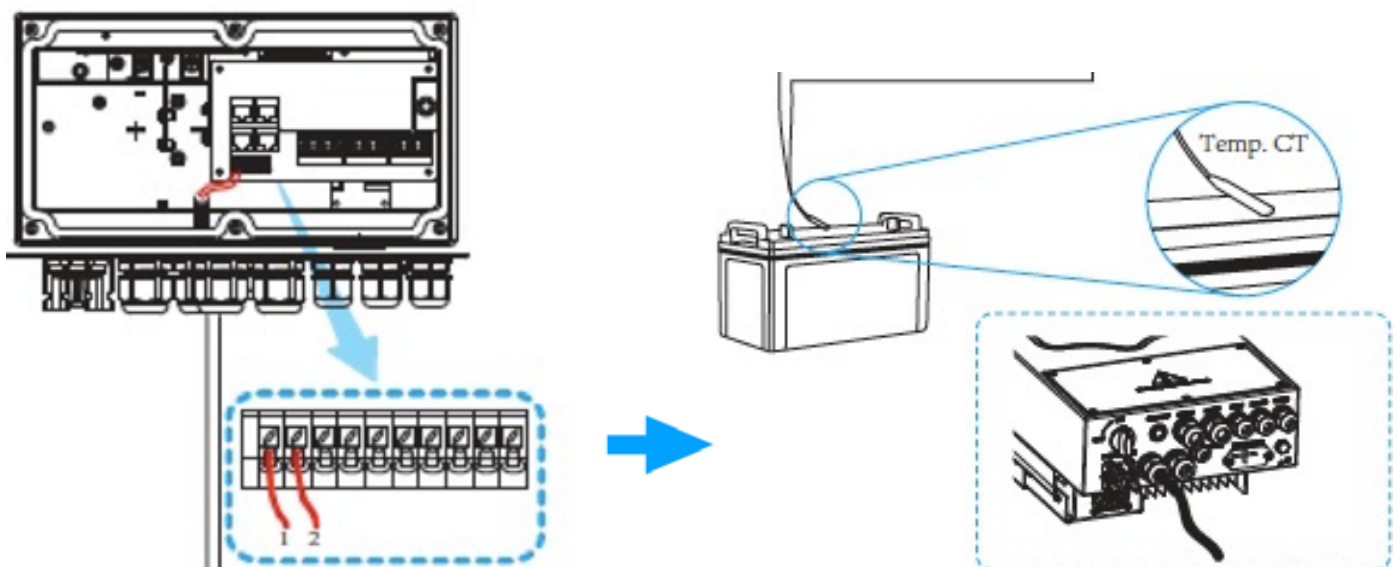



Recommend use a suitable fuse and DC Isolator

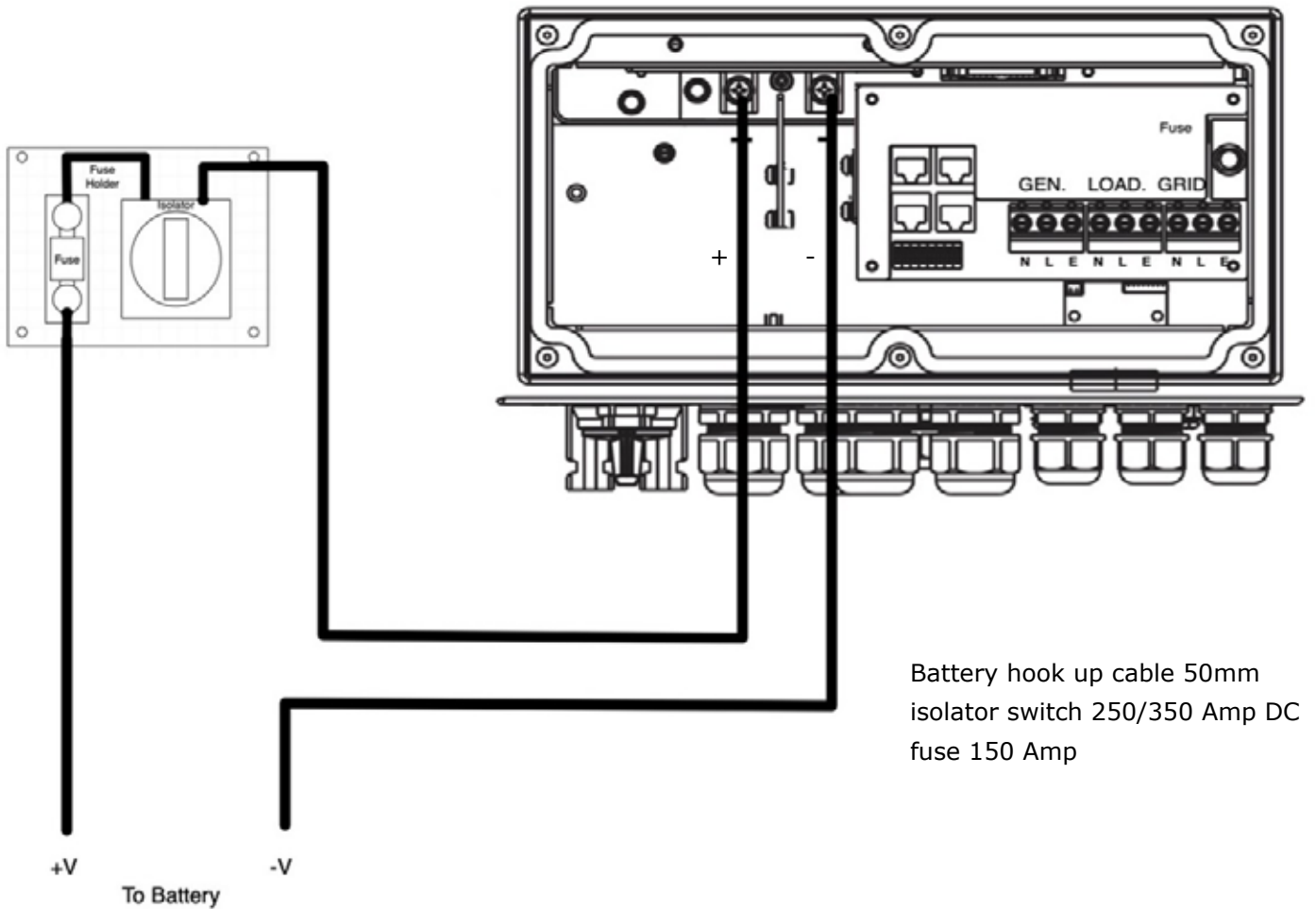
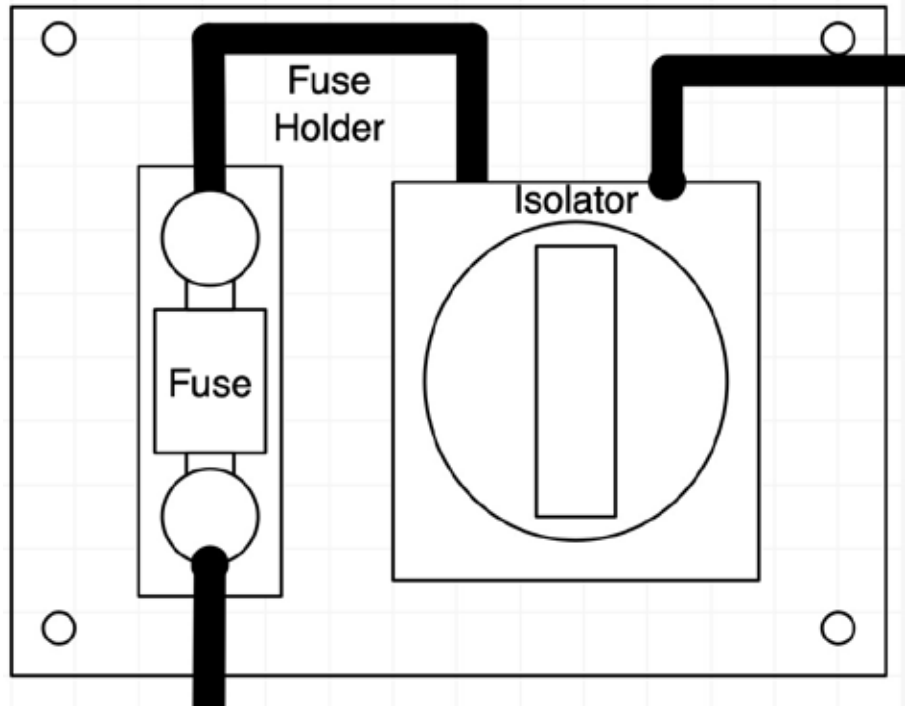
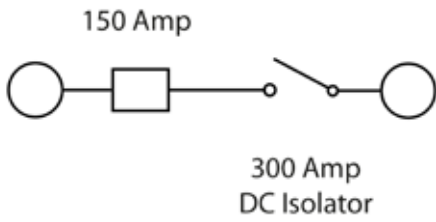

Battery hook up cable 50mm  
isolator switch 250/350 Amp DC  
fuse 150 Amp

### 3.04 AC Connection

#### AC Connection Single Inverter

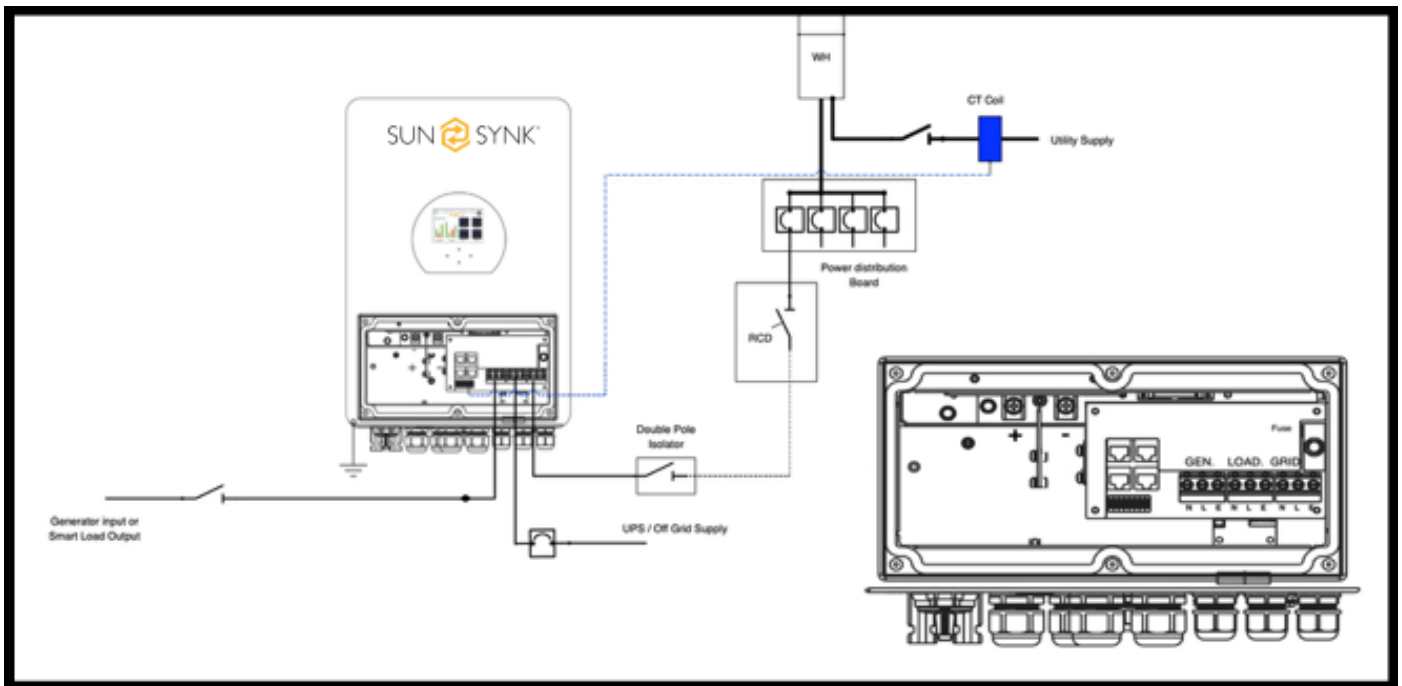

**All wiring must be in accordance with the country wiring regulations and code of practices**

Ensure suitable disconnection devices and RCDs are fitted.

**Cable sizing should be used as per the countries code of practice.**

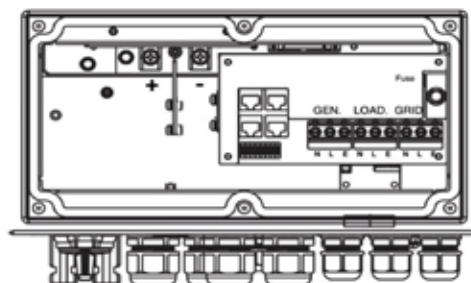
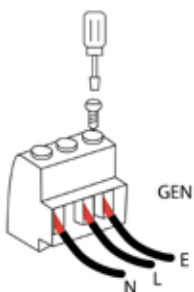

**Gen:-** This is for connection of a generator controlling a micro-inverter or smart-load.

**Load:-** This is the off-grid inverter and can be used as a UPS.

**Grid:-** This is the on-grid (parity) export limiting the grid tie inverter.

Recommend Using a Suitable AC Surge Protector Circuit

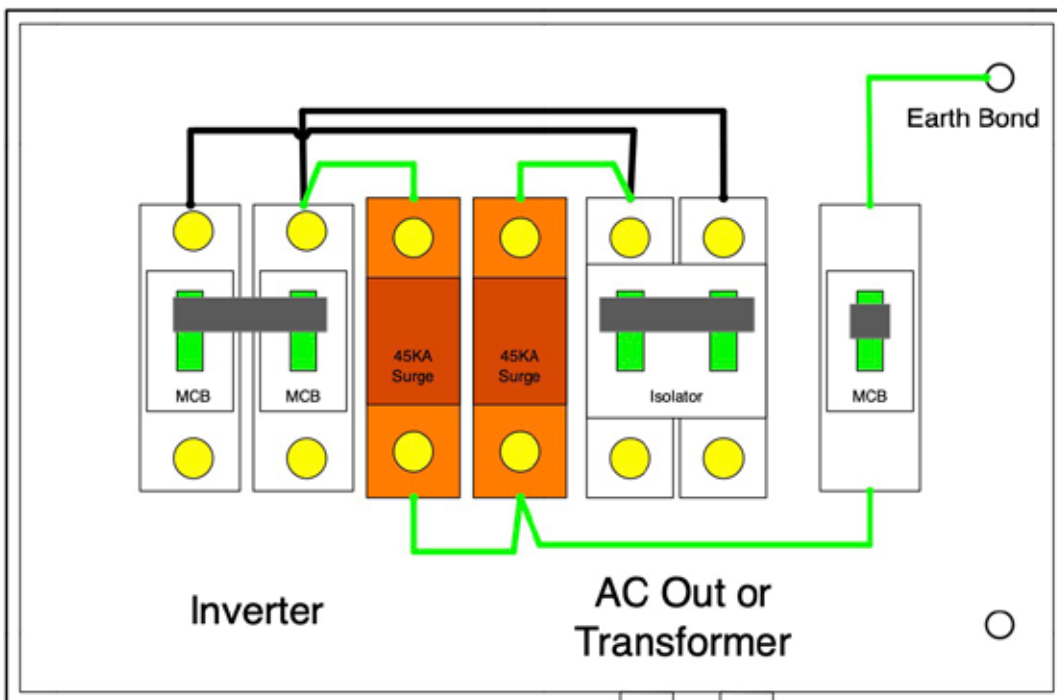
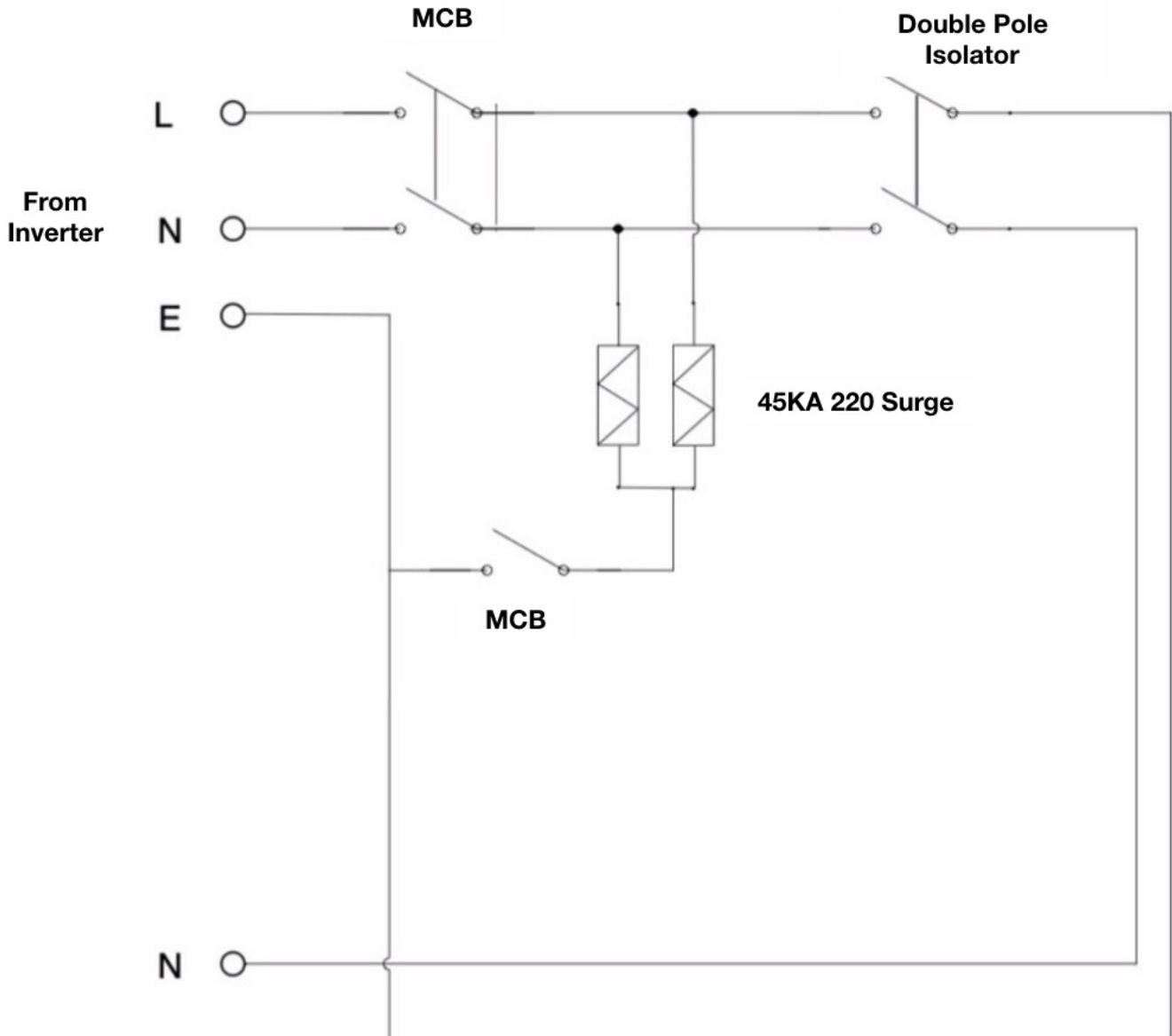

### 3.05 Installing the Coil

**CAUTION**

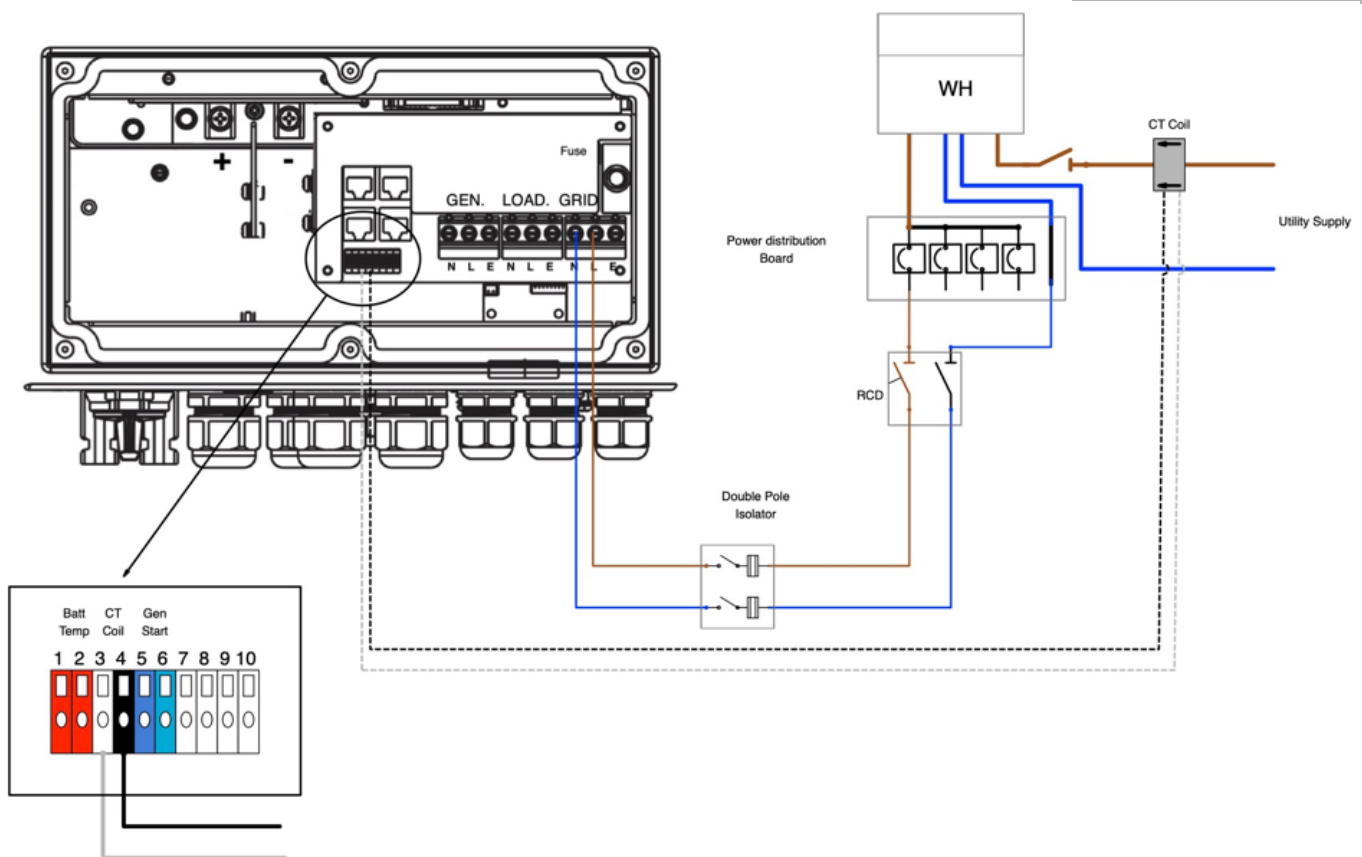

The CT coil is one of the most important parts of the Sunsynk Parity inverter, this is the device that senses any export power and reduces the power of the inverter to obtain zero export.

Fit the coil (sensor) around the live cable on the main fuse feeding the building (see below) and run the cable back to the inverter, this cable can be extended up to an extra 10 metres using similar cable.

Connect the other end of the CT coil into the inverter terminals marked **CT coil** (see the pic below to the right).

**IMPORTANT** Check the coil is fitted correctly less the battery icon to see the screen below.

If the CT coil is fitted backwards it will show on the HM power a negative value will be shown on the screen below, if this is the case turn the CT coil by 180' (re - check).

Solar	Grid	INV	Load	Batt
447W	700W	0W	0W	-402W
	50.0 Hz	50Hz		52%
L1:272V		230V	230V	50.05V
0.7A	226V	0.0A		-8.04A
216W				24.8C
L2:286V	HM:-730 W			DC:54.6C
0.8A	LD 735W			AC:33.8C
231W				

Solar	Grid	INV	Load	Batt
447W	700W	0W	0W	-402W
	50.0 Hz	50Hz		52%
L1:272V		230V	230V	50.05V
0.7A	226V	0.0A		-8.04A
216W				24.8C
L2:286V	HM: 630 W			DC:54.6C
0.8A	LD 735W			AC:33.8C
231W				

This Should not be a negative

### 3.06 Connecting the PV

Connecting PV panels

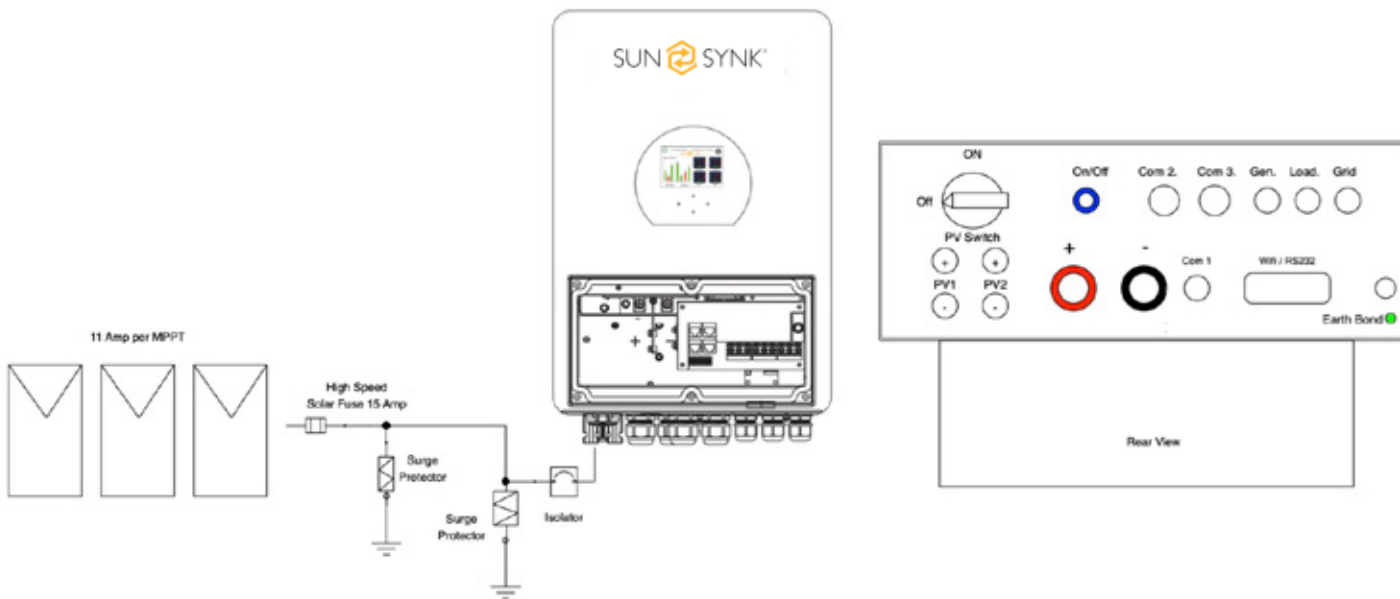

The inverter has two built-in MPPT controllers that can connect two sets of panels with a maximum current of 11 Amp per MPPT. Before connecting to the PV modules, install a separate DC circuit breaker between the inverter and PV modules. To avoid any malfunction, do not connect any PV modules with possible current leakage to the inverter. For example; grounded PV modules will cause current leakage to the inverter.

**IMPORTANT - The open circuit voltage (Voc) of PV modules should be higher than the minimum start voltage.**

## 4.01 The Display

Switching on



LED Indicator		Meaning
DC	Green LED solid light	PV connection normal
AC	Green LED solid light	Grid connection normal
Normal	Green LED solid light	Inverter functioning normally
Alarm	Red LED solid light	Fault

Function Key	Description
Esc	To exit the previous mode
Up	Increase value of a setting
Down	Decrease value of a setting
Enter	Confirm setting change ( If not pressed each time, the setting will not save )

## 4.02 Switching ON/OFF

Once the unit has been properly installed and the batteries are connected press On/Off button (located on the bottom of the case) to turn on the unit.

When the system is connected without a battery but connected with either PV or Grid and ON/OFF button is switched off, LCD will still light up (display will show OFF). In this condition, when switch on ON/OFF button and select NO battery, The system can still work.

### 4.03 Home Page

Press Esc button from any page to access

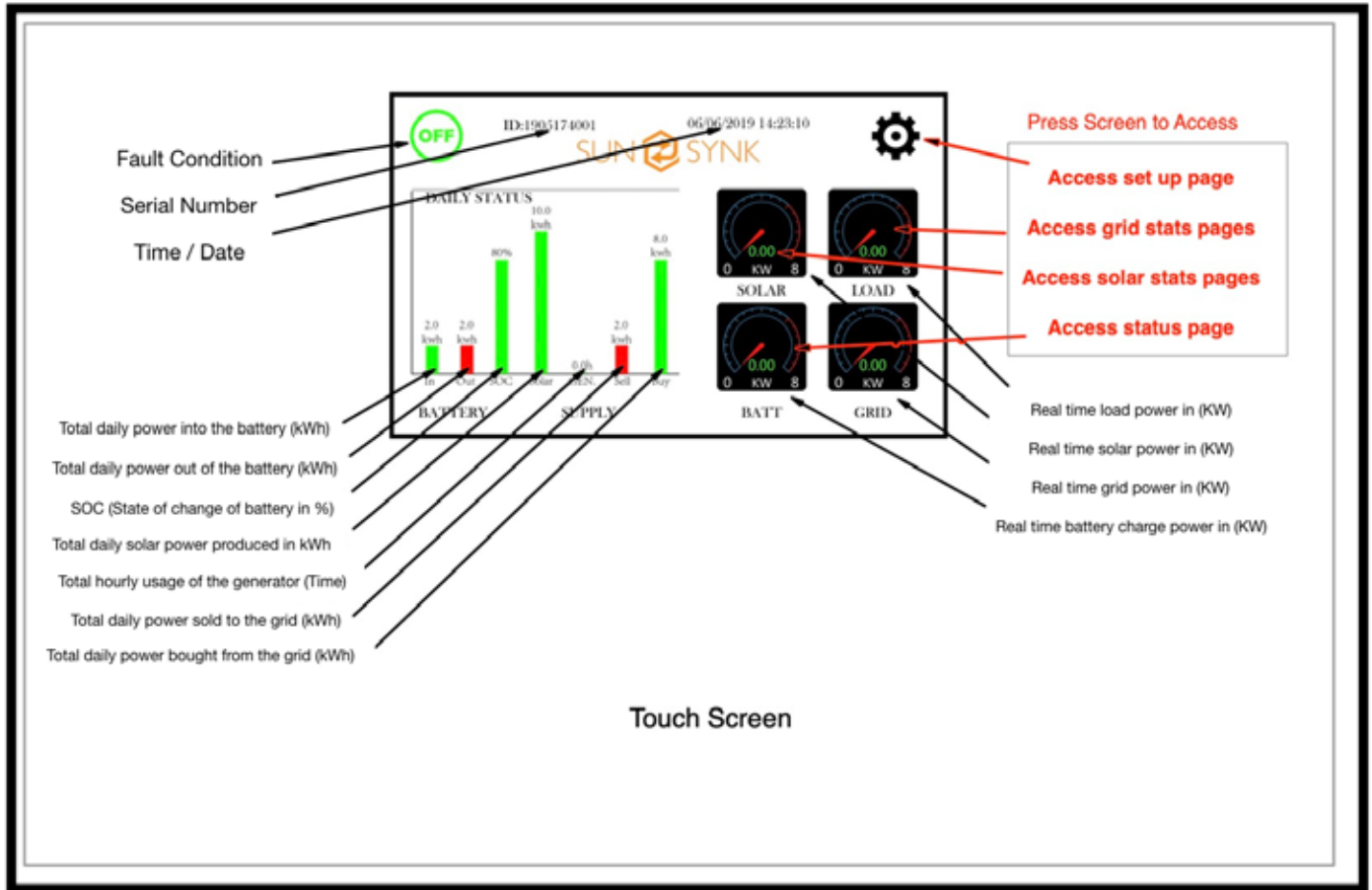

#### What this page displays

- Total daily power into the battery (kWh)
- Total daily power out of the battery (kWh)
- SOC (State of change of the battery) (%)
- Total daily solar power produced in (kWh)
- Total hourly usage of the generator (Time)
- Total daily power sold to the grid (kWh)
- Total daily power bought from the grid (kWh)
- Real time solar power in (kW)
- Real time load power in (kW)
- Real time battery charge power in (kW)
- Real time grid power in (kW)
- Serial number
- Time date
- Fault condition

#### What this page displays

- Access stats pages
- Access status page
- Access fault diagnostic page
- Access stats pages

#### 4.04 Status Page

Press battery icon on home page to access

Solar	Grid	INV	Load	Batt
447W	0W 50Hz	0W 50Hz	0W	-402W 52%
L1:272V 0.7A 216W	0V 0A HM:0W	230V 0.0A	230V	50.05V -8.04A 24.8C
L2:286V 0.8A 231W	LD:0W			DC:54.6C AC:33.8C

#### What this page displays

- Total solar power being produced
- MPPT 1 solar power voltage / current / Watts
- MPPT 2 solar power voltage / current / Watts
- Grid power
- Grid frequency
- Grid voltage
- Grid current
- Inverter power
- Inverter frequency

- Inverter voltage
- Inverter current
- Load power
- Load voltage
- Battery power charge/discharge
- Battery SOC
- Battery voltage
- Battery current
- Battery temperature (temperature sensor must be fitted)

**Solar Column:** Shows total PV power at the top and then details of each of the two MPPT's below L1 & L2 voltage.

**Grid Column:** Showing grid total power, frequency, voltage and current. When selling to grid the power is negative. When receiving from grid the power is positive. If the sign of the grid and HM powers are not the same when the PV is disconnected and the inverter is only taking energy from the grid and using the HM CT connected to limit-2 then please reverse the polarity of the HM current sensor. Important: See section on CT coil.

**Inverter Column:** Showing inverter total power, frequency, L1, L2, voltage, current and power.

**Load Column:** Showing total load power, load voltage and power on L1 and L2.

**Battery Column:** Showing total power from the battery, battery SOC, battery voltage, battery current (negative means charge, positive means discharge) battery temperature (shows zero if the battery temperature sensor is not connected). DC transformer temperature and AC heatsink temperature (when the temperature reaches 90°C it will show in red and start derating when it reaches 110°C. After that the inverter will shut down to allow it to cool).



## 4.05 Set-Up Page

Press top right hand button on home page to access

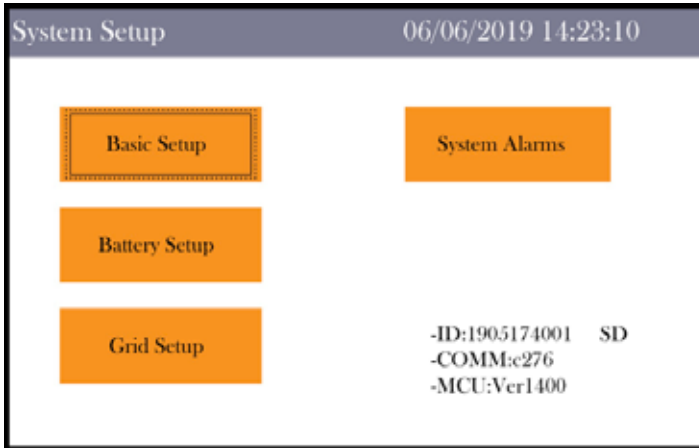

### What this page displays

- Serial number
- Software version
- Time & date
- MCU

### What you can do from this page

- Access the basic set up page (press basic setup)
- Access the battery setup page (press battery setup)
- Access the system alarms page (press system alarms)
- Access the grid set up page (press grid setup)

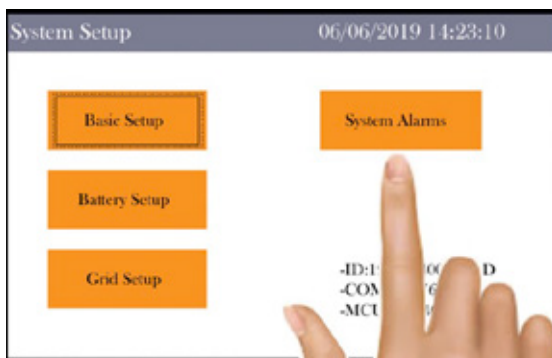

Press the icon to access the various pages

## 4.06 Basic Set-Up Page

Access from set-up page

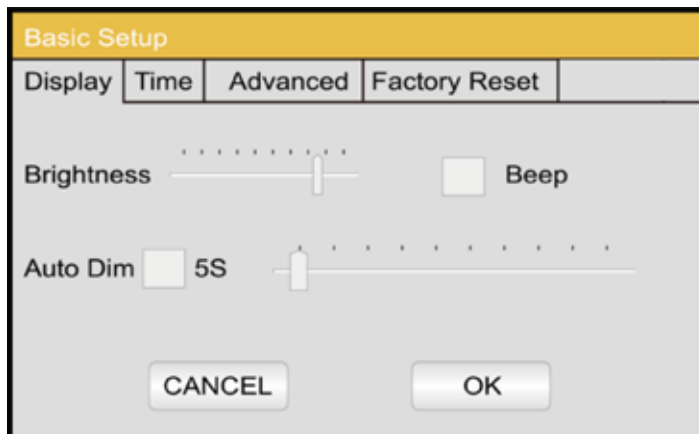

### What this page displays

- The basic set-up page
- Display brightness level
- Display if beep / buzzer is on or off
- Display if auto dim is on / off
- Display the auto dim off time

### What you can do from this page

- Switch beeper on or off by ticking box
- Adjust brightness level
- Switch auto dim mode on or off by ticking box
- Adjust auto-dim time

- Press ok to set

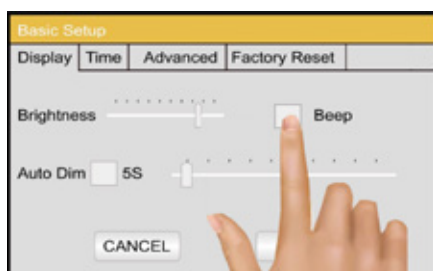

**Auto Dim:** If selected you can control the LCD display to dim after time selected.

**Beep:** By selecting this application the inverter will alarm by beeping to give warning signals in case the inverter has a fault. Please check the fault code on the LCD if beep occurs.

\*There is no 'Parallel' function in this inverter

## 4.07 Set Time (Clock)

Access from set-up page

Basic Setup

Display	Time	Advanced	Factory Reset
	Year	Month	Day
	2018	10	24
<input type="checkbox"/> AM/PM	Hour	Minute	Second
	01	53	17
CANCEL		OK	

### What this page displays

- Time
- Date
- AM/PM

### What you can do from this page

- Adjust / set time
- Adjust / set date
- Adjust / set AM/PM

- Touch the screen where you wish to change
- Then move the number up and down via the up down buttons
- Press ok to set.

Basic Setup

Display	Time	Advanced	Factory Reset
	Year	Month	Day
	2018	10	24
<input type="checkbox"/> AM/PM	Hour	Minute	Second
	01	53	17
CANCEL		OK	

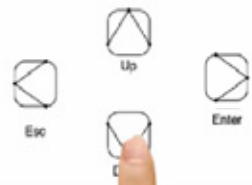

## 4.08 Power Shaving

Access via setup page



### What this page displays

- Solar Arc fault is on/off
- Generator peak shaving is on/off
- Grid peak shaving is on/off

### What you can do from this page

- Switch on Solar Arc fault and clear solar Arc fault. This indicates a favour if the solar cables have a poor connection, this can help prevent fire risk.
- Switch on generator and or grid peak power saving and set the power level with the power shaving will operate.

**Peak Shaving:** This is a technique that is used to reduce electrical power consumption during periods of maximum demand on the power utility. Thus saving substantial amounts of money due to peaking charges.

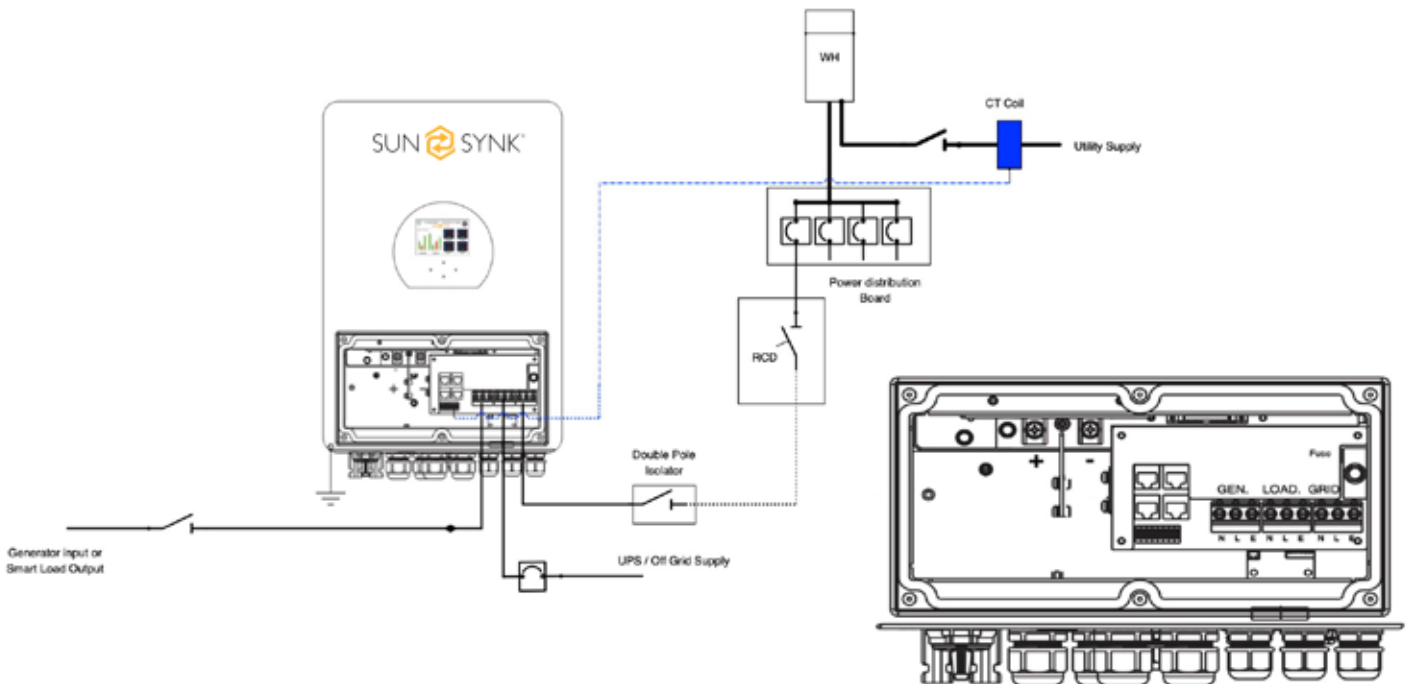

## 4.09 Factory Reset and Lock Code

Access via setup page



### What this page displays

- Reset status
- If lock code is used

### What you can do from this page

- Full factory reset
- System diagnostics
- Self test
- Change or set lock code

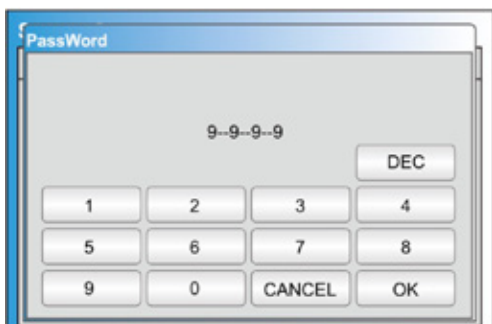

- Press ok to set

**Factory Reset:** Reset all parameters on inverter

**Lock out all changes:** Enable this menu for setting parameters which require locking and cannot be reset. System self check and test mode reserve engineers only.

Before conducting a successful factory reset and locking the system to keep all changes you need to type in a password to enable the setting. Password for factory settings is 9999 and for lockout it is 7777.

## 4.10 Battery Setup Home Page

Access via setup page

### What this page displays

- Battery capacity in (Ah) min AGM battery 200Ah  
Min li-batt 100 Ah
- Max battery charge current (Amps)
- Max battery discharge current (Amps) this should be 20% of the Ah rating.
- TEMPCO settings - temperature coefficient  
"the error introduced by a change in temperature."

### What you can do from this page

- Use battery voltage for all settings (V)
- Use battery SOC for all settings (%)
- No battery - tick this if no battery is connected to the system.
- BMS setting
- Active battery - this feature will help recover a battery that is 100%. Discharged by slowly changing from the solar array. Until the battery reaches a point where it can change normally.

### IMPORTANT TO PROTECT YOUR BATTERY & INVERTER

200Ah AGM battery max charge/discharge current 40Amps  
 400Ah AGM battery max charge/discharge current 80Amps  
 100Ah AGM battery max charge/discharge current 75Amps  
 200Ah AGM battery max charge/discharge current 100Amps

## 4.11 Generator & Battery Change Page

Access via setup page

### What this page displays

- Generator start voltage / or SOC %
- Grid power start voltage / or SOC %
- Float is for AGM battery 55.20V
- Absorption is for AGM battery 57.60V
- Float V is the voltage at which a battery is maintained after being fully charged.
- Absorption V the level of charge that can be applied without overheating the battery.
- Equalization V 58.80
- Equalizing charge / overcharge to remove sulphate crystals that build up on the plates over time.

### What you can do from this page

- Tick gen charge to change the batteries from the gen I/P
- Tick grid charge to change the batteries from the grid I/P
- Tick gen change signal to auto switch a relay box
- Tick grid change signal to auto switch a relay box

**Do not run this too often as its will damage the battery.**

Press okay to set.

## 4.12 Battery Discharge Page

Access via setup page

Batt Setup				
Batt	Charge	Discharge	Smart Load	WindTurbine
Shutdown	41.0V	10%	Batt Resistance	25mOhms
Low Batt	45.0V	30%	Batt Charge Efficiency	96.0%
Restart	52.0V	80%		
CANCEL		OK		

### What this page displays

- Inverter shut down voltage as a voltage or %
- Inverter low batt warning voltage or %
- Restart voltage as a voltage or %

Note Shut down takes the inverter to standby

It will not completely shut the inverter down

Total shutdown is below 19v

### What you can do from this page

- Adjust battery shut down (voltage or %)
- Adjust low battery warning (voltage or %)
- Adjust restart (voltage or %)
- Set the battery resistance
- Set the battery charge efficiency
- PRESS OK TO SET

The voltage displayed on the Sunsynk Parity Inverter will vary depending on weather the inverter is:

- A. Charging the batteries
- B. Discharging the batteries

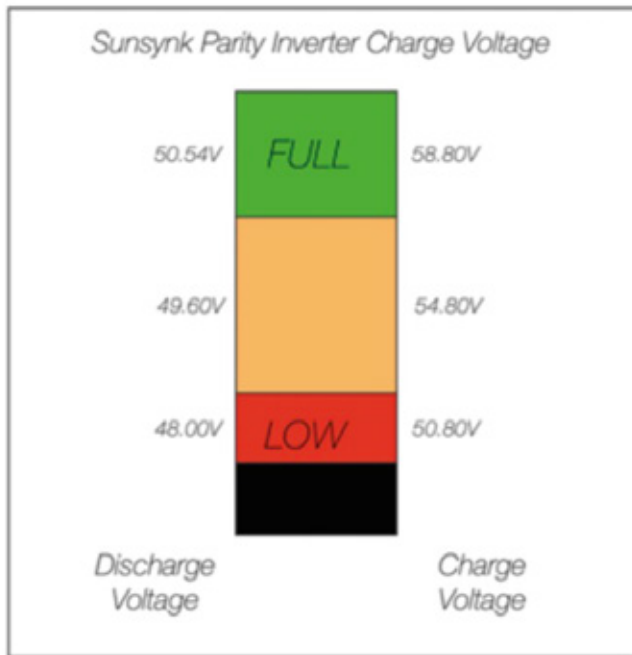

As we use 48V these figures are x 4 :-

- Fully Charged 50.54V (Discharge Mode)
- Fully Charged 58.80V (Charge Mode)
- 75% Charged 49.60V (Discharge Mode)
- 75% Charged 54.80V (Charge Mode)
- 25% Charged 48.00V (Discharge Mode)
- 25% Charged 50.80V (Charge Mode)
- Completely Discharged 47.50V

Setting the cut-off higher is better for the batteries.

The batteries normally used in the recommended Sunsynk systems are AGM lead acid or lithium battery bank. ('AGM' The Absorbed Glass Matt construction allows the electrolyte to be suspended in close proximity with the plates active material. In theory, this enhances both the discharge and recharge efficiency.)

### State of Charge

**BULK:** Stage involves about 80% of the recharge, wherein the charger current is held constant (in a constant current charger), and voltage increases. The properly sized charger will give the battery as much current as it will accept up to charger capacity (25% of battery capacity in amp hours)

**ABSORPTION:** (The remaining 20%, approximately) has the charger holding the voltage at the charger's absorption voltage (between 14.1 VDC and 14.8 VDC, depending on charger set points) and decreasing the current until the battery is fully charged.

**FLOAT:** The charge voltage is reduced to between 13.0 VDC and 13.8 VDC and held constant, while the current is reduced to less than 1% of battery capacity. This mode can be used to maintain a fully charged battery indefinitely.

**EQUALISATION:** This is essentially a controlled over charge (the peak voltage the charger) attains at the end of the BULK mode (absorption voltage) an equalisation voltage, but technically it's not. Higher capacity wet (flooded) batteries sometimes benefit from this procedure, particularly the physically tall batteries. The electrolyte in a wet battery can stratify over time, if not cycled occasionally.

In equalisation, the voltage is brought up above typical peak charging voltage well into the gassing stage, and held for a fixed (but limited) period. This stirs up the chemistry in the entire battery, "equalising" the strength of the electrolyte, and knocking off any loose sulphating that may be on the battery plates.

### 4.13 Smart Load

Access via setup page

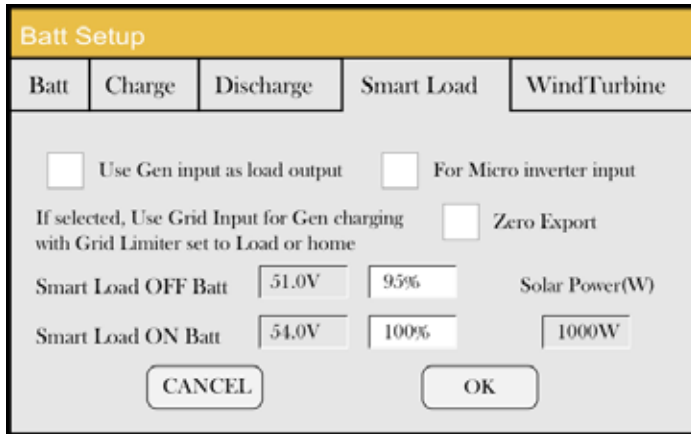

#### What this page displays

- This controls the gen (Aux) input or output

#### What you can do from this page

- Tick this (use gen input as a load output)
- Tick this (use gen input for micro inverter)
- Tick this (use grid input for generator charging)
- Zero EXPORT (stop power flowing back to The generator)
- Set smart load on battery V / %
- Set smart load off battery V / %
- Set smart load max power in Watts

**NOTE: WHEN USING IN INPUT AS A LOAD OUTPUT - THIS IS KNOWN AS SMART LOAD**

Press okay to set.

**Smart Load:** A 'smart load' is a setting that draws excess power when the battery storage is full and passes it to household utilities such as water heaters and air conditioners.

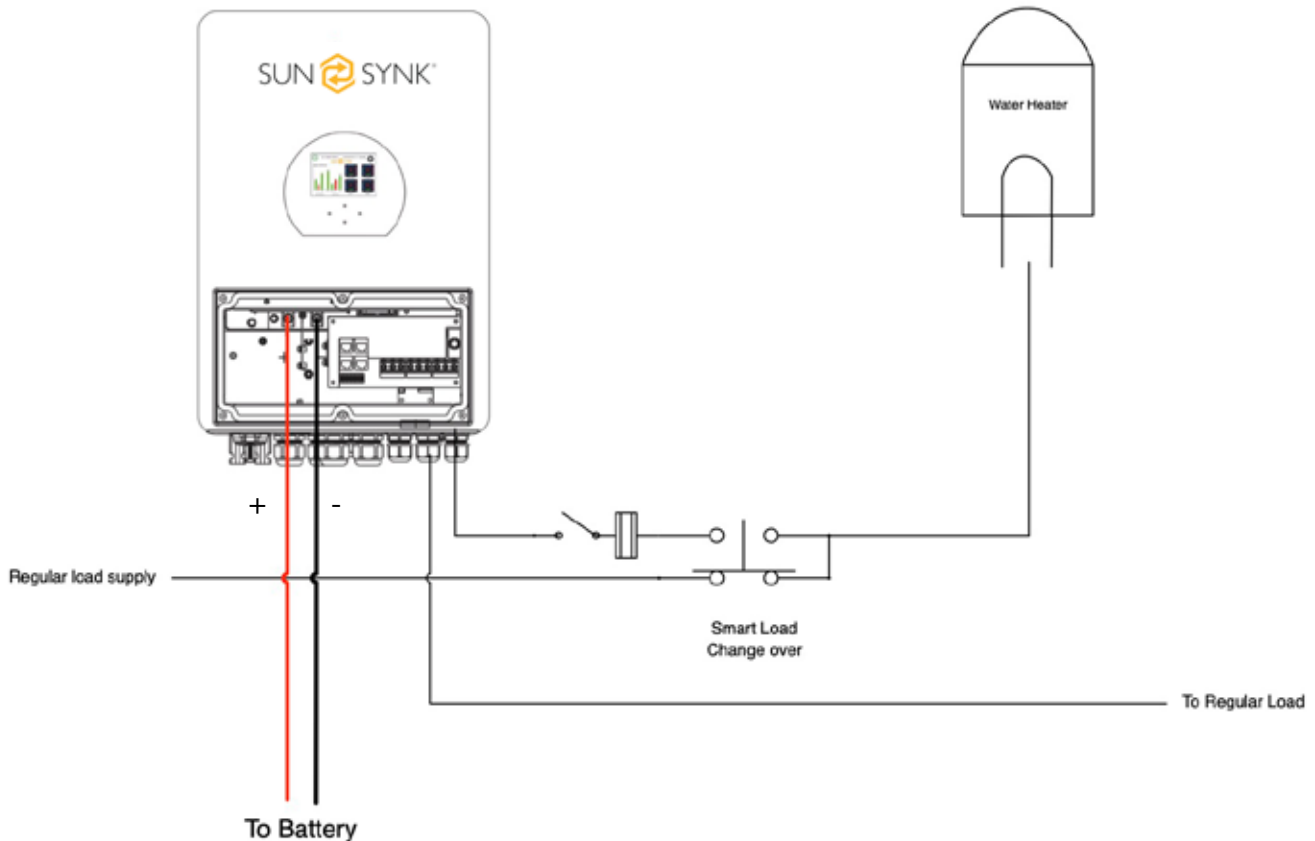



### 4.14 Wind Turbine Setup Page

Access via setup page

Batt Setup					
Batt	Charge	Discharge	Smart Load	WindTurbine	
<input type="checkbox"/> DC1 for WindTurbine		<input type="checkbox"/> DC2 for WindTurbine			
V1	0V	0.0A	V7	0V	0.0A
V2	0V	0.0A	V8	0V	0.0A
V3	0V	0.0A	V9	0V	0.0A
V4	0V	0.0A	V10	0V	0.0A
V5	0V	0.0A	V11	0V	0.0A
V6	0V	0.0A	V12	0V	0.0A

OK

CANCEL

#### What this page displays

- If one or both MPPTs are used for WT input

#### What you can do from this page

- Set profile of the wind turbine - the higher the voltage the faster the wind turbine as it goes faster we can increase the current draw which acts as braking system.

Press okay to set.

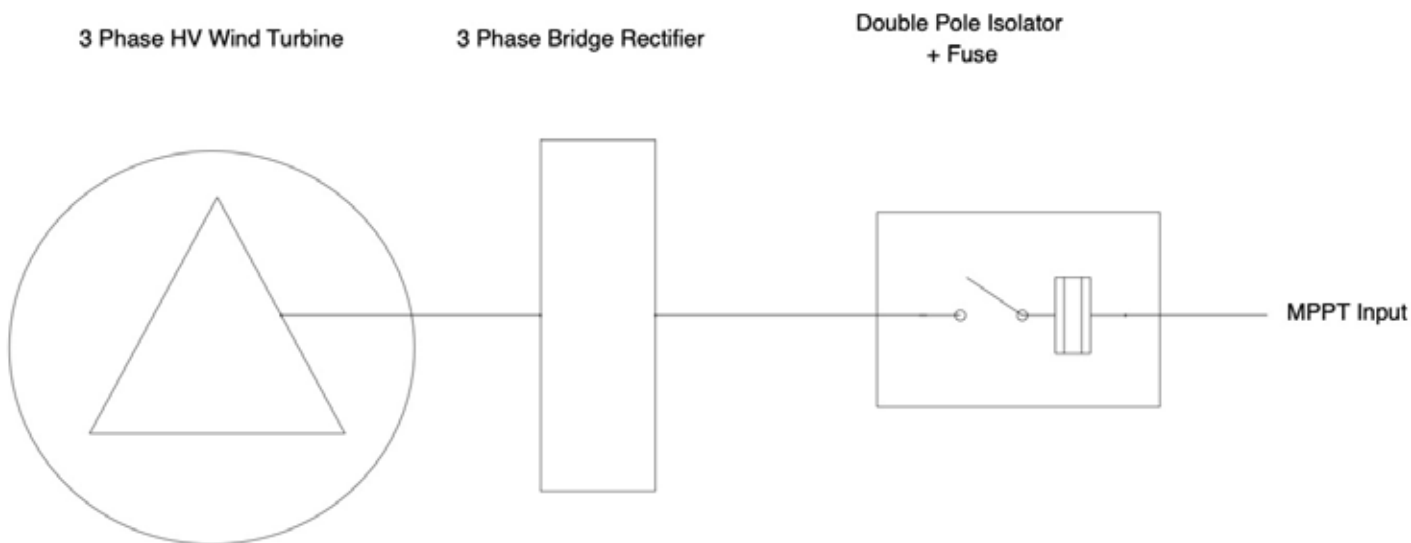

### 4.15 Program Charge / Discharge Times Page

Access via setup page

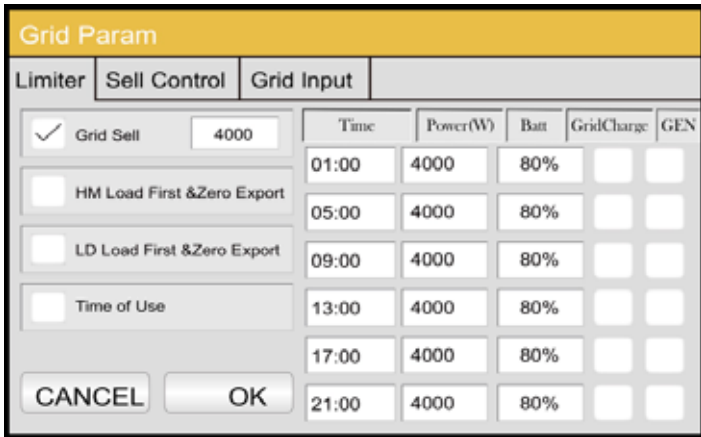

#### What this page displays

- Sell the power to the grid
- Limit power to the home (grid & load) with zero export
- Limit power to the load with zero export
- Time of use settings

#### What you can do from this page

- Time is real time when battery will charge or discharge
- Power is the power limiter
- Battery is the 80% which can discharge
- Grid charge tick to charge from grid
- Gen charge tick to charge from gen
- Un-Tick is the time of discharge

#### This will also override the auto gen start

This is used when you need the battery to charge at certain time each day or need the battery to discharge at a specific time each day.

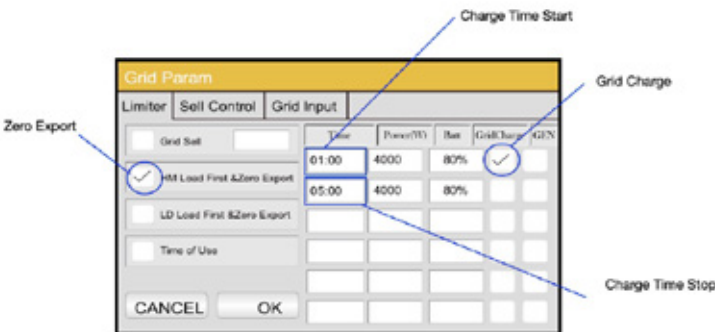

### 4.16 Gen to Grid + Reconnect Time, Sell Control (Export)

Access via setup page

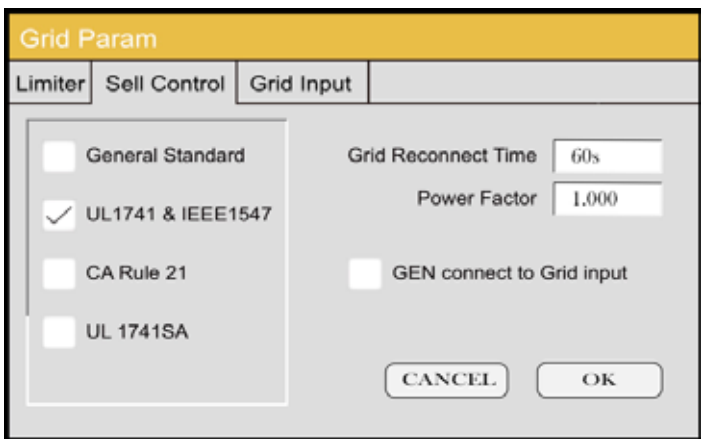

#### What this page displays

- USA general standard
- UL 1741
- USA CA rule 21
- USA UL 1741 SA

#### What you can do from this page

- Grid reconnect time after loss of grid
- Power factor compensation
- Tick If connecting gen to grid input

Normal ramp rate: Reserve

Voltage and HZ ride through: Reserve

Soft start ramp rate: Reserve

Power factor: Reserve

Grid re-connect time: Time To

Connect to grid again: Default is 60s.

UL 1741 & IEEE 1547: US standard

Voltage frequency, if not selected need to set voltage and frequency on settings page.

## 4.17 Grid Supply Voltage and Frequency - Grid Supply Page

Access via setup page

**Grid Param**

Limiter | Sell Control | Grid Input

Grid Frequency  50Hz  
 60Hz

Grid Type  
 220V Single Phase  
 120V/240V Split Phase  
 120v

Protect Param  
Grid Vol High: 264.0V  
Grid Vol Low: 211.0V  
Grid Hz High: 60.5Hz  
Grid Hz Low: 45.0Hz

CANCEL OK

### What this page displays

- Grid frequency setting
- Grid type (normally 220V single phase)  
120V and split phase is for USA

### What you can do from this page

- Change grid frequency setting (normally 50 Hz)
- Max grid input voltage set
- Min grid input voltage set
- Max grid frequency Hz
- Min grid frequency Hz

Press okay to set.

## 4.18 Solar Power Produced - Solar Power Produced Per Day

Access via home page

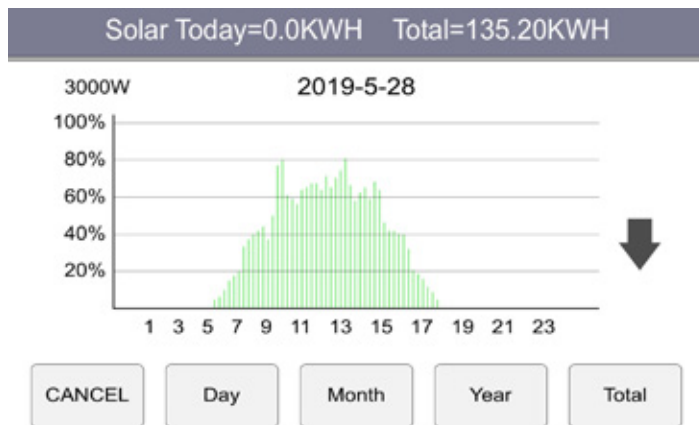

### What this page displays

- Daily solar power that has been produced in kWh

### What you can do from this page

- Daily solar power
  - Monthly accumulative solar power
  - Yearly accumulative solar power
  - Total accumulative solar power
- Press okay to set.

## Solar Power Per Month

Access via solar power produced page

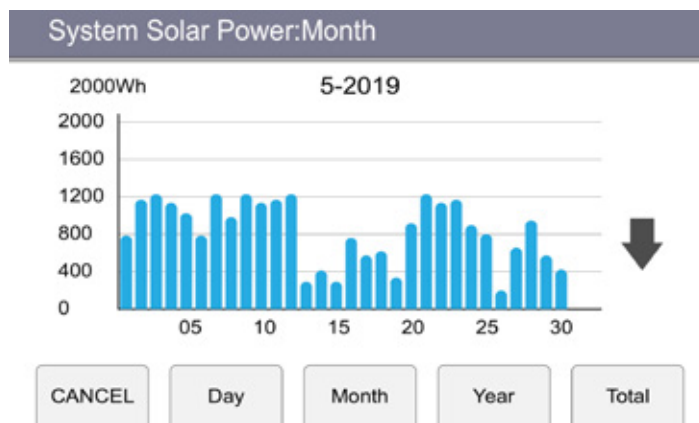

### What this page displays

- Monthly accumulative solar power

### What you can do from this page

- Daily solar power
  - Monthly accumulative solar power
  - Yearly accumulative solar power
  - Total accumulative solar power
- Press okay to set.

### Solar Power Production Per Year

Access via solar power produced page

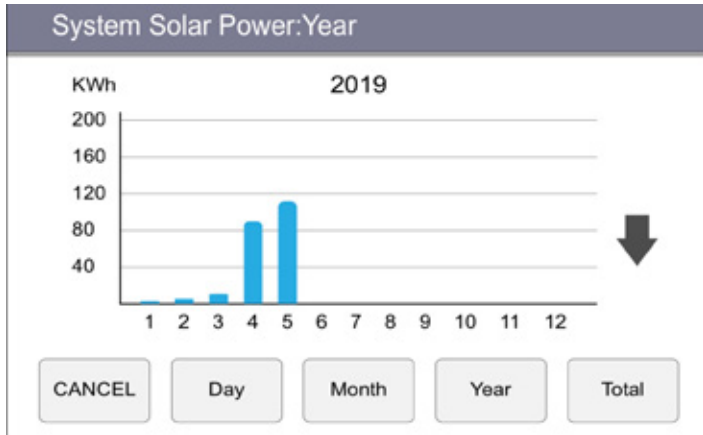

#### What this page displays

- Yearly accumulative solar power

#### What you can do from this page

- Daily solar power
- Monthly accumulative solar power
- Yearly accumulative solar power
- Total accumulative solar power

Press okay to set.

### Total Solar Power Produced

Access via solar power produced page

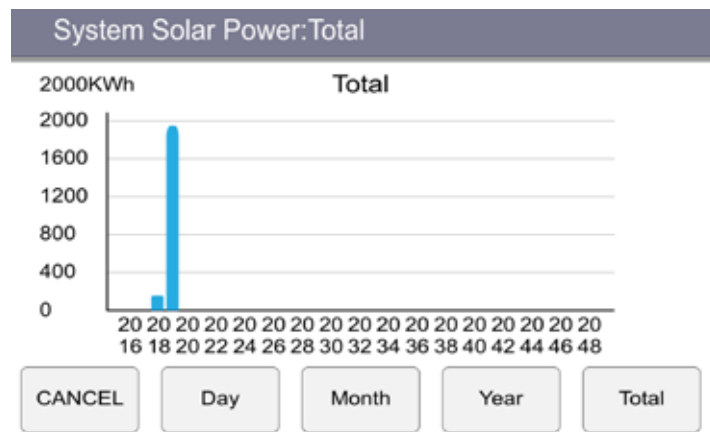

#### What this page displays

- Total accumulative solar power

#### What you can do from this page

- Daily solar power
- Monthly accumulative solar power
- Yearly accumulative solar power
- Total accumulative solar power

Press okay to set.

### Grid Power Per Day - Grid Power Per Day

Access via home page

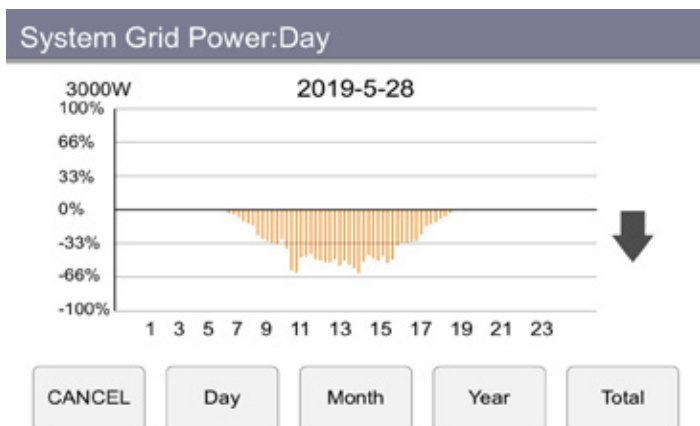

#### What this page displays

- Daily grid power

#### What you can do from this page

- Daily grid power
- Monthly accumulative grid power
- Yearly accumulative grid power
- Total accumulative grid power

Press okay to set.

### Grid Power Per Month

Access via grid power produced page

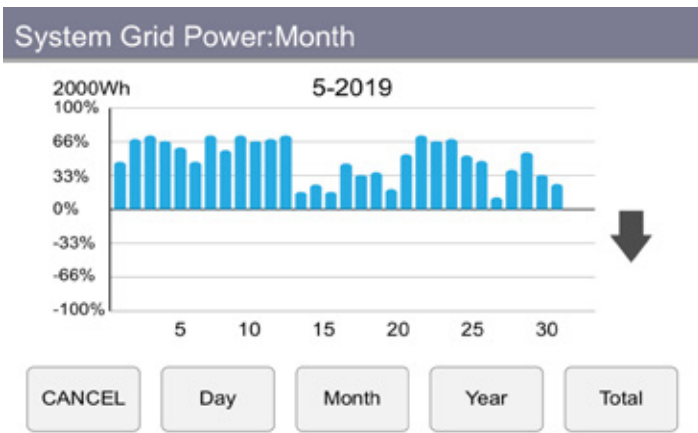

#### What this page displays

- Monthly accumulative grid power

#### What you can do from this page

- Daily grid power
- Monthly accumulative grid power
- Yearly accumulative grid power
- Total accumulative grid power

Press okay to set.

### Grid Power Per Year

Access via grid power produced page

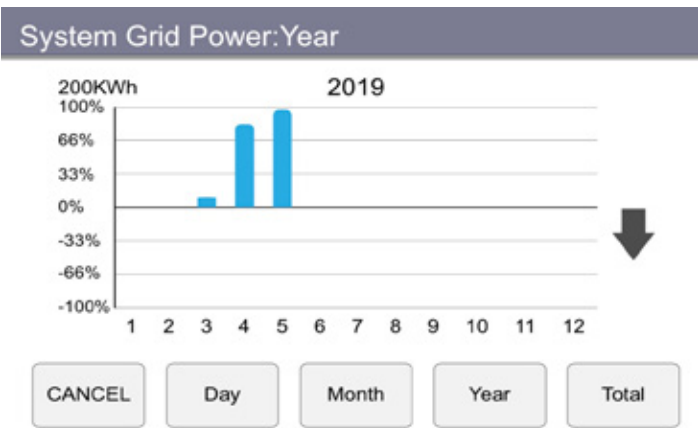

#### What this page displays

- Monthly accumulative grid power

#### What you can do from this page

- Monthly accumulative grid power

Press okay to set.

### Total System Grid Power

Access via grid power produced page

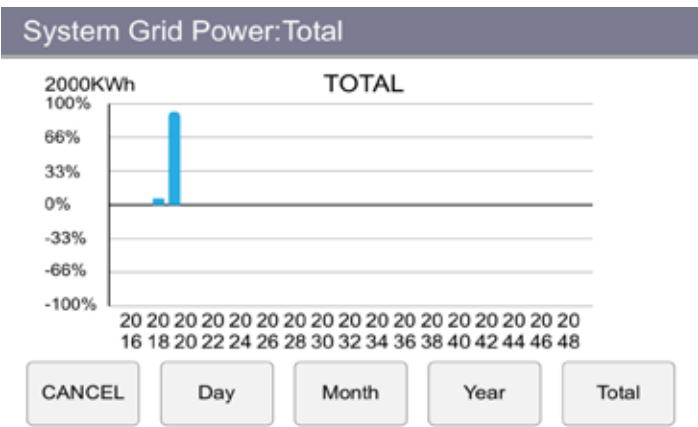

#### What this page displays

- Monthly accumulative grid power

#### What you can do from this page

- Monthly accumulative grid power

Press okay to set.

## 5.00 Fault Diagnostic - Fault Home Page

Press Esc button from any page to access

System Alarms		06/06/2019 14:23:10
Alarms Code	Occurred	
F56 DC_VoltLow_Fault	2018-10-24 01:07	
F56 DC_VoltLow_Fault	2018-10-24 01:07	
F56 DC_VoltLow_Fault	2018-10-24 01:00	
F56 DC_VoltLow_Fault	2018-10-24 00:55	
F56 DC_VoltLow_Fault	2018-10-24 00:43	
F56 DC_VoltLow_Fault	2018-10-24 00:10	
F56 DC_VoltLow_Fault	2018-10-24 00:08	
F56 DC_VoltLow_Fault	2018-10-24 00:07	

## 6.00 Modes of Operation

### 6.01 On-Grid No PV - MODES OF OPERATION

MODE 1 (on NO PV) power saver

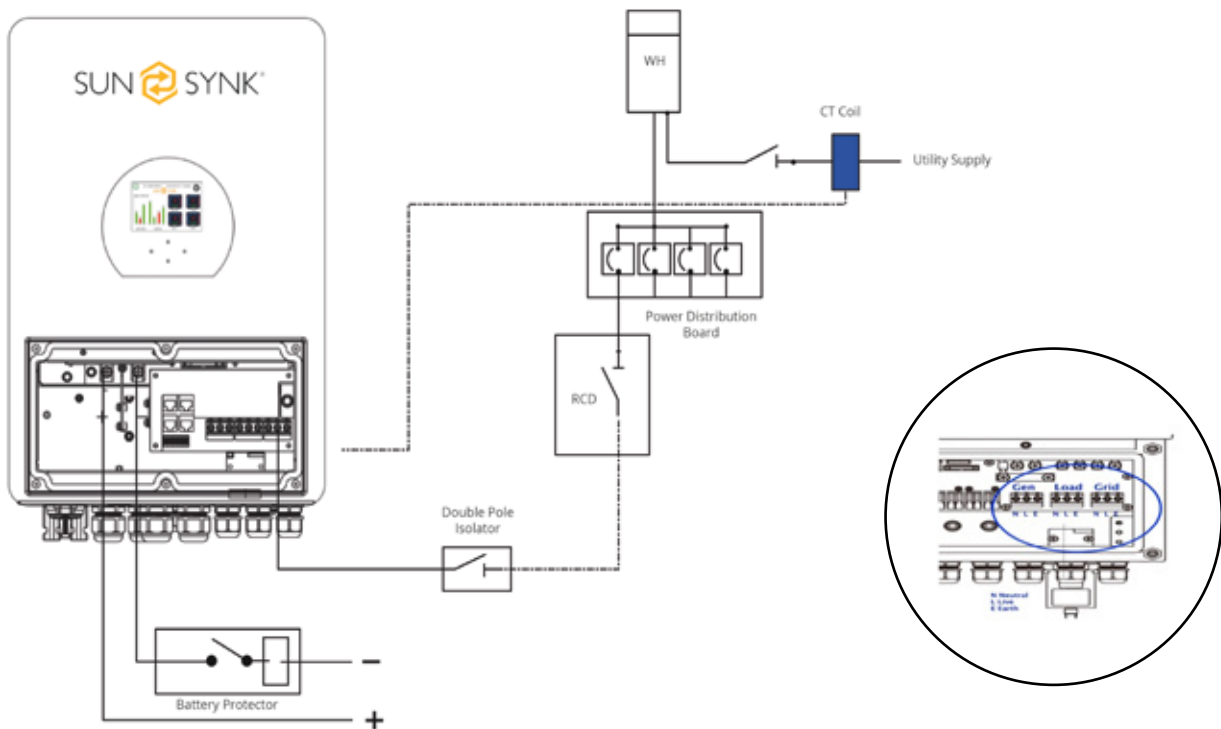

This system can charge and discharge the battery storage with the aim of buying power from the grid at night when it is cheapest and using it during the day. No re-wiring is required as the inverter sits next to the mains distribution board and can be wired directly to the board via suitable isolators / disconnectors and RCD.

Basic Setup			
Display	Time	Advanced	Factory Reset
	Year	Month	Day
	2018	10	24
<input type="checkbox"/> AM/PM	Hour	Minute	Second
	01	53	17
CANCEL		OK	

1. Set time and date

Batt Setup				
Batt	Charge	Discharge	Smart Load	WindTurbine
Batt Capacity	400Ah		<input type="checkbox"/> Use Bat V charged	
Max A Charge	40A		<input checked="" type="checkbox"/> Use Bat % Charged	
Max A discharge	60A		<input type="checkbox"/> No Battery	
TEMPCO	-5mV/C/Cell		<input type="checkbox"/> BMS Lithium Bat	01
			<input type="checkbox"/> Activate Battery	
CANCEL		OK		

2. Set battery capacity

Batt Setup				
Batt	Charge	Discharge	Smart Load	WindTurbine
Start V	30%	30%	Float V	55.2V
A	40A	40A	Absorption V	57.6V
<input type="checkbox"/> Gen Charge	<input checked="" type="checkbox"/> Grid Charge		Equalization V	58.8V
<input type="checkbox"/> Charge stop	<input type="checkbox"/> Charge stop			90 days
GEN MAX RUN TIME	0.0hours			2.0 hours
GEN DOWN TIME	0.5hours		CANCEL	OK

3. Set grid charge and charge current

Batt Setup				
Batt	Charge	Discharge	Smart Load	WindTurbine
Shutdown	41.0V	10%	Batt Resistance	2.5mOhms
Low Batt	45.0V	30%	Batt Charge Efficiency	96.0%
Restart	52.0V	80%		
CANCEL		OK		

4. Set shutdown voltage

Grid Param		
Limiter	Sell Control	Grid Input
Grid Frequency	<input checked="" type="checkbox"/> 50Hz	
	<input type="checkbox"/> 60Hz	
Grid Type	<input checked="" type="checkbox"/> 220V Single Phase	
	<input type="checkbox"/> 120V/240V Split Phase	
	<input type="checkbox"/> 120v	
Protect Param		
Grid Vol High	264.0V	
Grid Vol Low	211.0V	
Grid Hz High	60.5Hz	
Grid Hz Low	45.0Hz	
CANCEL		OK

5. Set voltage and frequency

Grid Param						
Limiter	Sell Control	Grid Input	Time	Power(W)	Bat	GridCharge
<input type="checkbox"/> Grid Sell	4000		01:00	4000	80%	<input checked="" type="checkbox"/>
<input checked="" type="checkbox"/> HM Load First & Zero Export			05:00	4000	80%	<input checked="" type="checkbox"/>
<input type="checkbox"/> LD Load First & Zero Export			09:00	4000	80%	<input type="checkbox"/>
Time of Use			13:00	4000	80%	<input type="checkbox"/>
			17:00	4000	80%	<input type="checkbox"/>
			21:00	4000	80%	<input type="checkbox"/>
CANCEL		OK				

6. Set HM load & zero export, set grid charge and discharge time

## 6.02 On Grid with PV - MODES OF OPERATION

### MODE 2 (ON GRID with Solar PV)

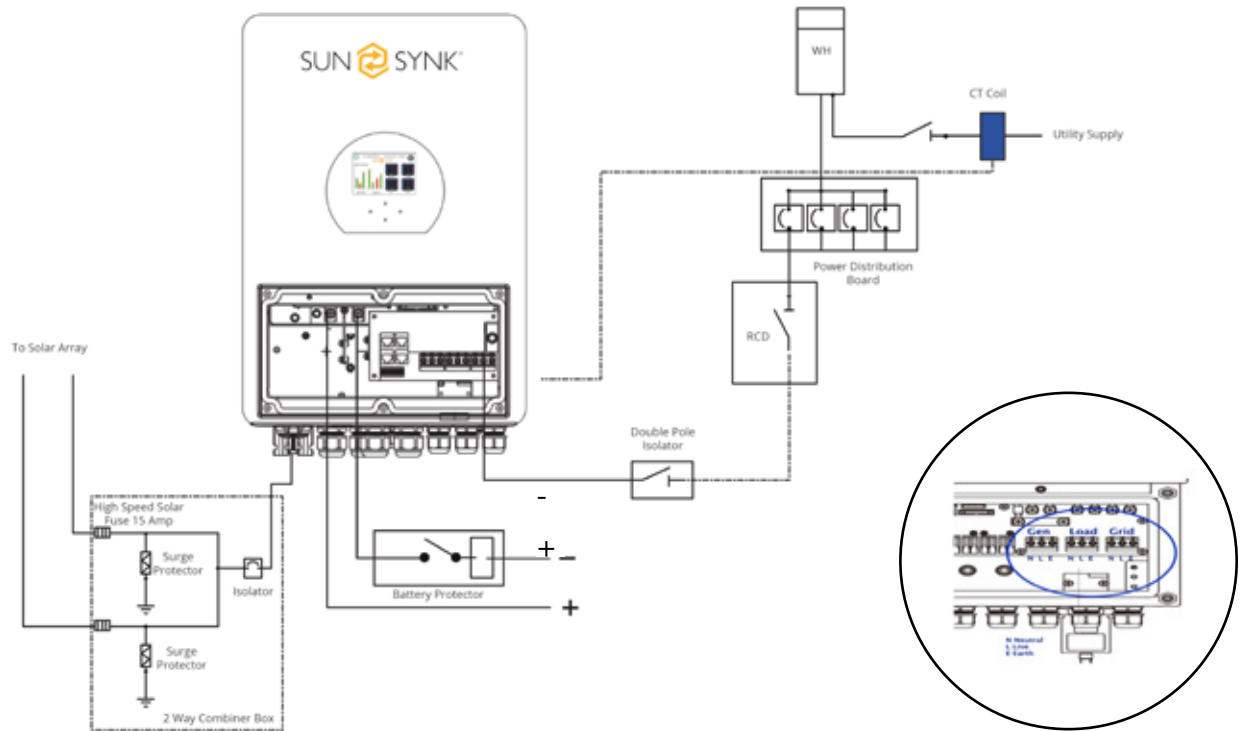

This system can charge the battery storage with excess solar power. It is very similar to Mode 1 in that it is connected to the mains grid, however it also takes power from the solar array during the daylight hours. This means there is the ability to store power both at night and during the day.

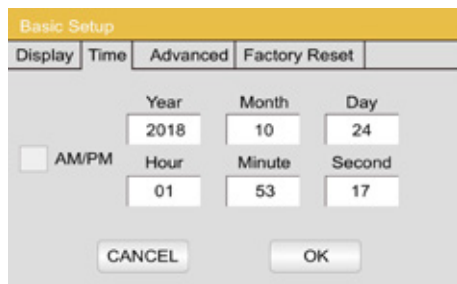

1. Set time and date

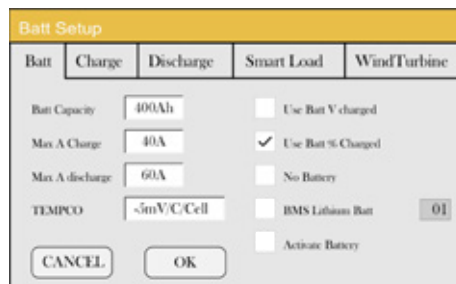

2. Set battery capacity

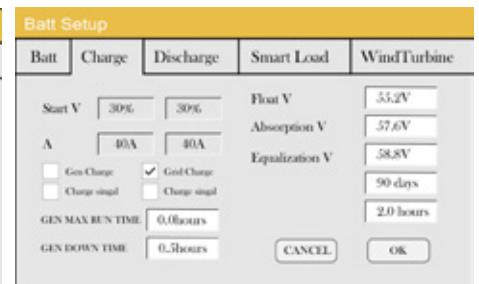

3. Set grid charge and charge current

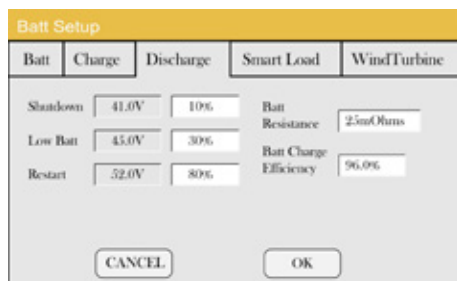

4. Set shutdown voltage

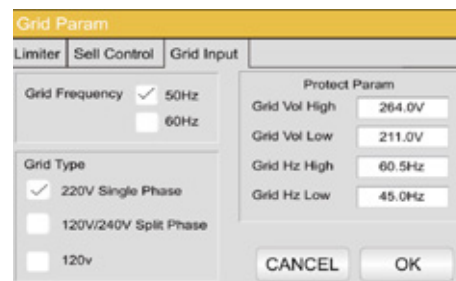

5. Set voltage and frequency

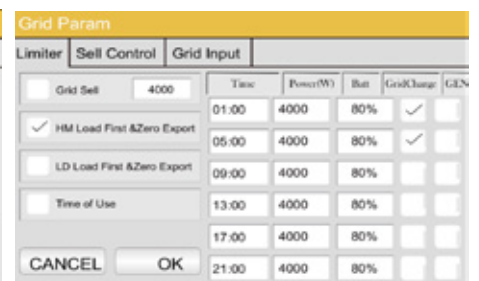

6. Set HM load & zero export, set grid charge and discharge time



### 6.03 On Grid with UPS - MODES OF OPERATION

#### MODE 3 (ON GRID with UPS)

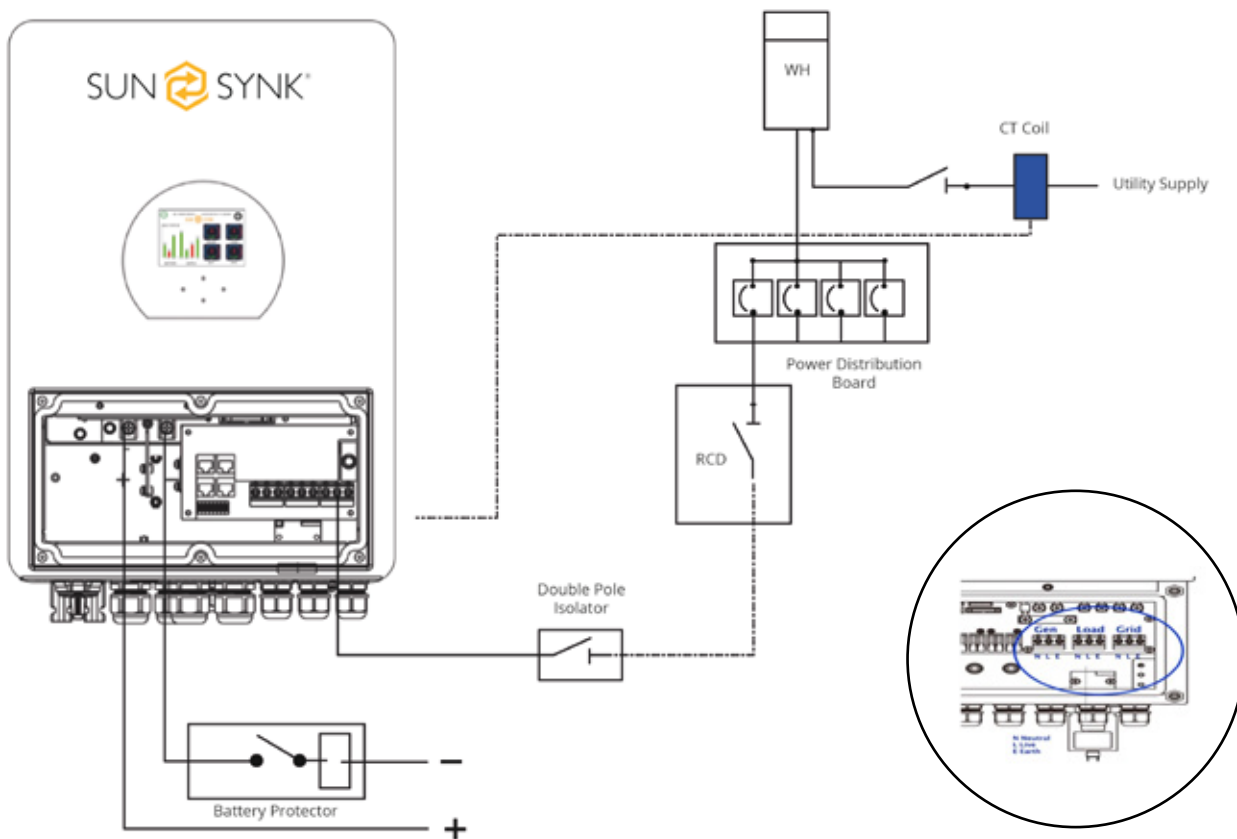

Uninterrupted power supply (UPS) mode is sometimes referred to as 'backup' mode. If there is any failure with the grid network then the system will isolate itself from the grid and continue to provide power to any pre-set loads.

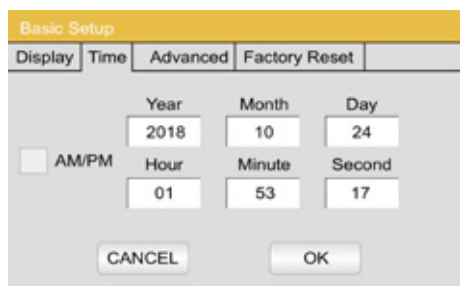

1. Set time and date

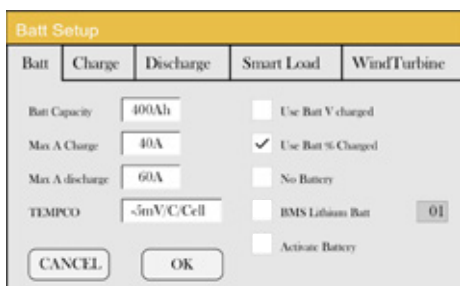

2. Set battery capacity

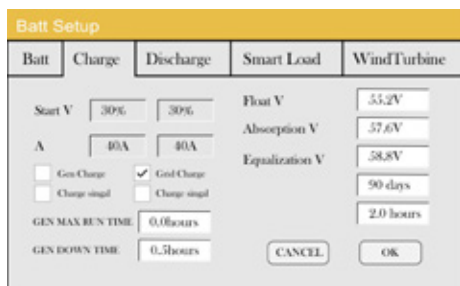

3. Set grid charge and charge current

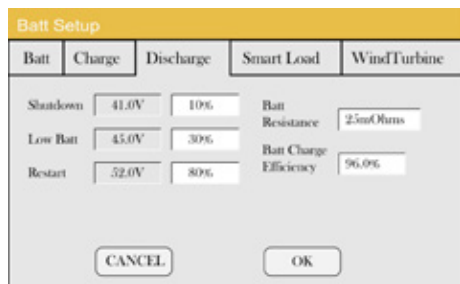

4. Set shutdown voltage

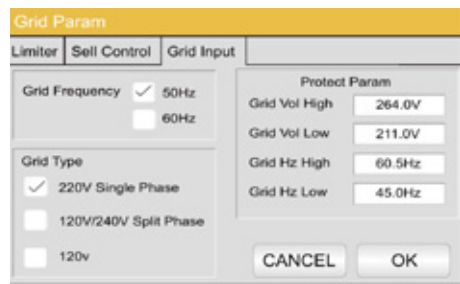

5. Set voltage and frequency

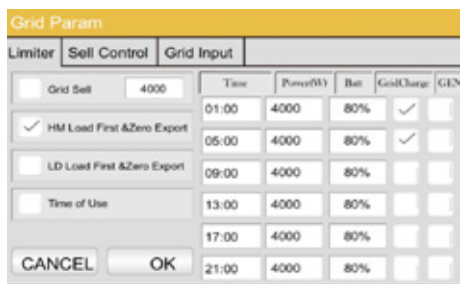

6. Set HM load & zero export, set grid charge and discharge time

## 6.04 Off-Grid with Solar - MODES OF OPERATION

### MODE 4 (off-grid with solar)

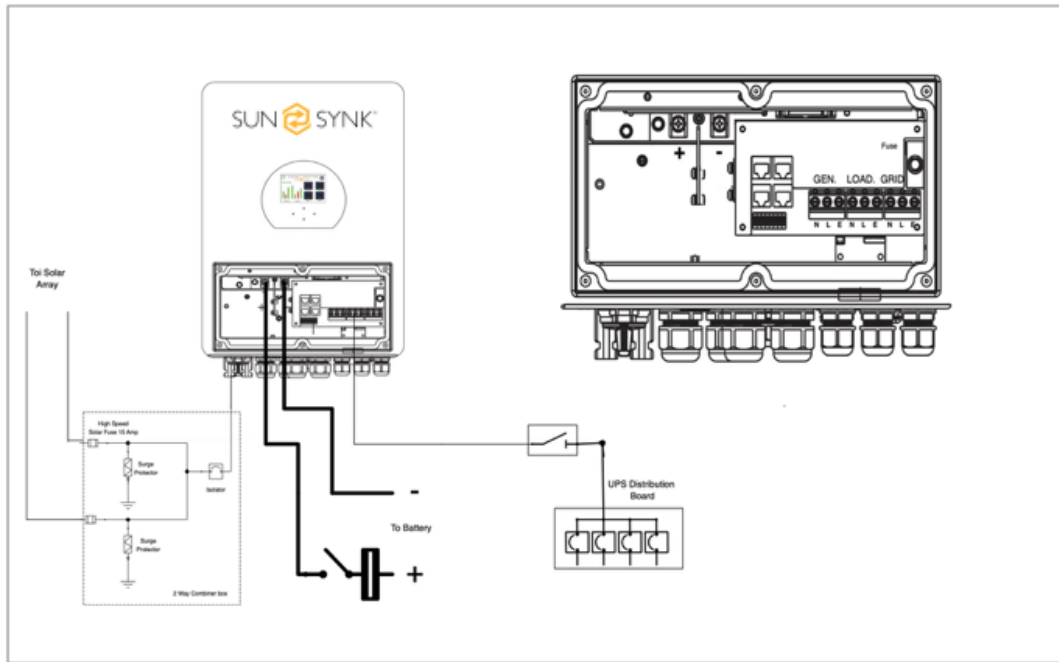

The off-grid system is designed for remote locations or for those users who do not want to be connected to the grid. The LCD display will provide a clear set of readings on the state of the battery storage and this can also be viewed remotely via the wi-fi connection.

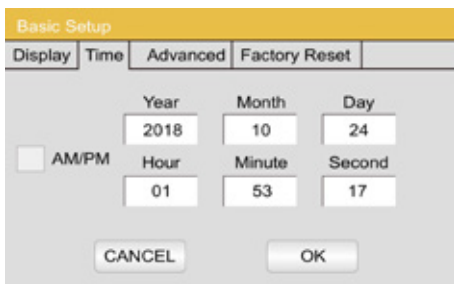

1. Set time and date

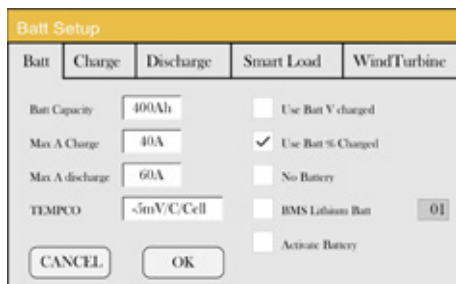

2. Set battery capacity

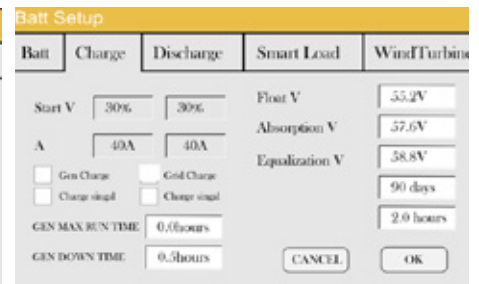

3. Un-tick charge from grid

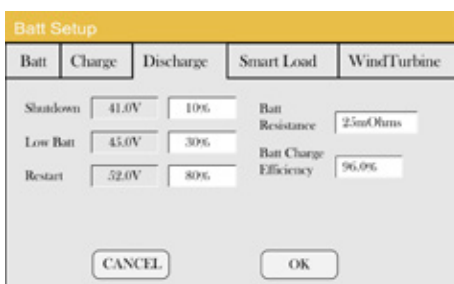

4. Set shutdown voltage

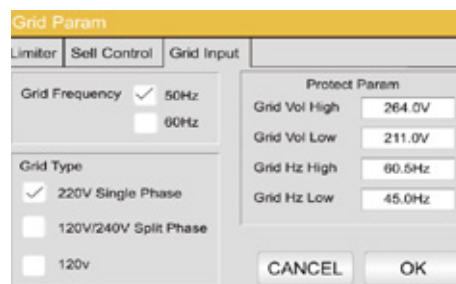

5. Set voltage and frequency

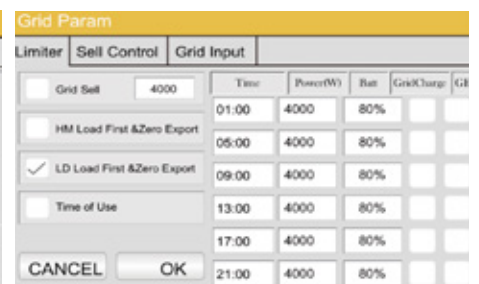

6. Set LD load

## 6.05 Off-Grid and Smart Load - MODES OF OPERATION

MODE 5 (off-grid with smart load)

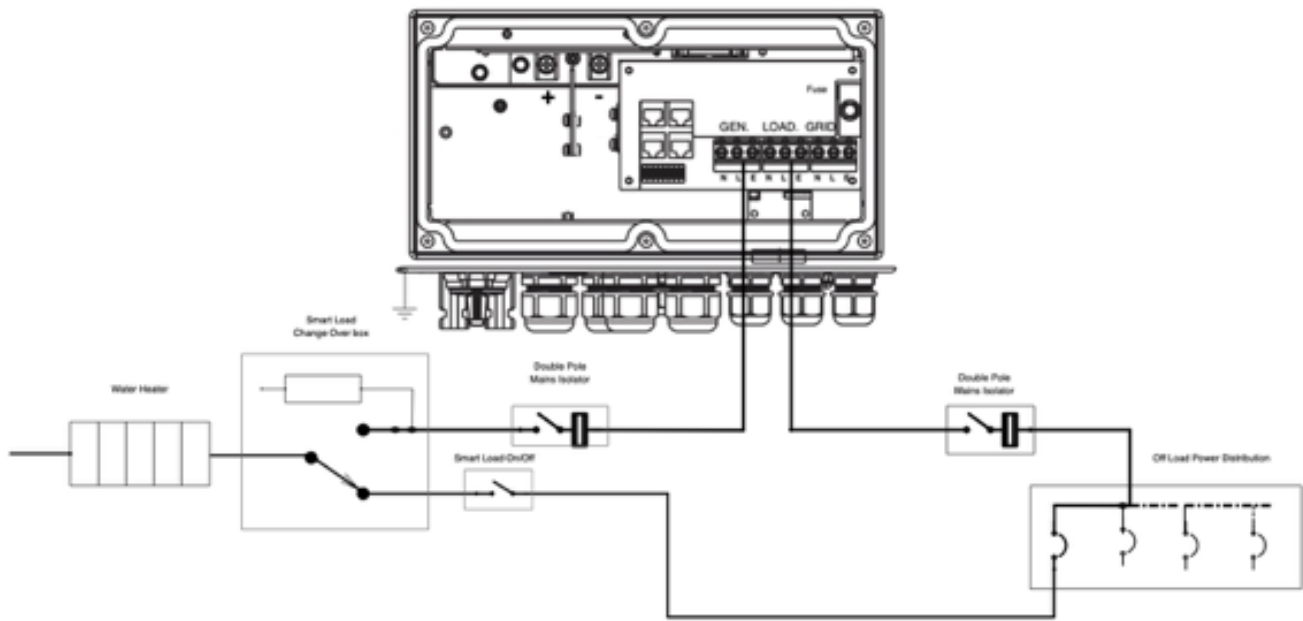

\*\* To use smart load you must:-

1. Connect the smart load to the Gen connections, Ensure you have a suitable MCB and disconnecter
2. Select on smart load page " Use Gen input as load output "
3. Set the battery level must reach before switching on
4. Set battery level discharge before switching off
5. Select the amount of power allowed to go to the smart load, This should be no more than your PV array size

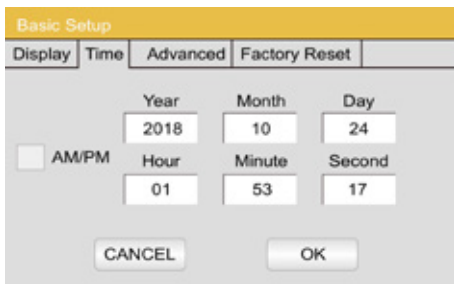

1. Set time and date

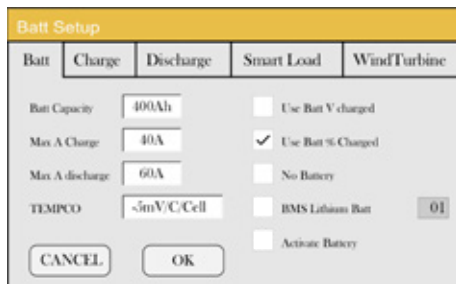

2. Set battery capacity

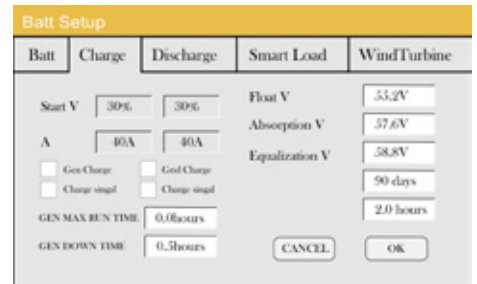

3. Untick grid charge

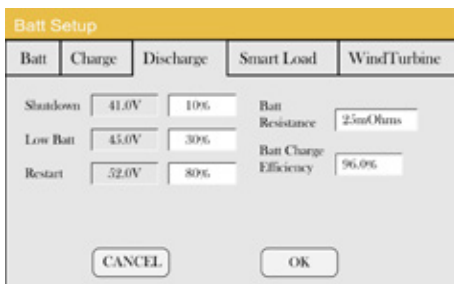

4. Set shutdown voltage

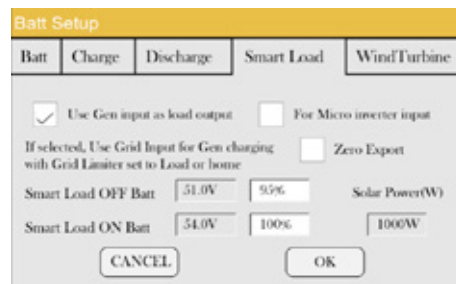

5. Tick use gen input and Load, set battery level and wattage \*\*

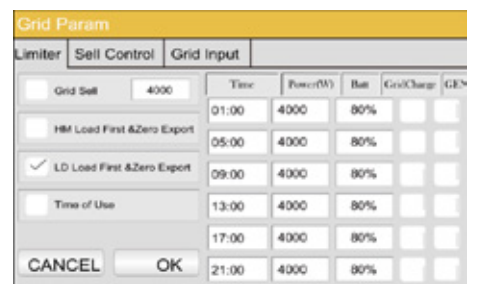

6. Set LD load

## 6.06 Off-Grid with Generator - MODES OF OPERATION

MODE 6 (off-grid with generator)

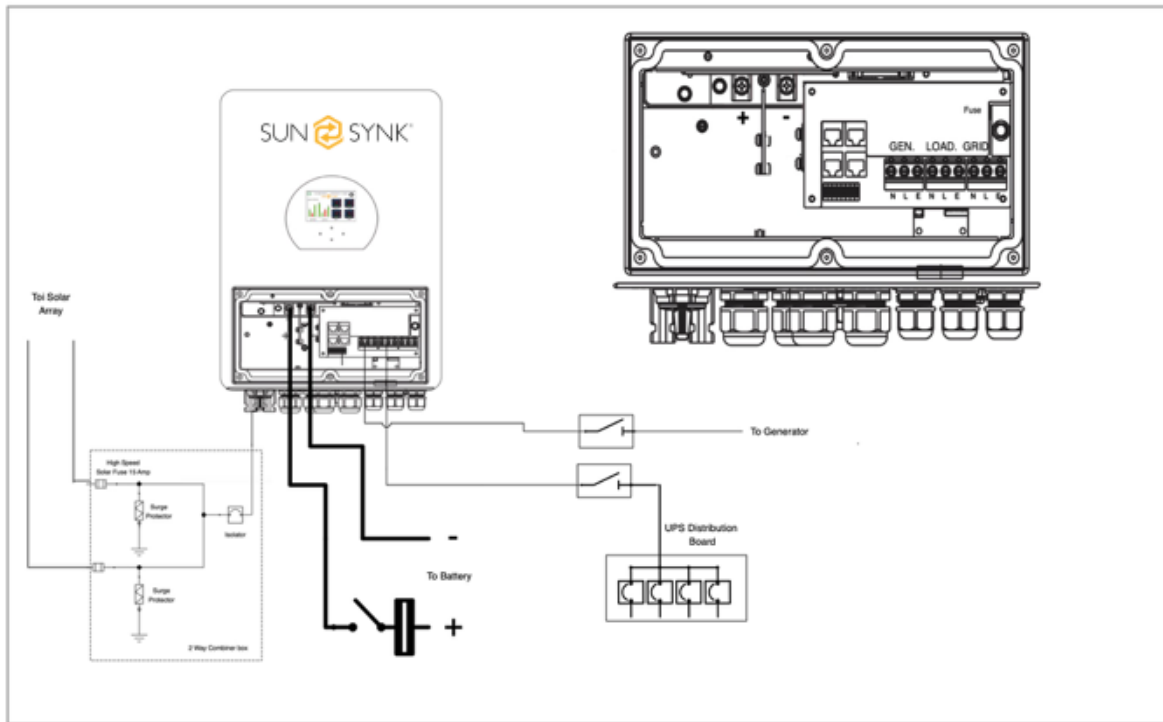

With the above system design we are able to take power directly from an engine's alternator and pass it onto the battery storage thereby reducing reliance on any generator. This will allow construction machines and marine vessels the ability of running electrical loads without burning fuel. When installing such a system an interface will be required and a design is located on the next page.

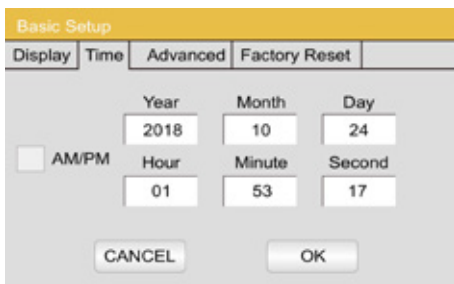

1. Set time and date

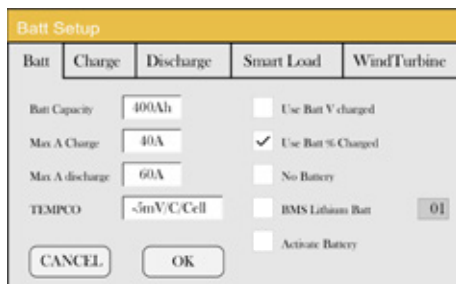

2. Set battery capacity

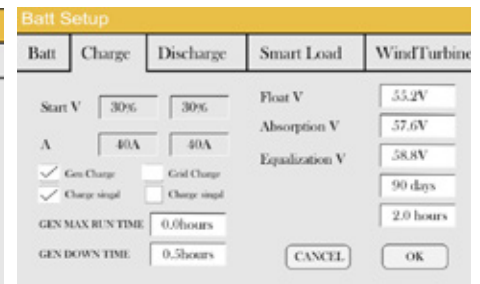

3. Tick gen charge and charge signal

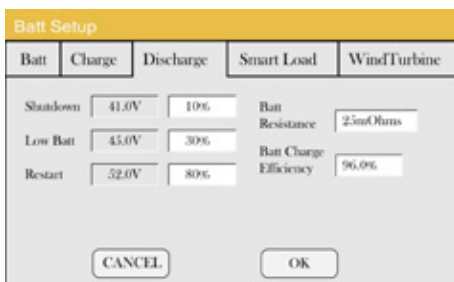

4. Set shutdown voltage

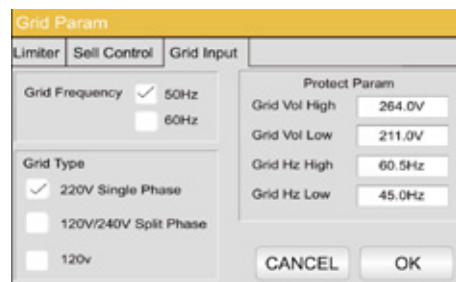

5. Set voltage and frequency



6. Set HM Load & zero export, set grid charge and discharge time

# Circuit Design of an Auto-Start for a Generator

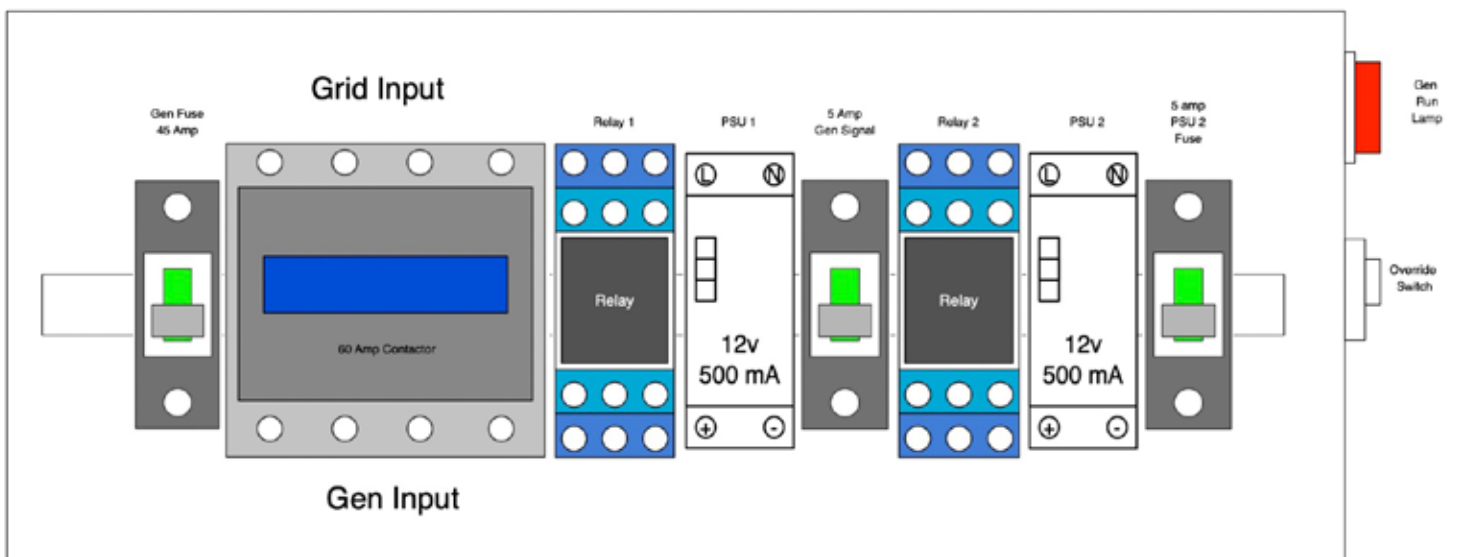
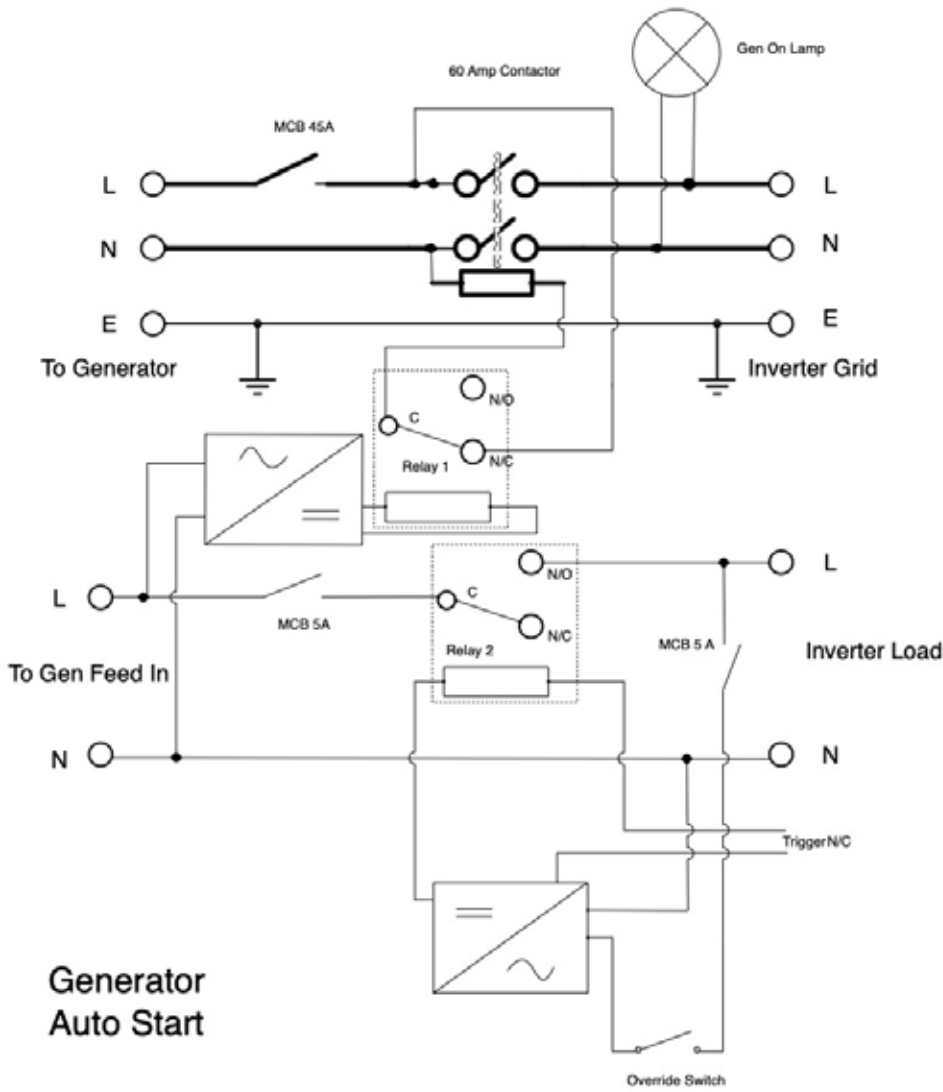

Quick Guide to LCD Operation



Each inverter has a unique ID displayed in the lower right corner:

- ID: Inverter series
- COMM: LCD firmware version
- MCU: Inverter firmware version



**Brightness** - Drag to adjust LCD brightness

**Auto Dim** - If selected LCD will dim after setting time expired.

**Beep** - If selected, inverter will alarm by beeping if fault detected. Check fault code on LCD when beep occurs.

Press 'OK' to set.

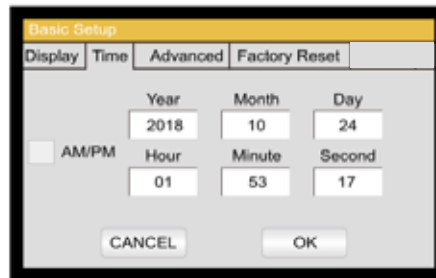

Set the system time, it offers 12hr and 24hr modes (touch the screen where change required and move number up & down via the up/down buttons.)

Press 'OK' to set.

Before conducting a successful factory reset and locking the system to keep all changes you need to type in a password.

Password: 9999 (factory) and 7777 (lock)



Switch on **gen peak shaving and grid peak shaving**. Set power at 8000 (example)

Press 'OK' to set.

Peak shaving is a technique to reduce electrical power consumption during periods of maximum demand on the power utility. This saves substantial amounts of money due to peak consumption charges.

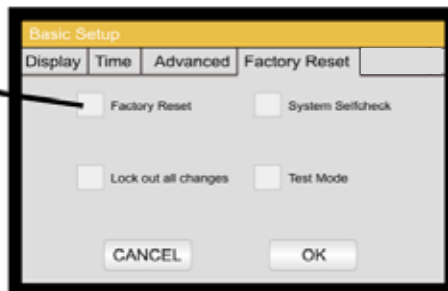
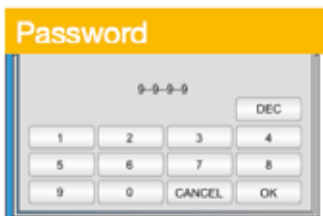

**Factory Reset** - Reset all parameters on inverter

**Lock out all changes** - Enable this menu for all setting parameters, which require locking, can not be re-set.

**System Selfcheck** - & test mode are reserved for engineers only.

### Quick Guide to LCD Operation (contd.)

**Battery Capacity:** Set the battery capacity depending on the nominal capacity of your battery bank. It does not matter even you connect with an old battery, because the inverter will learn the battery state after several cycles.

**Max A Charge:** Set the maximum charging current to the battery.

**Max A Discharge:** Set the maximum discharging current from the battery. (This value will be ignored in off grid-mode in order to offer constant power to loads).

**TEMPCO:** Temp setting compensation setting to adjust optimal voltages for lead-acid batteries, unless lithium battery are used. We put the most common parameter here, so we suggest to not change it.

**Use Batt V charged:** Showing battery charge by voltage.

**Use Batt % charged:** Showing battery charge by %.

**No Battery:** While no battery is connected, this hybrid can use as normal on grid inverter with solar panel array. Enable it by selecting no battery.

**BMS Lithium Batt (01):** Enable the specific communication of lithium battery with inverter.

**Activate Battery:** Activate lithium battery, when the BMS of the lithium battery is protected, battery will not power inverter or the inverter cannot charge the battery. Choose this function to activate the protection.

#### **IMPORTANT GUIDE TO BATTERY SETTINGS**

- **200Ah AGM battery - max A charge / max A discharge - 40Ah**
- **400Ah AGM battery - max A charge / max A discharge - 80Ah**
- **100Ah AGM battery - max A charge / max A discharge - 75Ah**
- **200Ah Li-Ion battery - max A charge / max A discharge - 100Ah**

Quick Guide to LCD Operation (contd.)

Batt Setup				
Batt	Charge	Discharge	Smart Load	WindTurbine
Start V	30%	30%	Float V	55.2V
A	40A	40A	Absorption V	57.6V
<input type="checkbox"/> Gen Charge	<input checked="" type="checkbox"/> Grid Charge	Equalization V	58.8V	90 days
<input type="checkbox"/> Charge singal	<input type="checkbox"/> Charge singal	GEN MAX RUN TIME	2.0 hours	0.0hours
GEN DOWN TIME	0.5hours	CANCEL		OK

Start V can be set to be read in % or voltage and is altered on previous batt setting page.

**If you select Gen Charge:-**

**Start V:** Voltage that the inverter will auto-start the generator to charge the battery.  
**Start %:** Percentage that inverter will auto-start the generator to charge the battery.  
**A:** Will be the charging value from the generator. Please set as per the generator specification.

**If you select gen charge:-**

**Start V:** Voltage that the inverter will auto-start the generator to charge the battery.  
**Start %:** Percentage that inverter will auto-start the generator to charge the battery.  
**A:** will be the charging value from the generator. Please set as per the generator specification.

**If you select grid charge:-**

**Start V:** Voltage that inverter will charge the battery from the grid. If grid is on, battery will stay at float voltage.  
**Start %:** Percentage that inverter will charge the battery from the grid. If grid is on, battery will stay at float voltage.  
**A:** Charging value from the grid.

**Charge Stages:** Depend on different battery type, we can set float V, absorption V, equalisation V (gap time between equalisation cycles and period time need for equalisation charge can be set by day and hour).

- Float 55.2V (the voltage at which the battery is maintained after being fully charged).
- Absorption 57.6V (the level of charge that can be applied without overheating the battery)
- Equalisation 58.8V (charge/overcharge to remove sulphate crystals that build up on the plates over time.)

*Do not run equalisation too often as it will damage the the battery.*

Batt Setup				
Batt	Charge	Discharge	Smart Load	WindTurbine
Shutdown	41.0V	10%	Batt Resistance	25mOhms
Low Batt	45.0V	30%	Batt Charge Efficiency	96.0%
Restart	52.0V	80%	CANCEL	
		OK		

Note: Shutdown takes the inverter to standby. It will not completely shut the inverter down. Total shutdown is below 19V.

**Shutdown:** Battery voltage at which the inverter will totally shut down.

**Low Batt:** Low battery voltage at which inverter will disconnect from the battery but will remain in standby mode.

**Restart:** Battery voltage at which the inverter will restart.

**Batt Resistance:** Used in % battery SOC calculation.

**Battery Charge Efficiency:** Used in % battery SOC calculation. If 'Use batt V charged' is selected, setting is depending on voltage. If 'Use batt % charged' is selected, setting is dependant on battery %.

**Note:** A fully charged battery should measure 12.6 volts or above. When charging, this measurement should be 13.7V to 14.7V. If the battery is not fully charged, it will diminish to 12.4V at 75%, 12V at 25% and up to 11.9V when it's completely discharged.



Quick Guide to LCD Operation

Sunsynk Parity Inverter Charge Voltage

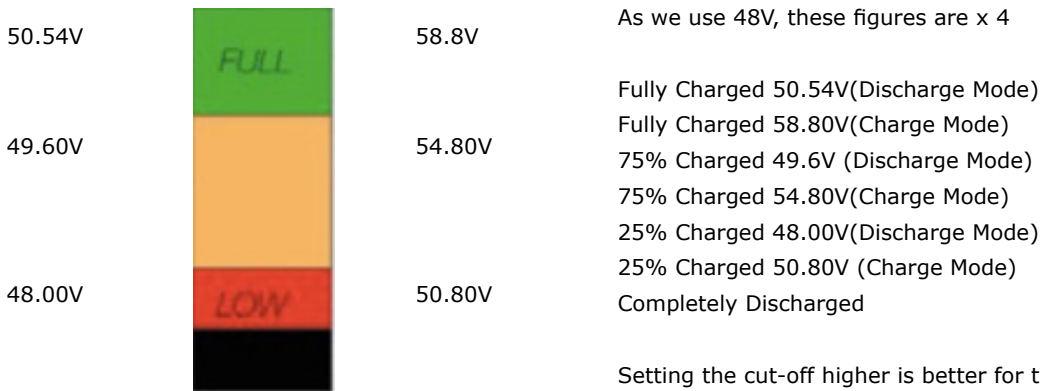

Setting the cut-off higher is better for the batteries.

The batteries normally used in the recommended Sunsynk systems are AGM lead acid or lithium battery bank. ('AGM' The Absorbed Glass Matt construction allows the electrolyte to be suspended in close proximity with the plates active material. In theory, this enhances both the discharge and recharge efficiency.)

**State of Charge**

**BULK:** Stage involves about 80% of the recharge, wherein the charger current is held constant (in a constant current charger), and voltage increases. The properly sized charger will give the battery as much current as it will accept up to charger capacity (25% of battery capacity in amp hours).

**ABSORPTION:** (the remaining 20%, approximately) has the charger holding the voltage at the charger’s absorption voltage (between 14.1 VDC and 14.8 VDC, depending on charger set points) and decreasing the current until the battery is fully charged.

**FLOAT:** The charge voltage is reduced to between 13.0 VDC and 13.8 VDC and held constant, while the current is reduced to less than 1% of battery capacity. This mode can be used to maintain a fully charged battery indefinitely.

**EQUALISATION:** This is essentially a controlled over charge (the peak voltage the charger) attains at the end of the BULK mode (absorption voltage) an equalisation voltage, but technically it’s not. Higher capacity wet (flooded) batteries sometimes benefit from this procedure, particularly the physically tall batteries. The electrolyte in a wet battery can stratify over time, if not cycled occasionally. In equalisation, the voltage is brought up above typical peak charging voltage well into the gassing stage, and held for a fixed (but limited) period. This stirs up the chemistry in the entire battery, “equalising” the strength of the electrolyte, and knocking off any loose sulphating that may be on the battery plates.

## Appendix A-5

A 'smart load' is a setting that draws excess power when the battery storage is full and passes it to household utilities such as water heaters and air conditioners.

The screenshot shows the 'Batt Setup' menu with the following options and values:

- Use Gen input as load output
- For Micro inverter input
- If selected, Use Grid Input for Gen charging with Grid Limiter set to Load or home
- Zero Export
- Smart Load OFF Batt: 51.0V, 95%
- Smart Load ON Batt: 54.0V, 100%
- Solar Power(W): 1000W

Buttons: CANCEL, OK

Use gen (Aux) Input as Load Input: This mode will utilise the gen-input connection as load output connection which only uses the battery power when the battery voltage is above the set threshold or use grid power when the grid is on. When this function is selected, the user can connect loads to the gen (Aux) input connector.

**Smart Load OFF Batt:** Battery voltage at which the gen (Aux) load will stop being powered.

**Smart Load ON Batt:** Battery voltage at which the gen load will start being powered. Battery power will be used by load on gen (Aux) load and can be programmable.

**For Micro Inverter Input:** This mode will utilise the gen (Aux) Input to connect the micro-inverter AC output. So micro-inverter generated power can also be used to charge battery or sell to grid.

The screenshot shows the 'Batt Setup' menu with the following options and values:

- DC1 for WindTurbine
- DC2 for WindTurbine
- V1: 0V, 0.0A
- V2: 0V, 0.0A
- V3: 0V, 0.0A
- V4: 0V, 0.0A
- V5: 0V, 0.0A
- V6: 0V, 0.0A
- V7: 0V, 0.0A
- V8: 0V, 0.0A
- V9: 0V, 0.0A
- V10: 0V, 0.0A
- V11: 0V, 0.0A
- V12: 0V, 0.0A

Buttons: OK, CANCEL

If one or both MPPTs are being used for corresponding wind turbines - tick the correct boxes.

The profile of the wind turbine (obtained from the turbine) can be set. The higher the voltage the faster the wind turbine. As the turbine goes faster we can increase the current draw which acts as a braking system.

### 3-Phase HV Wind Turbine    3-Phase Bridge Rectifier    Double Pole Isolator + Fuse

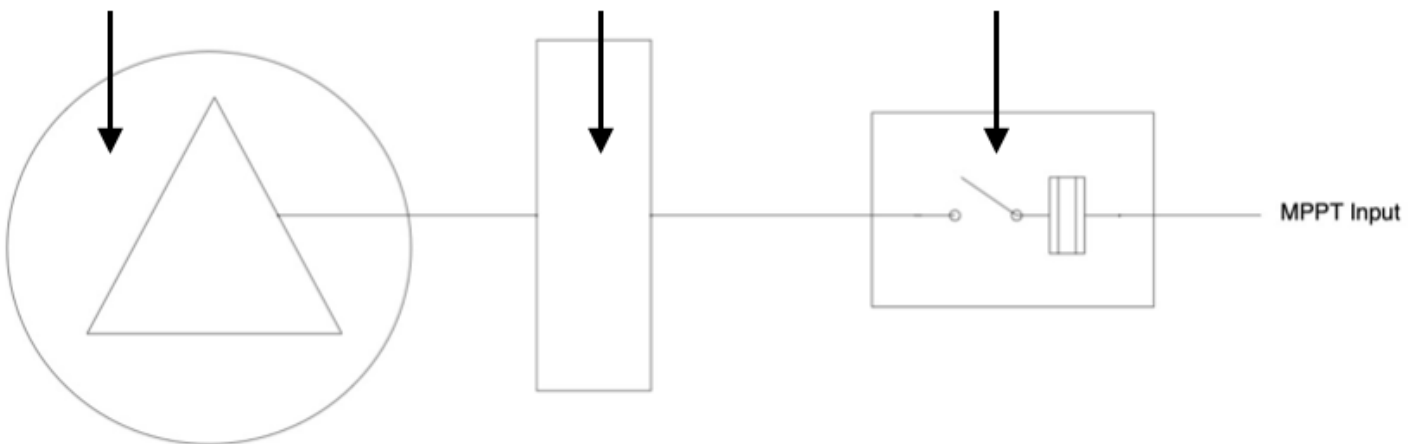

Quick Guide to LCD Operation

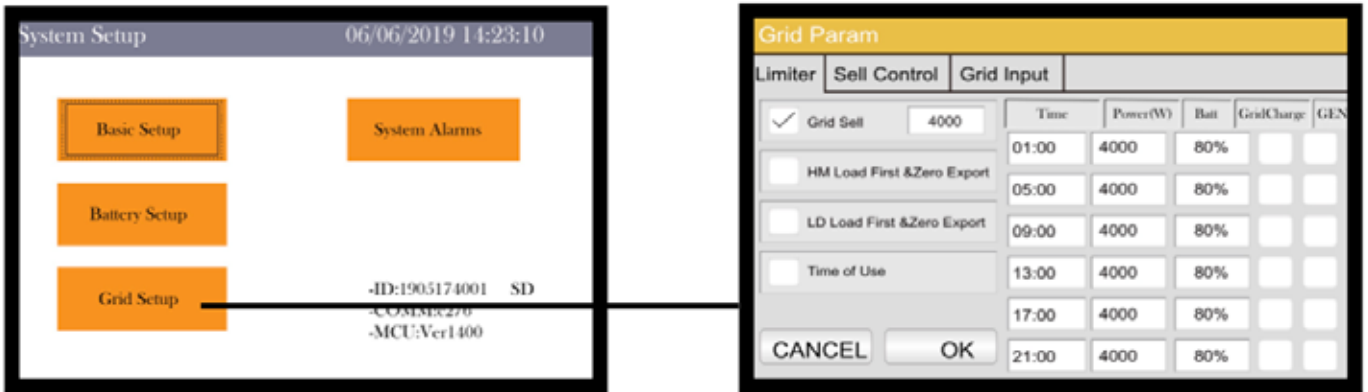

- Time is real time when battery will charge or discharge
- Power is the power limiter
- Batt is the 80% which can discharge
- Grid charge tick to charge from grid
- Gen charge tick to charge from
- Un-Tick is the time of discharge
- HM load first & zero export - Limits the power produced by the inverter to match the consumption of the home loads.
- LD load first & zero export - Limits the power produced by the inverter to match the consumption of the connected loads to inverter load & gen. output.

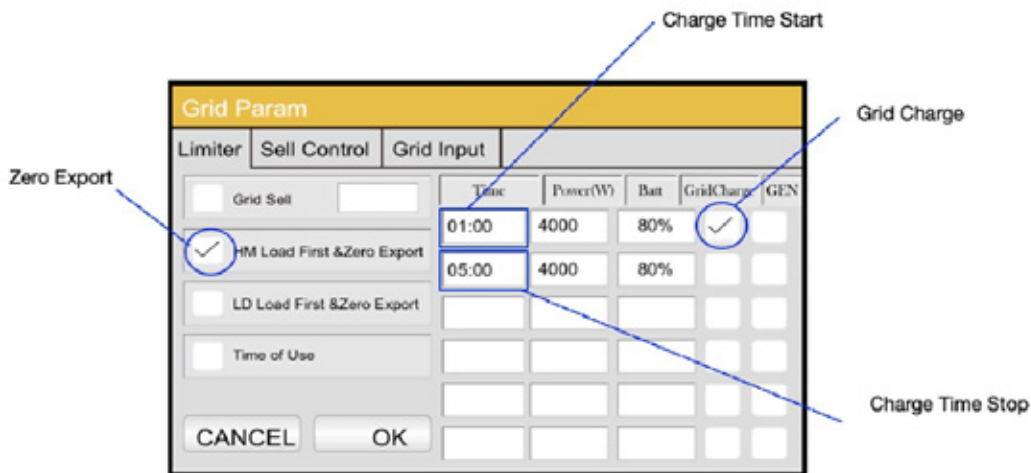

This setting is used when you need the battery to charge at certain times each day or need the battery to discharge at a specific time each day.

Quick Guide to LCD Operation

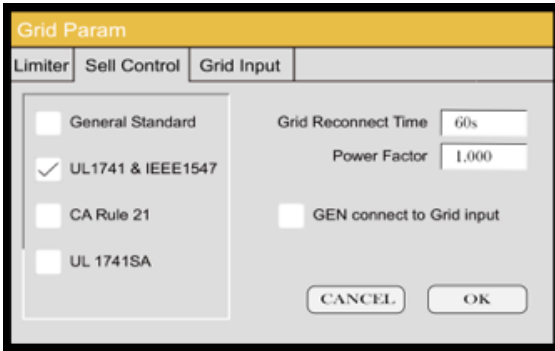

**Sell Control**

- Grid reconnect time after loss of grid. (60s is default setting)
- Power factor compensation.
- Tick if connecting gen to grid input.
- One of the four standard boxes must be ticked otherwise the user must set voltage and frequency on setting page.

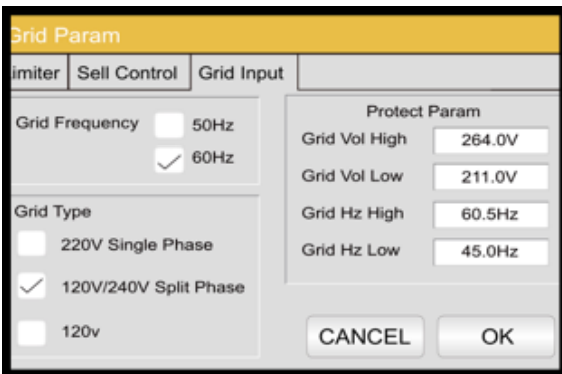

**Non USA Settings:**

- Grid set-up grid frequency 50Hz
- 230V single phase
- Grid high voltage 240V, grid low 200V
- Grid Hz high 50.60 Hz low 49.50Hz
- Grid frequency: choose the frequency of the grid which connect to the inverter. (Normally 50Hz)
- Grid type: 220V single-phase is mainly for Asia, Europe and other 220V grid areas. 120V/240V split-phase is for North America and some central America areas. (120V/208V 2/3 phase is waiting to be enabled in future.)
- Protect parameters: Programmable high & low voltage when inverter is connected to the grid. This setting cannot be enabled when UL 1741 & IEEE 1547.



System Alarms		06/06/2019 14:23:10
Alarms Code	Occurred	
F56 DC_VoltLow_Fault	2018-10-24 01:07	
F56 DC_VoltLow_Fault	2018-10-24 01:07	
F56 DC_VoltLow_Fault	2018-10-24 01:00	
F56 DC_VoltLow_Fault	2018-10-24 00:55	
F56 DC_VoltLow_Fault	2018-10-24 00:43	
F56 DC_VoltLow_Fault	2018-10-24 00:10	
F56 DC_VoltLow_Fault	2018-10-24 00:08	
F56 DC_VoltLow_Fault	2018-10-24 00:07	

If the inverter shows the fault code the fault info will be displayed in this page.

Fault Information	Instruction	Fault Information	Instruction
F01	DC_Inversed_Failure	F33	AC_OverCurr_Fault
F02	DC_Insulation_Failure	F34	AC_Overload_Fault
F03	GFDI_Failure	F35	AC_NoUtility_Fault
F04	GFDI_Ground_Failure	F36	AC_GridPhaseSeque_Fault
F05	EEPROM_Read_Failure	F37	AC_Volt_Unbalance_Fault
F06	EEPROM_Write_Failure	F38	AC_Curr_Unbalance_Fault
F07	GFDI_Fuse_Failure	F39	INT_AC_OverCurr_Fault
F08	GFDI_Relay_Failure	F40	INT_DC_OverCurr_Fault
F09	IGBT_Failure	F41	AC_WU_OverVolt_Fault
F10	AuxPowerBoard_Failure	F42	AC_WU_UnderVolt_Fault
F11	AC_MainContactor_Failure	F43	AC_VW_OverVolt_Fault
F12	AC_SlaveContactor_Failure	F44	AC_VW_UnderVolt_Fault
F13	Working_Mode_change	F45	AC_UV_OverVolt_Fault
F14	DC_OverCurr_Failure	F46	AC_UV_UnderVolt_Fault
F15	AC_OverCurr_Failure	F47	AC_OverFreq_Fault
F16	GFCI_Failure	F48	AC_UnderFreq_Fault
F17	Tz_COM_OC_Fault	F49	AC_U_GridCurr_DcHigh_Fault
F18	Tz_Ac_OverCurr_Fault	F50	AC_V_GridCurr_DcHigh_Fault
F19	Tz_Integ_Fault	F51	AC_W_GridCurr_DcHigh_Fault
F20	Tz_Dc_OverCurr_Fault	F52	AC_A_InductCurr_DcHigh_Fault
F21	Tz_GFDI_OC_Fault	F53	AC_B_InductCurr_DcHigh_Fault
F22	Tz_EmergStop_Fault	F54	AC_C_InductCurr_DcHigh_Fault
F23	Tz_GFCI_OC_Fault	F55	DC_VoltHigh_Fault
F24	DC_Insulation_Fault	F56	DC_VoltLow_Fault
F25	DC_Feedback_Fault	F57	AC_BackFeed_Fault
F26	BusUnbalance_Fault	F58	AC_U_GridCurr_High_Fault
F27	DC_Insulation_ISO_Fault	F59	AC_V_GridCurr_High_Fault
F28	DCIOver_M1_Fault	F60	AC_W_GridCurr_High_Fault
F29	AC_AirSwitch_Fault	F61	AC_A_InductCurr_High_Fault
F30	AC_MainContactor_Fault	F62	AC_B_InductCurr_High_Fault
F31	AC_SlaveContactor_Fault	F63	ARC_Fault
F32	DCIOver_M2_Fault	F64	Heatsink_HighTemp_Fault

**Fault List :-**

If any of the fault messages listed in the above table appear on the Inverter and the fault has not been removed after restarting, please contact your local dealer or service centre.

1. Inverter serial number.
2. Distributor or service centre of the inverter.
3. On-grid power generation date.
4. The problem description (including the fault code and indicator status displayed on the LCD) is as detailed as possible.
5. Your contact information.



ID:1905174001

06/06/2019 14:23:10

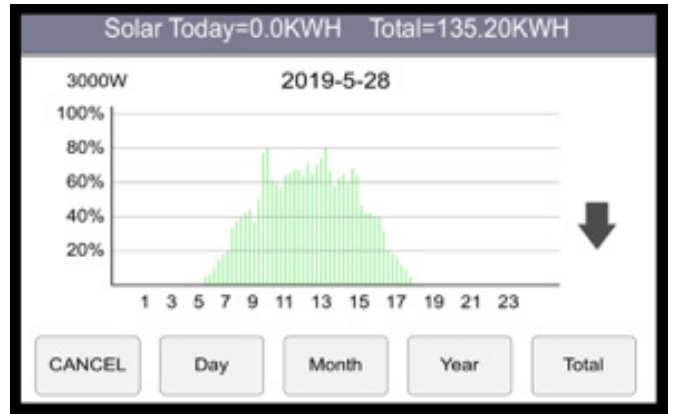
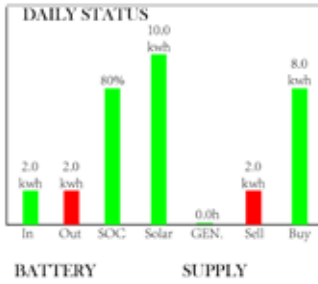

You can access :-

- Daily solar power
- Monthly accumulative solar power
- Yearly accumulative solar power
- Total accumulative solar power

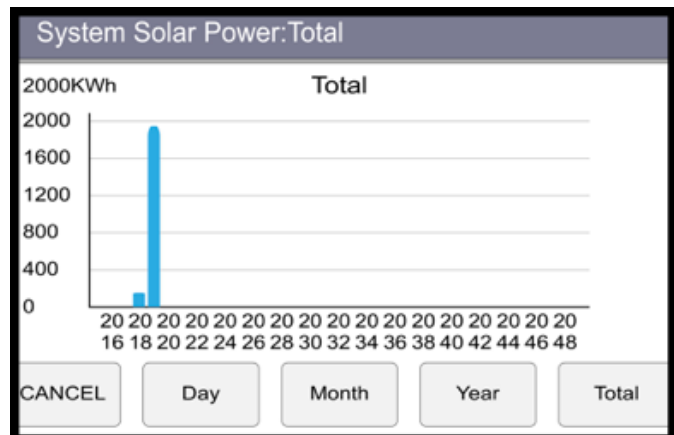
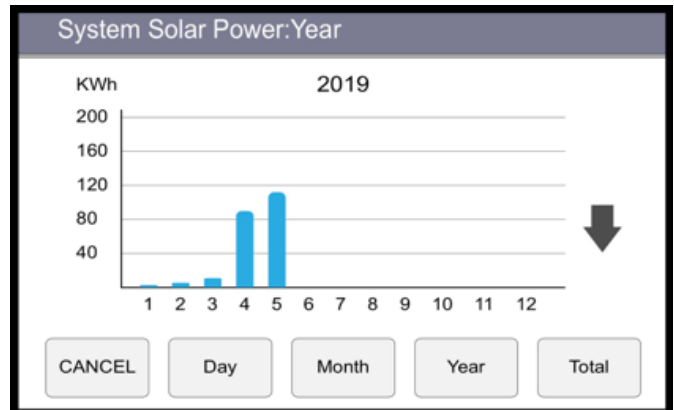
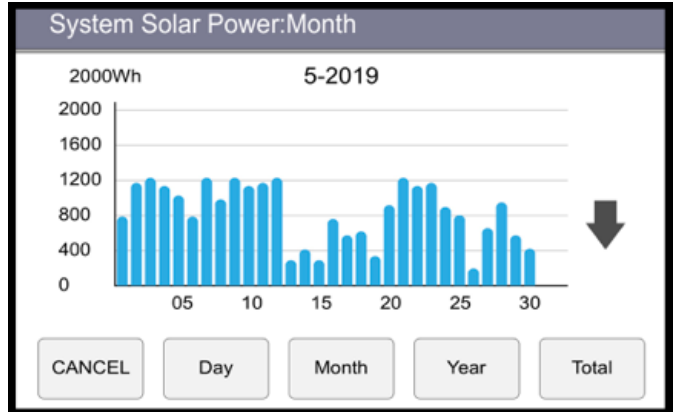



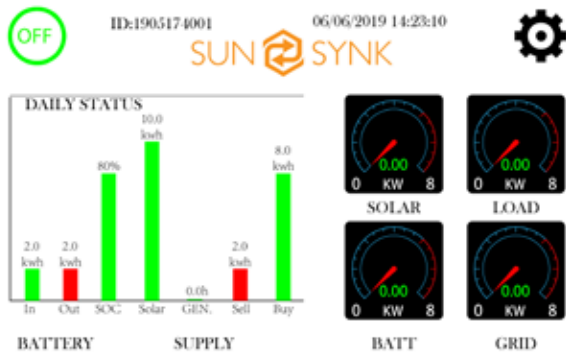

Solar	Grid	INV	Load	Batt
447W	0W	0W	0W	-402W
	50Hz	50Hz		52%
L1:272V	0V	230V	230V	50.05V
0.7A	0A	0.0A		-8.04A
216W	HM:0W			24.8C
L2:286V	LD:0W			
0.8A				DC:54.6C
231W				AC:33.8C

**Status Page**

**Solar Column:** Shows total solar PV power at top and then details of each of the two MPPTs below: LI & L2 voltage

**Grid Column:** Shows grid total power. Frequency, voltage and current. If selling to the grid, grid power is negative. If taking from grid, grid power is positive.

If the value of grid and HM powers are not the same when PV is disconnected and the inverter is only taking energy from the grid and If using the HM CT connected to Limit - 2 then please reverse the polarity of the HM current sensor. IMPORTANT: see section on CT coil

**Inverter Column:** It shows inverter total power, frequency, LI & L2 voltage, current and power.

**Load Column:** It shows load total power and load voltage & power on LI & L2.

**Battery Column:** It shows total power from battery, battery SOC, battery voltage, battery current (negative means charge, positive means discharge), battery temperature (It will show zero if battery temp, sensor is not connected). DC transformer temp and AC heat-sink temperature when temperature reaches 90°C, it will show red and start derating when reaching 110°C, inverter will shutdown to allow it to cool.





Web: [www.sunsynk.com](http://www.sunsynk.com) Email: [sales@globaltech-china.com](mailto:sales@globaltech-china.com)