



## INSTRUCTIVO DE ARMADO

Diseño  
**JOY**



## PIEZAS Y TORNILLERIA

**4** Tornillos de 100 mm

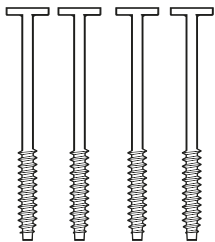

**4** Barriles

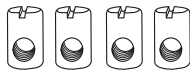

**8** Tornillos de 60 mm

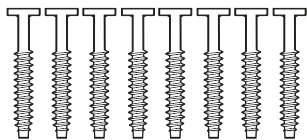

**8** Contras



**2** Llaves Allen

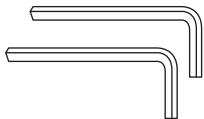

**1** Llave Española

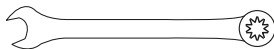

**1** Asiento (brazos ya vienen ensamblados al asiento)

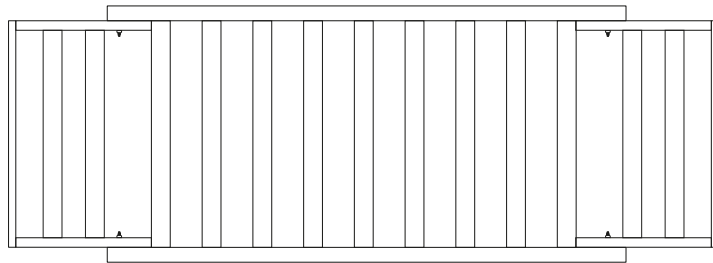

**2** Patas para base

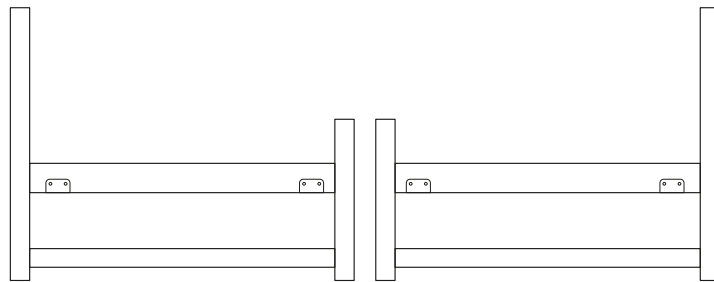

**1** Larguero



## ENSAMBLE

### PASO 1

Acomodar "patas base" y "larguero",  
poner barriles y después  
tornillos de 100 mm, apretar  
con llave allen.

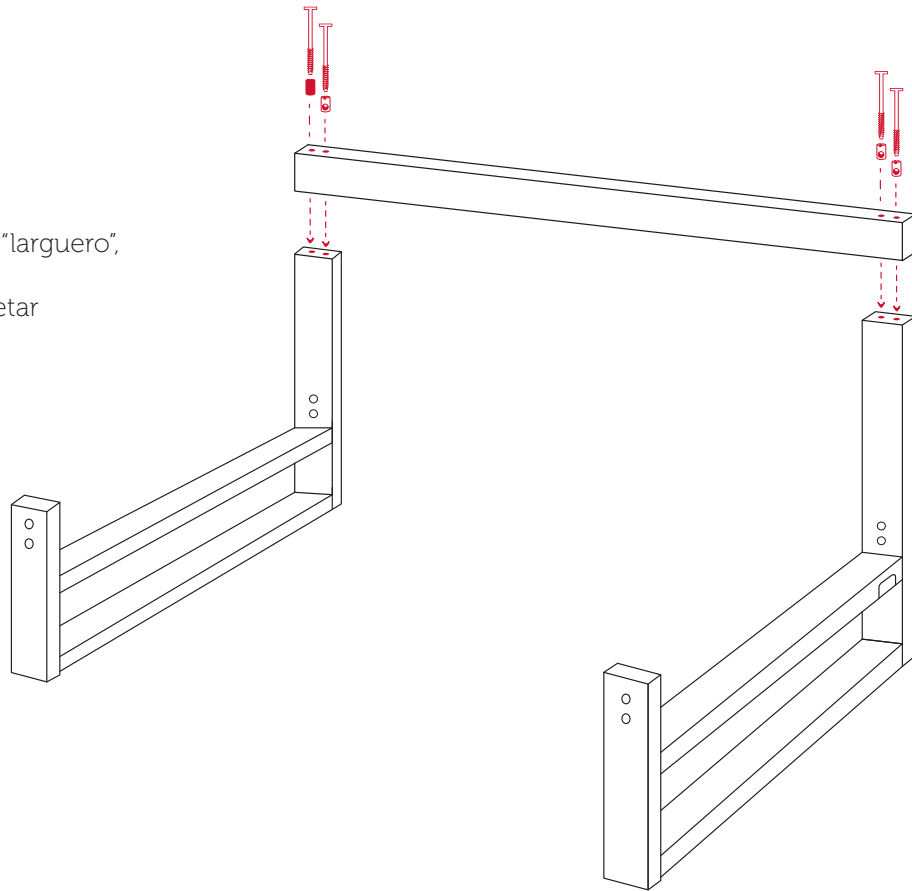

## ENSAMBLE

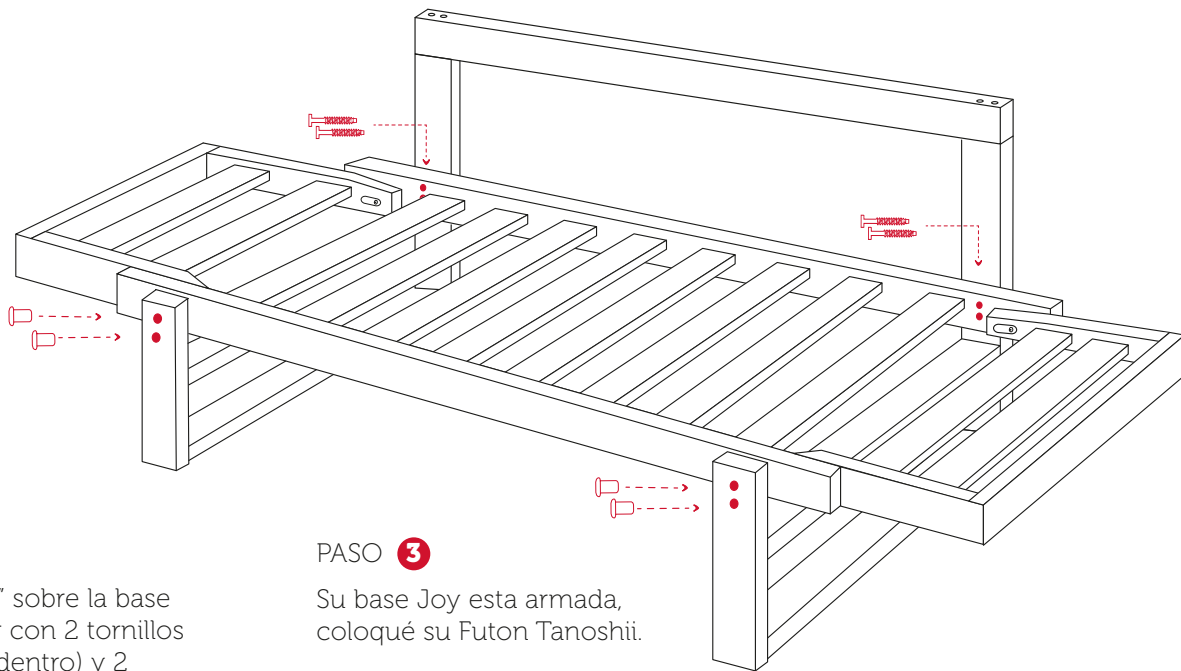

### PASO 2

Poner el "asiento" sobre la base armada, atornillar con 2 tornillos de 60 mm (por adentro) y 2 contras (por afuera) **en cada lado**. Ajustar toda la tornillería.

### PASO 3

Su base Joy está armada, coloque su Futon Tanoshii.

## INSTRUCTIVO DE MOVIMIENTO

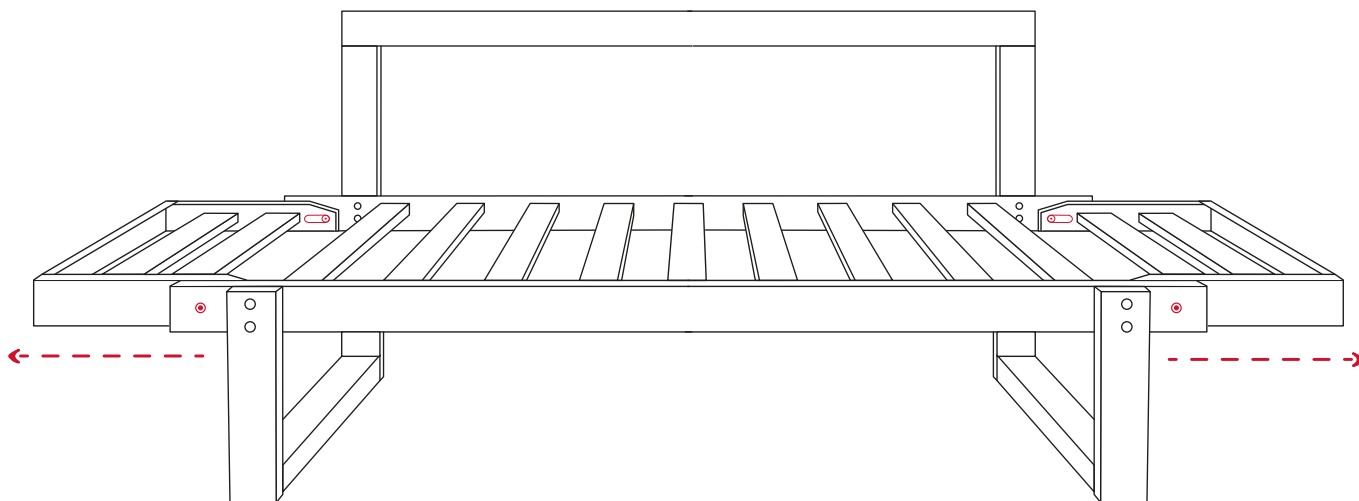

### DE CAMA A SOFÁ

#### PASO 1

Para convertirlo de cama a sofá  
jale los brazos para quitar los seguros.

## INSTRUCTIVO DE MOVIMIENTO

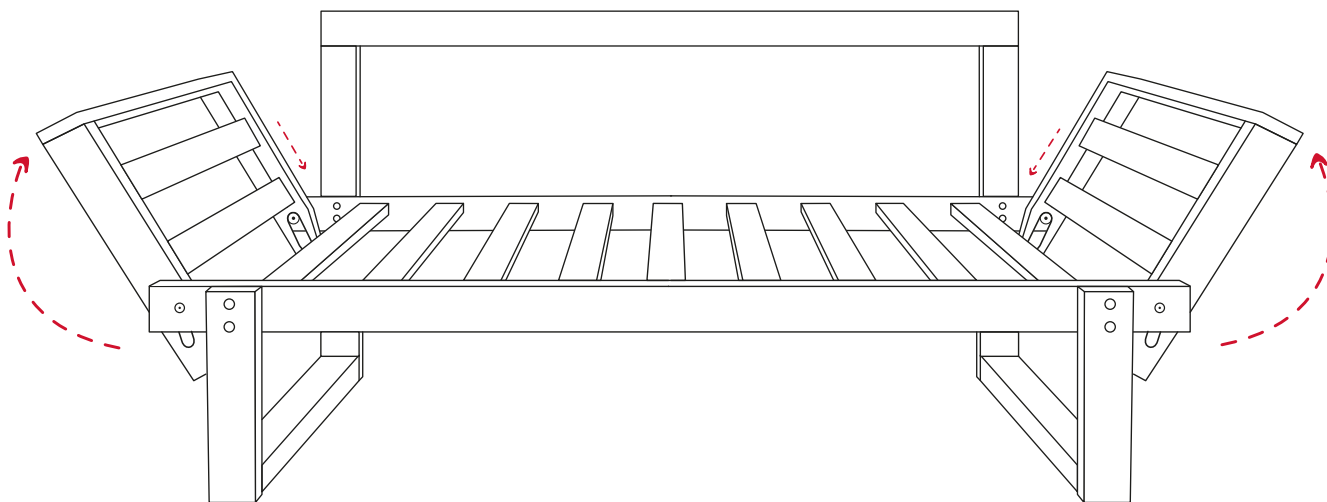

### DE CAMA A SOFÁ

#### PASO 2

Suba los brazos y asegure bajando en 45°.

## INSTRUCTIVO DE MOVIMIENTO

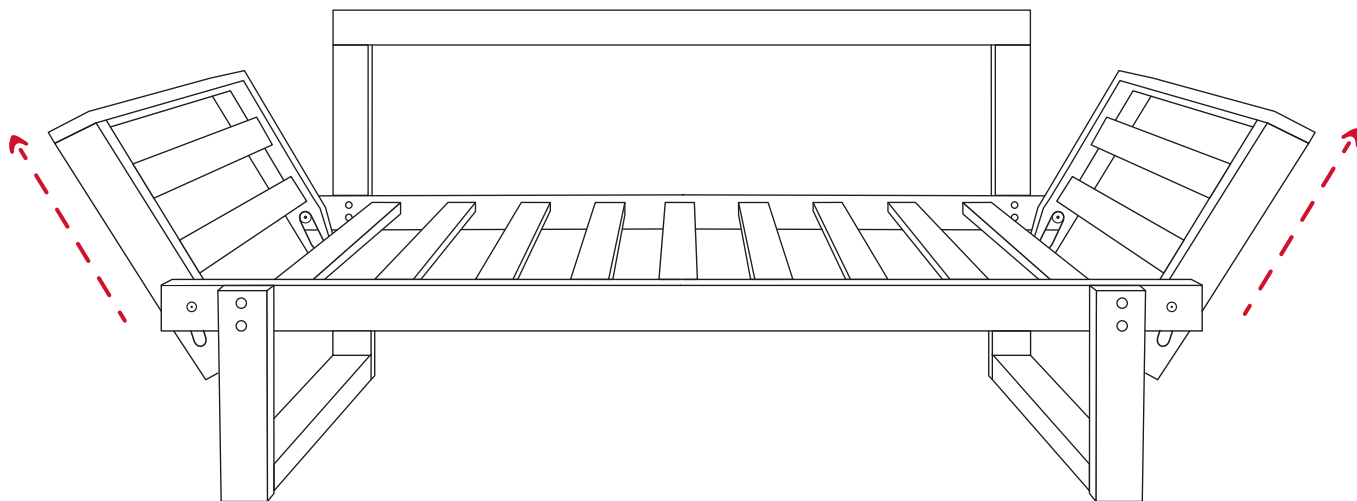

### DE SOFÁ A CAMA

#### PASO 1

Para hacerla cama suba los brazos y desasegurar.

## INSTRUCTIVO DE MOVIMIENTO

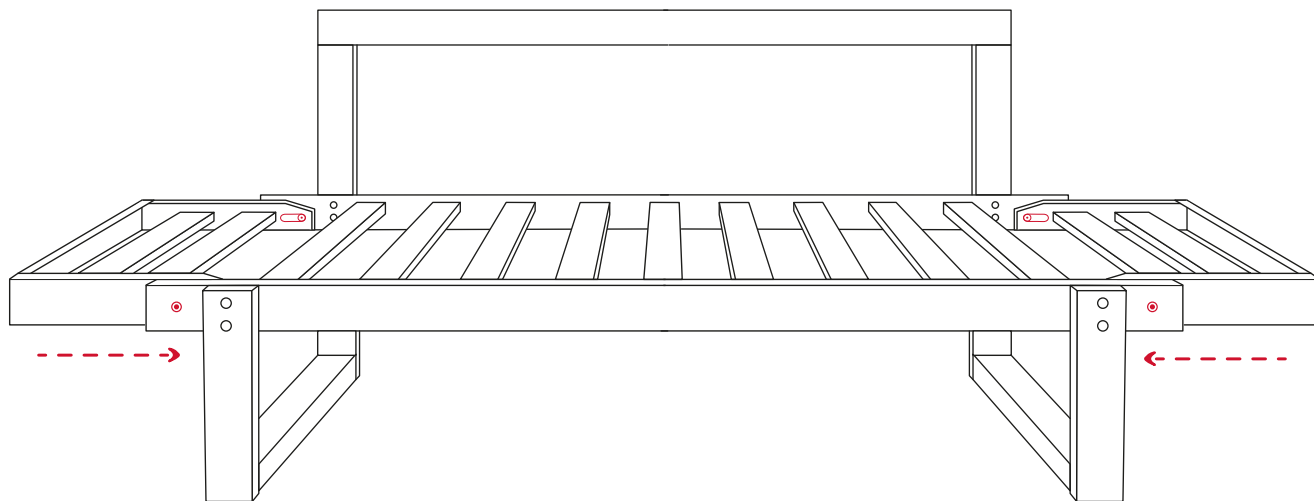

### DE SOFÁ A CAMA

#### PASO 2

Después bajar los brazos y meterlos para asegurar.





### **Polanco**

Homero 1132  
Col. Polanco  
52 03 41 38

### **Santa Fe**

Centro comercial  
"Santa Fe" 2° Piso  
52 58 07 68

### **Altavista**

Altavista 117,  
Col. San Angel Inn,  
56 16 33 81

**[www.futontanoshii.com](http://www.futontanoshii.com)**