

Product Code 07
340mm Internal (Concave) Plinth

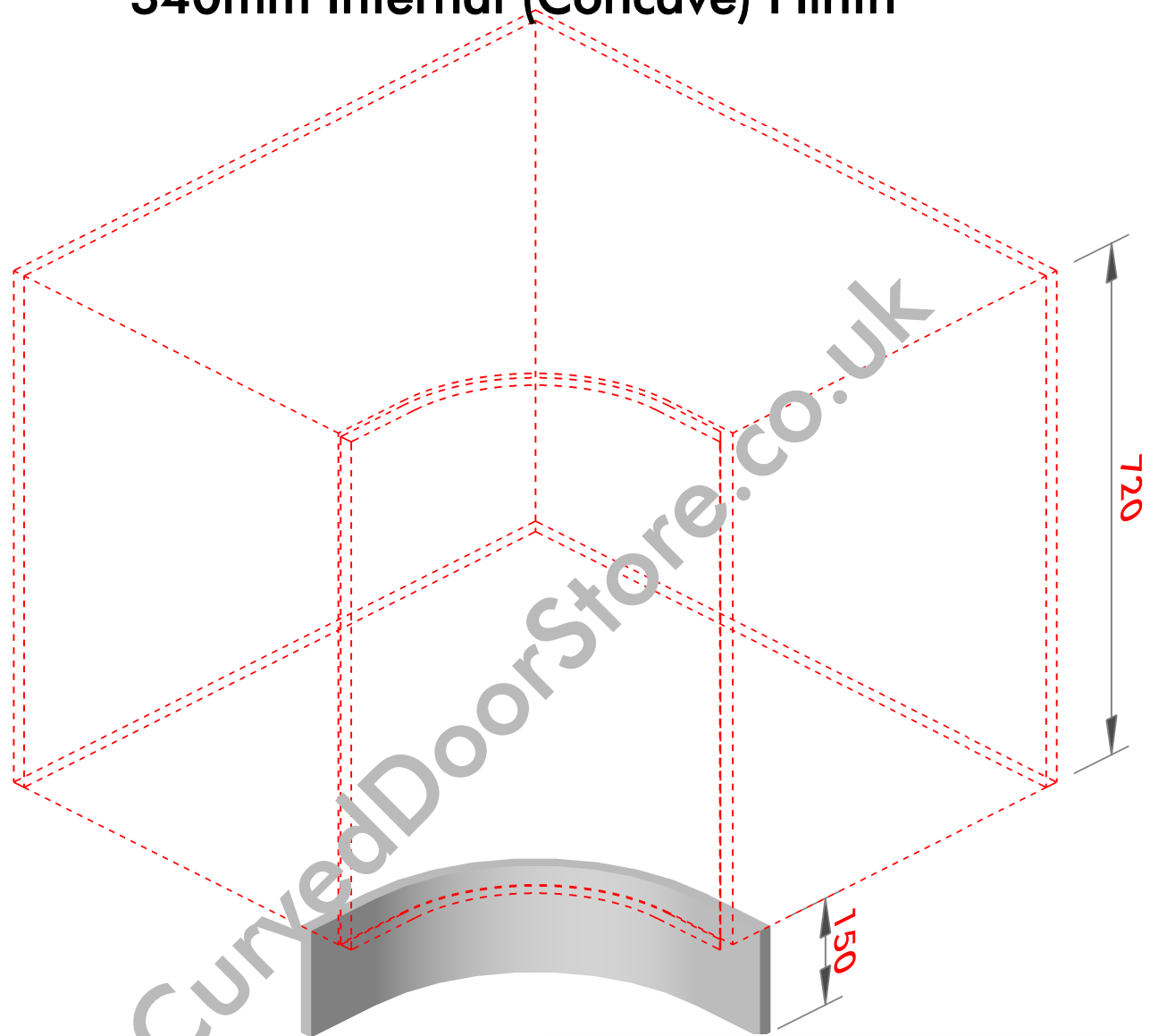

3D VIEW
(All sizes in mm)

